



RSA-G2 SOLIDS ANALYZER



RSA-G2 Solids Analyzer

The RSA-G2 is the most advanced platform for mechanical analysis of solids. The separate motor and transducer technology of the RSA-G2 ensures the purest mechanical data through independent control of deformation and measurement of stress. It is capable of performing the most accurate DMA measurements as well as many additional experiments including creep and recovery, stress relaxation, stress ramps, strain rate ramps, iso-strain, iso-force, fatigue, multiwave, arbitrary waveform, and dielectric thermal analysis. With such a broad range of solid analysis techniques, the RSA-G2 is uniquely positioned to address the widest range of applications from the R&D bench to the quality control lab. This high-performance instrument is the fourth generation of dual-head mechanical analyzers, featuring a new forced convection oven for precise and accurate temperature control, extensive array of clamping systems to accommodate the widest range of sample shapes and stiffness, and immersion testing capability. In addition, the RSA-G2 doubles as a DETA, or Dielectric Thermal Analyzer, for stand-alone or simultaneous measurements.

DEFORMATION OF SOLIDS | THEORY

The Benefits of Rheology

Solid and soft solid materials encounter a range of mechanical deformations (stresses and strains) over a wide variety of environmental conditions in practical daily use. This is important for nearly every industry, including aerospace, asphalt, automotive, ceramics, elastomers, electronics, food, personal care, biomedical, paints and other coatings, pharmaceuticals, metals, etc. The deformations experienced can be static or cyclic in nature, and the environments can be moderate to extreme temperatures, temperature cycling, or exposure to different liquids such as water or oil. The increasing demands for high quality, high performing products makes it vitally important to understand the complex viscoelastic mechanical properties of these materials to determine and ensure their suitability for applications, processability, and end-use performance. The RSA-G2 is the ideal platform for fully characterizing and understanding complex mechanical behavior of solids.

The RSA-G2 can be used for the widest range of traditional and advanced mechanical measurements and applications including:

- Modulus of Elasticity (E)
- Modulus of Rigidity (G)
- Complex Moduli (E*, G*)
- Storage and Loss Moduli (E', E'', G', G'')
- Damping Properties (tan δ)
- Frequency Effects
- Creep and Recovery
- Stress Relaxation
- Glass Transition Temperature
- Secondary Transitions
- Crystallization
- Softening and Melting Temperature
- Time-temperature Superposition
- Molecular Weight / Cross-linking
- Phase Separation (Polymer Blends, Copolymers, ...)
- Composites
- Aging (physical or chemical)
- Curing of Networks
- Gelation
- Cross-linking Reactions
- Cross-link Density
- Orientation Effects
- Effects of Additives
- Resiliency
- Stress-strain Curves
- Shrink Force
- Mullins Effect
- Dynamic Fatigue
- Impact Strength
- Toughness

The RSA-G2 imposes a mechanical deformation on a specimen and measures the resulting stress response. The science concerned with the study of deformation and flow of materials is called rheology. Deformation is the relative change in shape of a body, or STRAIN, under the influence of an external force, or STRESS. Flow is a continuous relative change in shape per unit time, or STRAIN RATE, under influence of external STRESS. The RSA-G2 is in fact a linear rheometer, or a precision instrument, which contains a specimen of the material of interest in a geometric configuration, controls the environment around it, and applies and measures wide ranges of STRESS, STRAIN, and STRAIN RATE. An alternative definition of rheology, relating more directly to the function of the rheometer, is the study of stress-strain or stress-strain rate relationships. The material response to external forces can be purely viscous or Newtonian behavior, purely elastic or Hookean behavior, or a combination of both. Nearly all commercial materials of interest respond with a combination of viscous and elastic behavior and are referred to as viscoelastic materials. Scientists use the RSA-G2 and rheology theory to study these rigid solid, soft solid, and highly viscous liquid materials in terms of a variety of material parameters such as modulus, compliance, and elasticity. Modulus is a measure of a material's overall resistance to deformation. Compliance is a measure of the material's ability to respond to a mechanical deformation. Elasticity is a measure of a material's ability to store deformational energy. The RSA-G2 is capable of applying a variety of deformation types over a wide range of temperatures and time-scales, and calculates these material parameters providing a wealth of information about a material's structure-property relationships and its performance characteristics.

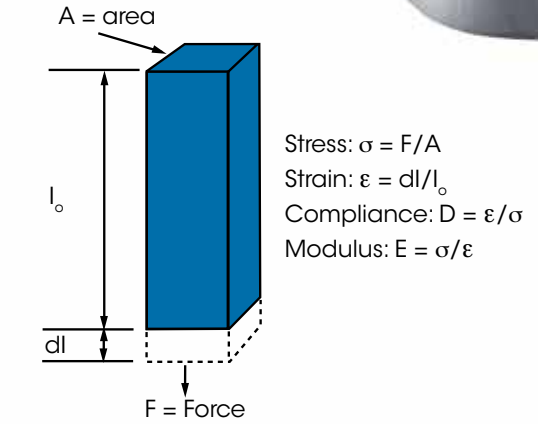

RSA-G2 | TECHNOLOGY

The RSA-G2 Provides Independent Measurements of Stress and Strain

When it comes to making the most accurate mechanical measurements, two heads are better than one! The mechanical behavior of solid polymers and other materials is described by material functions such as the modulus or compliance. The modulus is the ratio of stress to strain and the compliance is the ratio of strain to stress. In order to make the purest and most accurate viscoelastic measurements, it is best to measure the fundamental parameters of stress and strain independently. This approach, taken by the TA Instruments RSA-G2, leads to measurements free of instrument artifacts over wide ranges of stress, strain, and frequency.

RSA-G2 Design Advantage

At the heart of the RSA-G2 dual-head solids analyzer is the high-performance drive motor and unique transducer. The sample is deformed from the bottom by a direct-drive DC-Servo motor featuring all new electronic DSP control. The force generated in the sample is measured at the top by the patented Force Rebalance Transducer (FRT). The RSA-G2 FRT incorporates a highly sensitive position sensor and linear motor with temperature-compensated rare-earth magnets to ensure the most accurate force measurements. The FRT directly measures sample force from the current required to drive the linear motor in the transducer to maintain zero position. Both the drive motor and transducer incorporate precision air bearings for stiff and frictionless support of linear motion and enhanced force sensitivity. The independent force measurement eliminates motor friction and inertia corrections and translates to the purest force measurement available.

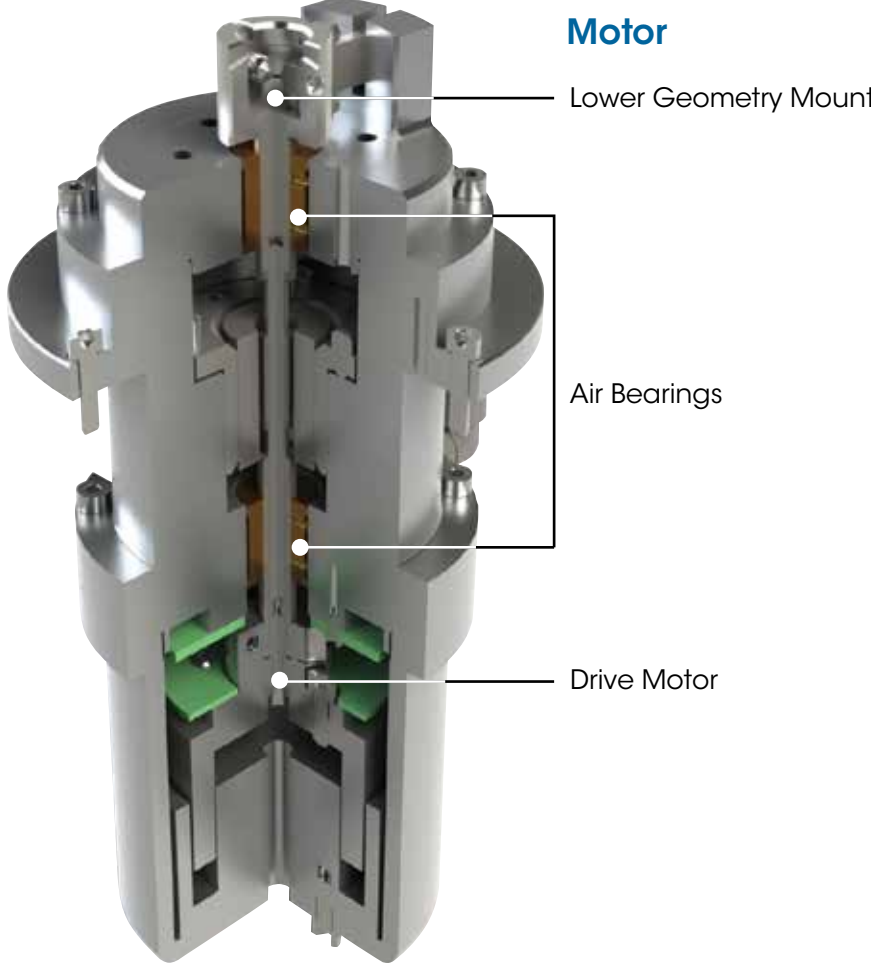
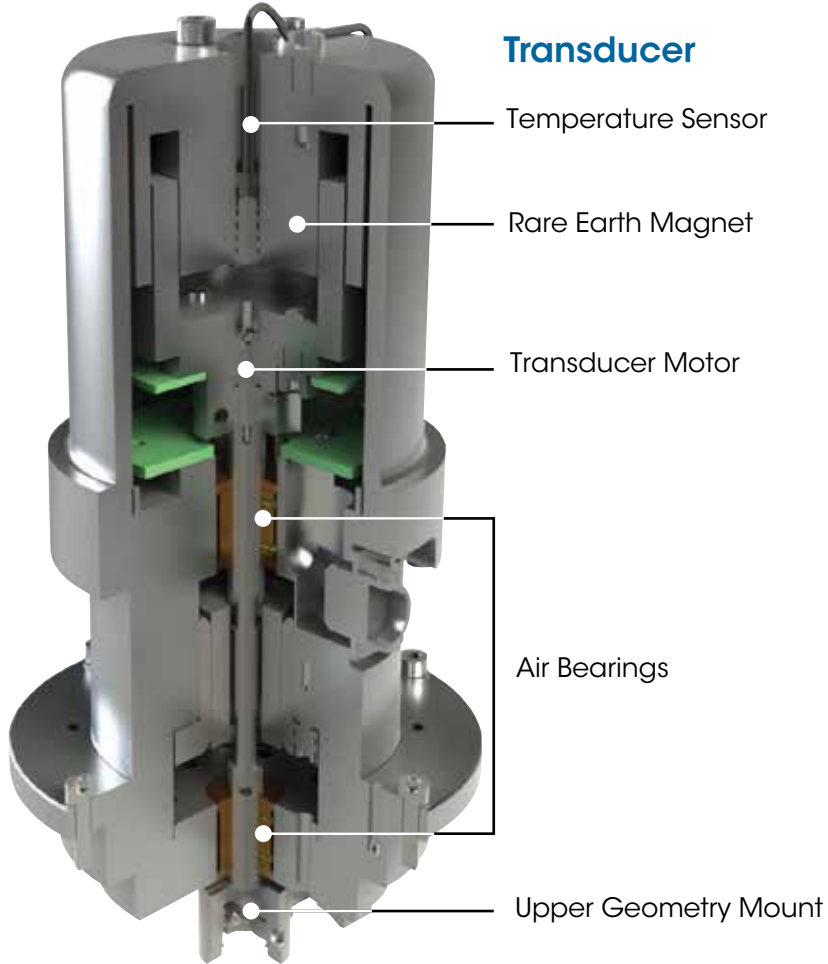
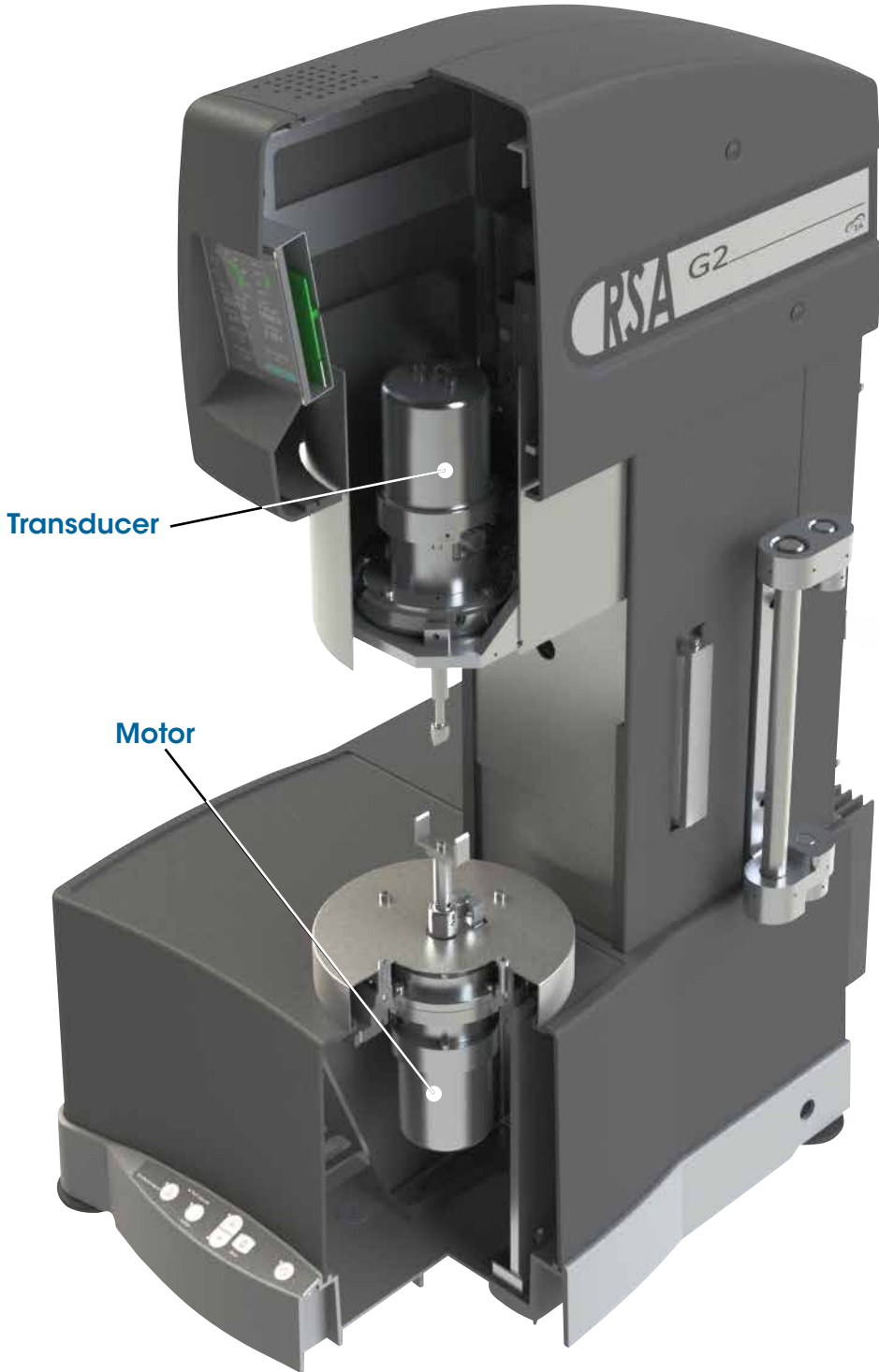

RSA-G2 Design Advantage

The RSA-G2 transducer is mounted to the instrument frame by a linear slide and stepper motor allowing for independent vertical positioning. Transducer motion is via a precision ground lead screw attached to a micro-stepping motor by a rigid preloaded duplex bearing eliminating backlash. A linear optical encoder is mounted directly between the stationary frame and moving bracket for precision head positioning to an accuracy of 0.1 μm .

Benefits of the independent transducer positioning are:

- Ease of clamp installation and sample loading
- Compensation of sample expansion/contraction during experiments
- Additional testing capabilities to large deformations such as strain rate tests to pull samples until failure



High-Speed Electronics and Data Processing

The RSA-G2 is equipped with new high-speed electronics with digital signal processing for transducer measurements and motor control. While many manufacturers cut costs by combining the test station and electronics into a single box, the separate electronics approach of TA Instruments RSA-G2 isolates the precision measurements from heat and vibration. This approach ensures the best sensitivity and data quality from the test station. The electronics enable fully integrated high-speed data acquisition for transient (up to 87 000 Hz) and oscillation (up to 15 000 Hz) measurements. The high sampling speed provides superior resolution of magnitude and phase of the measured signals, and allows much better higher harmonic resolution for automatic analysis during oscillation tests or post Fourier transformation analysis. Higher odd harmonics that occur in the stress (force) signal in oscillation tests are a result of non-linear response. The ratio of the fundamental frequency to odd harmonics, such as 3rd, 5th, etc. can be calculated and stored as a signal. In addition, the real-time waveforms during oscillation tests can be displayed and saved with data points. The intensity ratio and quality and shape of the waveform are invaluable data integrity and validation tools.

Touch-Screen and Keypad

This graphical interface adds a new dimension in ease-of-use. Interactive activities such as clamp zeroing, sample loading, and setting temperature can be performed at the test station. Important instrument status and test information such as temperature, gap, force and motor position are displayed. The touch-screen also provides easy access to instrument settings and diagnostic reporting. The keypad at the base of the instrument allows for easy positioning of the measurement head.



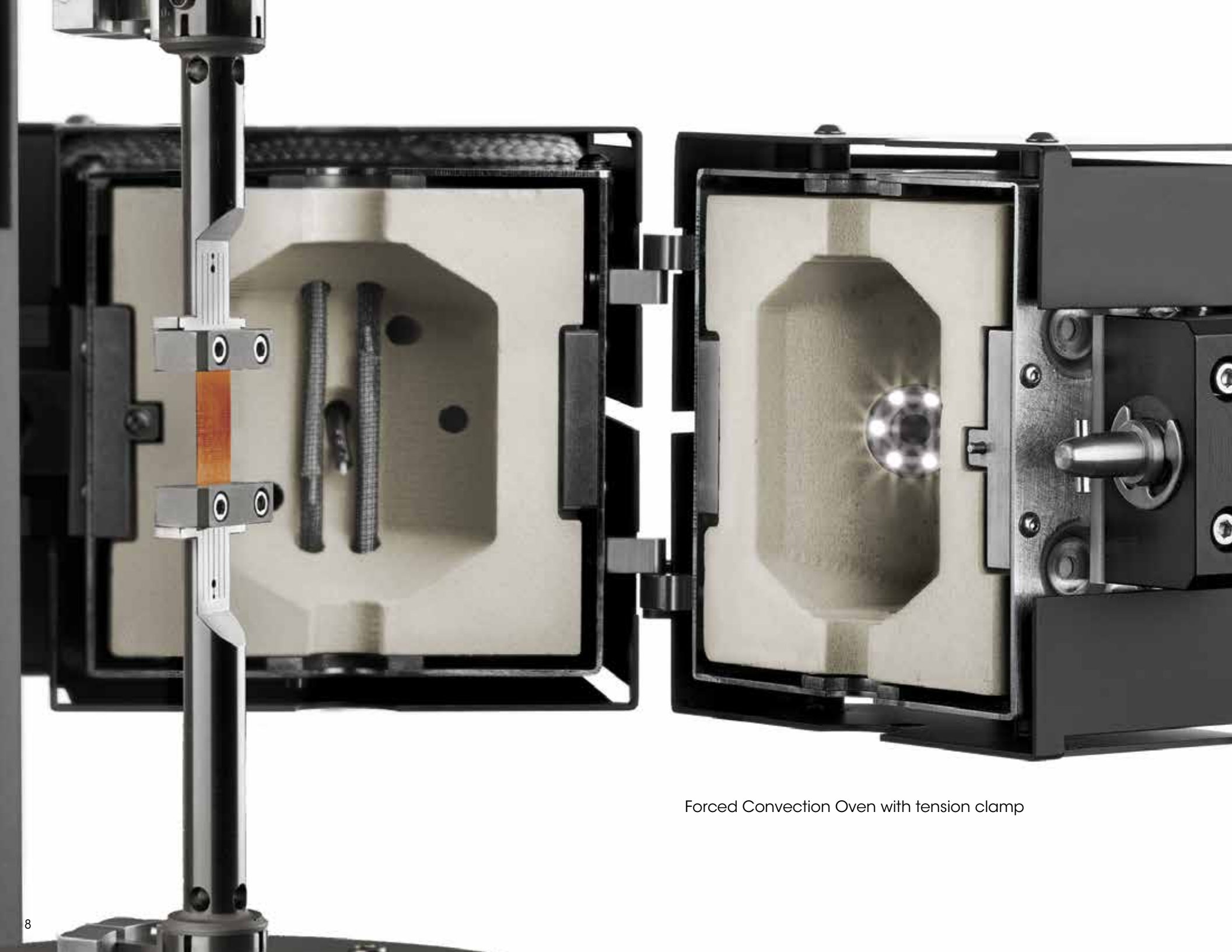

Forced Convection Oven with tension clamp

Forced Convection Oven (FCO)

The FCO is the premier temperature device for mechanical analysis of solids, featuring the fastest temperature response, extreme oxygen exclusion and unrivaled thermal uniformity. This gas-convection oven is designed for optimum temperature stability, extremely rapid heating and cooling, and ease-of-use over the temperature range of -150 °C to 600 °C. This powerful heating mechanism can heat at controlled rates up to 60 °C/min. An available liquid nitrogen cooling system is employed to achieve rapid, uniform and efficient cooling to temperatures as low as -150 °C. Alternatively, mechanical chiller systems can also be used to cool as low as -100 °C without the need for liquid nitrogen. The FCO provides exceptional exclusion of oxygen, making it an effective option for high temperature testing of polymers with poor oxidative stability. Superior temperature stability and uniformity is achieved through the use of twin element heaters, which produce counter-rotating airflow in the oven chamber to heat the sample quickly and without thermal gradients.

The FCO can be mounted on either side of the test station and comes standard with a long-life internal LED lamp and window viewing port. An optional camera viewer can be used to record real-time sample images throughout experiments. This visual record is helpful for data validation and sample condition verification.

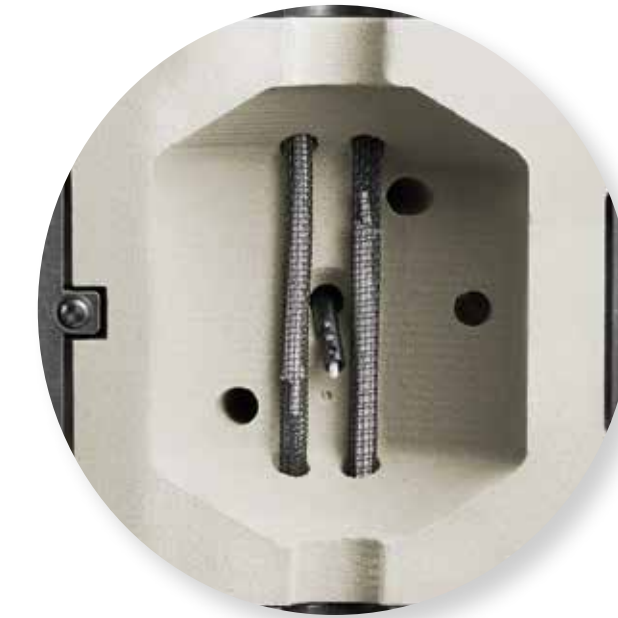

The Forced Convection Oven is designed to **optimize temperature response time, uniformity and stability**. Gas is passed over two resistive gun heaters and into the specially-shaped oven cavity which optimizes gas mixing and uniformity. Up to five thermocouples within the oven make continuous measurements of temperature and are used to determine what power and gas flow should be commanded to each heating gun to maintain the ideal thermal environment.

FCO Camera Viewer

The FCO can be fitted with an optional camera viewer accessory. The camera includes additional lighting and focus controls which can be adjusted through the TRIOS control software. During the experiment real-time images are displayed in the software and images can be stored with data points for subsequent viewing.



RSA-G2 | CLAMPING SYSTEMS

RSA-G2 Clamping Systems

The RSA-G2 features a variety of sample clamps that provide multiple modes of deformation to accommodate a wide range of sample stiffness. The RSA-G2 can easily characterize films, fibers, soft foams, pressure sensitive adhesives (PSA), thermoplastic or thermoset bar samples, high modulus composites, metals, and even medium to high viscosity polymer melts in shear sandwich. All sample clamps are constructed from 17-4 PH steel for maximum rigidity. Standard sample clamps are for use to a maximum temperature of 500 °C. Optional stainless steel sample clamps required for testing to 600 °C are available upon request.

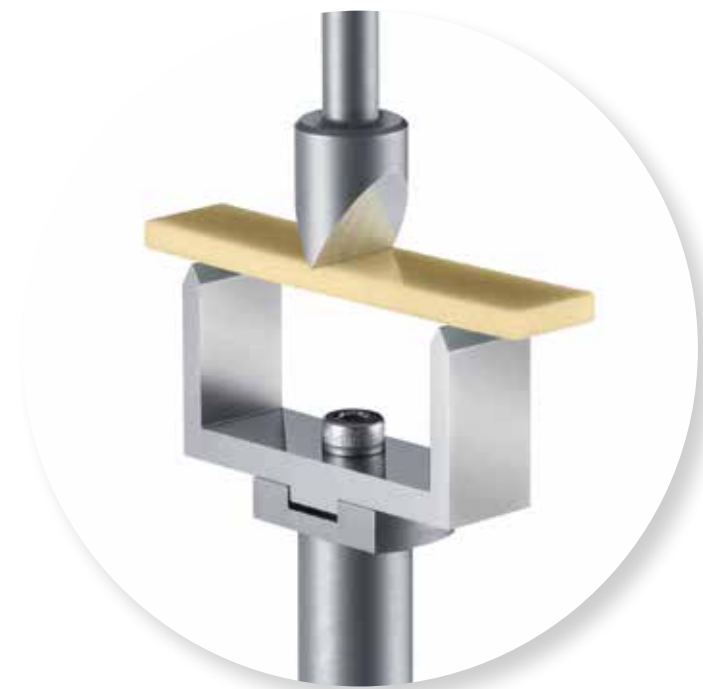

Three-point Bending

In this mode, the sample is deformed around three-point contacts at both ends and its middle. It is considered a "pure" mode of deformation as the sample is freely supported by fulcrums eliminating clamping effects. It is ideal for testing solid bars of stiff materials, such as composites, ceramics, glassy and semi-crystalline polymers, and metals. The clamp comes standard with every RSA-G2 for routine instrument calibration.

Sample Size: includes interchangeable span pieces for sample lengths of 10, 25, and 40 mm. Maximum sample width is 12.8 mm and maximum thickness is 5 mm.



Tension

In this mode, the sample is clamped at the top and bottom and placed in tension. The tension clamp is for tensile testing of thin films, such as garbage bags, packaging films, and individual fibers and fiber bundles.

Sample Size: Up to 35 mm long, 12.5 mm wide, and 1.5 mm thick.



Dual and Single Cantilever

Cantilever modes are also known as "clamped" or "supported" bending modes because the support and deformation points are mechanically fixed to the sample. In dual cantilever the sample is clamped at both ends and at the center. The same clamp is used for single cantilever and the sample is clamped between one end and the central clamp. Single cantilever allows for testing of shorter sample lengths. Cantilever is ideal for general-purpose testing of thermoplastics and elastomers and other highly damped materials, as well as measuring transitions of coatings on substrates.

Sample Size: Up to 38 mm long, 12.5 mm wide, and 1.5 mm thick.



Shear Sandwich

In Shear Sandwich, two equal-size pieces of a material are "sandwiched" between two ends and a central plate. The applied deformation is parallel to the sample thickness and the resultant deformation is simple shear. Typical samples tested include polymer melts, foams, elastomers, gels, pastes, and other soft solids or high viscosity liquids.

Sample Size: Includes three interchangeable central shearing plates to accommodate sample thicknesses of 0.5, 1.0 and 1.5 mm; shearing surface is 15 mm square.



Compression

In this mode, the sample is placed between upper and lower round plates and deformed under various conditions of compression. Compression can be used for testing of many low to moderate modulus materials including foams, elastomers, gels, and other soft solids.

Sample Size: includes three interchangeable sets of plates 8, 15, and 25 mm in diameter; maximum sample thickness is 15 mm.



Contact Lens Fixture

The Contact Lens Fixture was designed for testing the dynamic mechanical properties of contact lenses submerged in saline solution over a specific temperature range.

IMMERSION TESTING | CLAMPING SYSTEMS

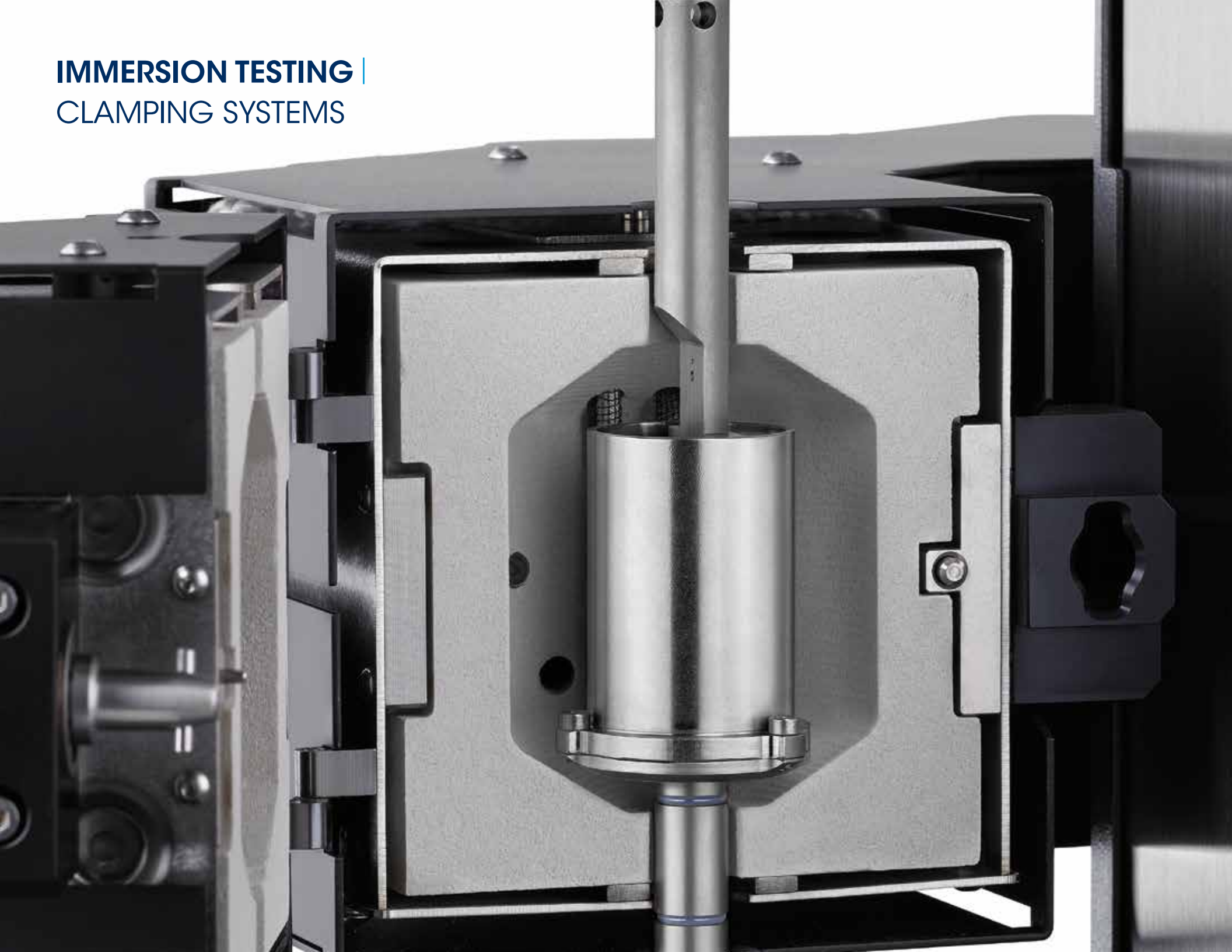

The RSA-G2 Immersion System was designed for mechanical testing of solid materials while immersed in a liquid. The temperature of the fluid environment is measured by a platinum resistance thermometer, PRT, immersed in the liquid, which bypasses the standard control loop of the forced convection oven. Obtainable temperature range is -10 to 200 °C. The system includes tension, compression, and three-point bending geometries. The cup surrounding the sample is removable for easy sample loading.

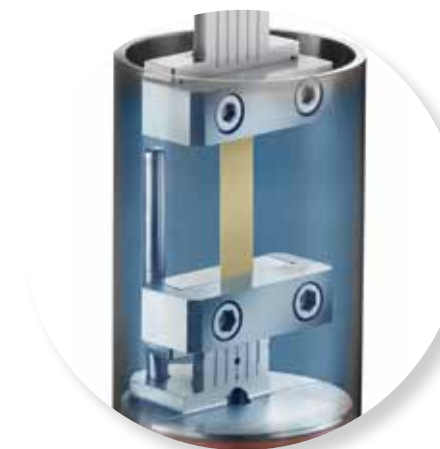

Tension

Up to 25 mm long, 12.5 mm wide and 1.5 mm thick.

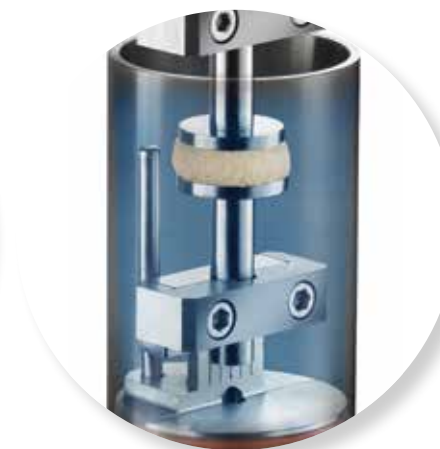

Compression

15 mm plate diameter; maximum sample thickness is 10 mm.



Three-Point Bend

Includes interchangeable span pieces to accommodate sample lengths of 10, 15, and 20 mm. Maximum sample width is 12.5 mm and maximum thickness is 5 mm.

RSA-G2 Immersion Application

The left figure shows the storage modulus, loss modulus, and $\tan \delta$ for temperature ramp tests run on an automotive coating tested in air and immersed in a solvent. The solvent has a dramatic effect on the mechanical properties of the coating. The water has a plasticizing effect on the material. The glass transition temperature is observed to decrease by almost 29 °C from 102 °C to 73 °C.

The figure on the right shows a series of frequency sweeps run on an Elastomer sample immersed in synthetic oil at a temperature of 25 °C for three days. The frequency sweep was run on the sample as soon as immersed on day one, and repeated on days two and three. The storage modulus E' showed a 16% decrease in magnitude over the three days.

Effect of Solvent on Automotive Coating

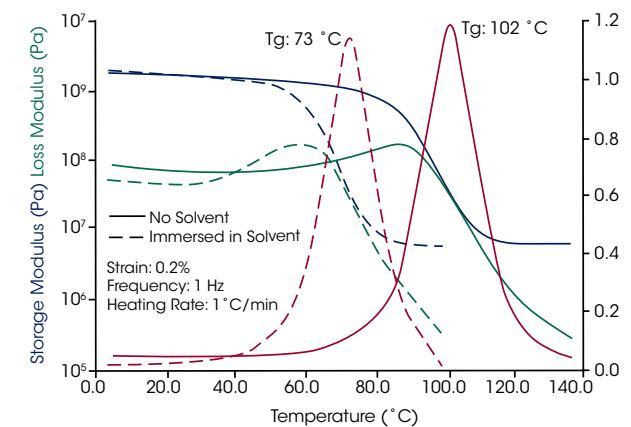

Elastomer Immersed in Synthetic Oil

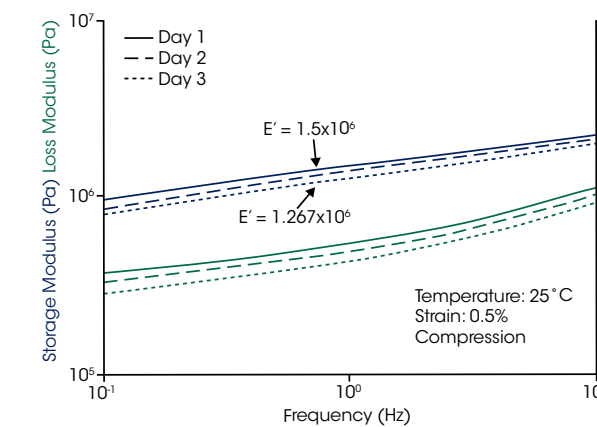

DETA | DIELECTRIC THERMAL ANALYSIS ACCESSORY, DETA

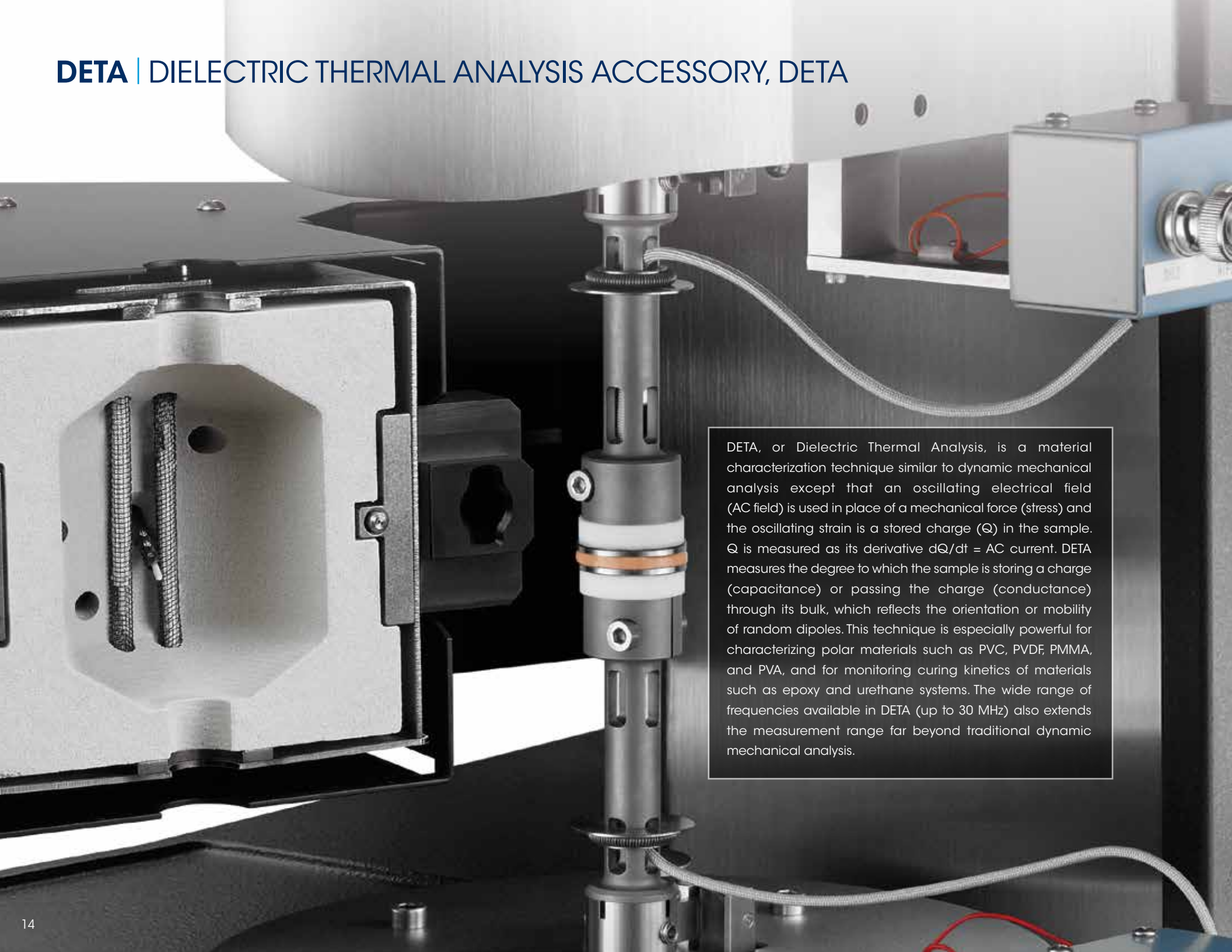

DETA, or Dielectric Thermal Analysis, is a material characterization technique similar to dynamic mechanical analysis except that an oscillating electrical field (AC field) is used in place of a mechanical force (stress) and the oscillating strain is a stored charge (Q) in the sample. Q is measured as its derivative $dQ/dt = AC$ current. DETA measures the degree to which the sample is storing a charge (capacitance) or passing the charge (conductance) through its bulk, which reflects the orientation or mobility of random dipoles. This technique is especially powerful for characterizing polar materials such as PVC, PVDF, PMMA, and PVA, and for monitoring curing kinetics of materials such as epoxy and urethane systems. The wide range of frequencies available in DETA (up to 30 MHz) also extends the measurement range far beyond traditional dynamic mechanical analysis.

Dielectric Thermal Analysis

The combination of DETA with a high precision RSA-G2 solids analyzer allows for the simultaneous collection of rheological and dielectric information. A special set of parallel plates is connected directly to a dielectric bridge (LCR meter) which imposes a signal at a certain voltage and frequency/ies. The RSA-G2 also enhances stand-alone dielectric measurements by improving sample conditions. DETA measurements are conducted on a material sandwiched between parallel plates, with force applied to ensure good surface contact, and surrounded by an oven for temperature control. In competitive instruments, the permittivity, or dielectric constant, is measured by the ratio of capacitance with the sample in the plates to the capacitance with the same air gap. As temperature changes and expansion of the plates occurs, the gap changes and the accuracy of the permittivity suffers. The RSA-G2 FCO (forced convection oven) temperature control, axial force control with gap temperature compensation capability, and software for interface, results in more accurate DETA measurements.

RSA-G2 DETA SPECIFICATIONS

Geometry	25 mm Parallel Plates
Temperature System	FCO, Forced Convection Oven
Temperature Range	-150 °C to 350 °C
RSA-G2 to DE Bridge Interface	IEEE Internal to Instrument
Available Dielectric Bridges	Keysight Model E4980AL; 20 Hz to 1 MHz; 0.001 to 2 Volts
	Keysight Model E4980A; 20 Hz to 2 MHz; 0.005 to 20 V

DETA Experiments

The RSA-G2 DETA accessory can easily be programmed to run a variety of standard experiments through TRIOS Software. Experiments include dielectric frequency sweeps at isothermal temperature, isothermal time sweep tests at one or more dielectric frequencies, temperature ramp tests at one or more dielectric frequencies, and temperature step and hold profiles with single or multiple dielectric frequencies.

Dielectric Frequency Sweep on Rubber

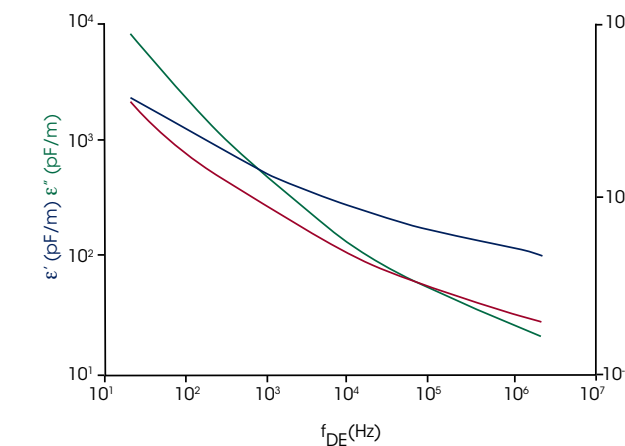

Frequency Sweep

The above figure shows an example of a dielectric frequency sweep run on a rubber sample under ambient conditions. Shown are the storage and loss permittivity and loss tangent over a frequency range of 20 Hz to 2 MHz.

DETA Temperature Ramp on PMMA

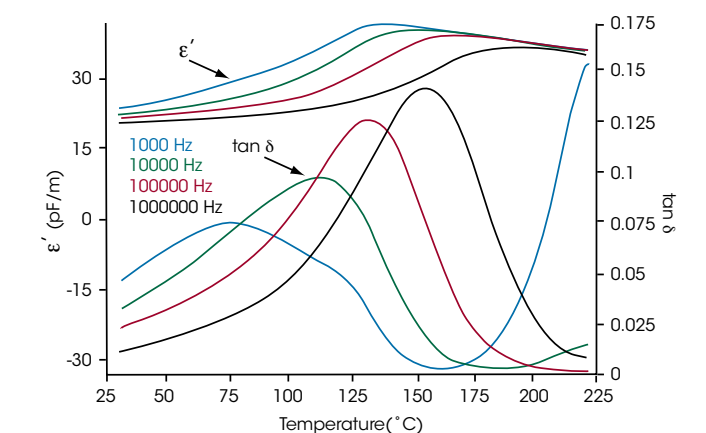

Temperature Ramp

Here is an example of a ramp on a PMMA Sample at four different Dielectric Frequencies ranging from 1kHz to 1MHz. It can be seen here that the magnitude of ϵ' decreases with increasing frequency through the transition region and the peak of the transition in $\tan \delta$ moves to higher temperatures with increasing frequency.

DYNAMIC MECHANICAL ANALYSIS | TESTING MODES & APPLICATIONS

Dynamic Mechanical Analysis, DMA

DMA is the most common test type for measuring viscoelastic properties of materials. Both elastic and viscous characteristics of the material can be studied by imposing a sinusoidal strain (or stress) and measuring the resultant sinusoidal stress (or strain) along with the phase difference between the two sinusoidal waves (input and output). The phase angle is zero degrees for purely elastic materials and 90° for purely viscous materials. Viscoelastic materials exhibit a phase angle anywhere between these two ideal cases depending on the rate of deformation. The figures below show these sinusoidal responses along with the variety of rheological parameters obtained. The viscoelastic parameters can be measured as a function of deformation amplitude, frequency, time, and temperature and examples of each important experiment are provided.

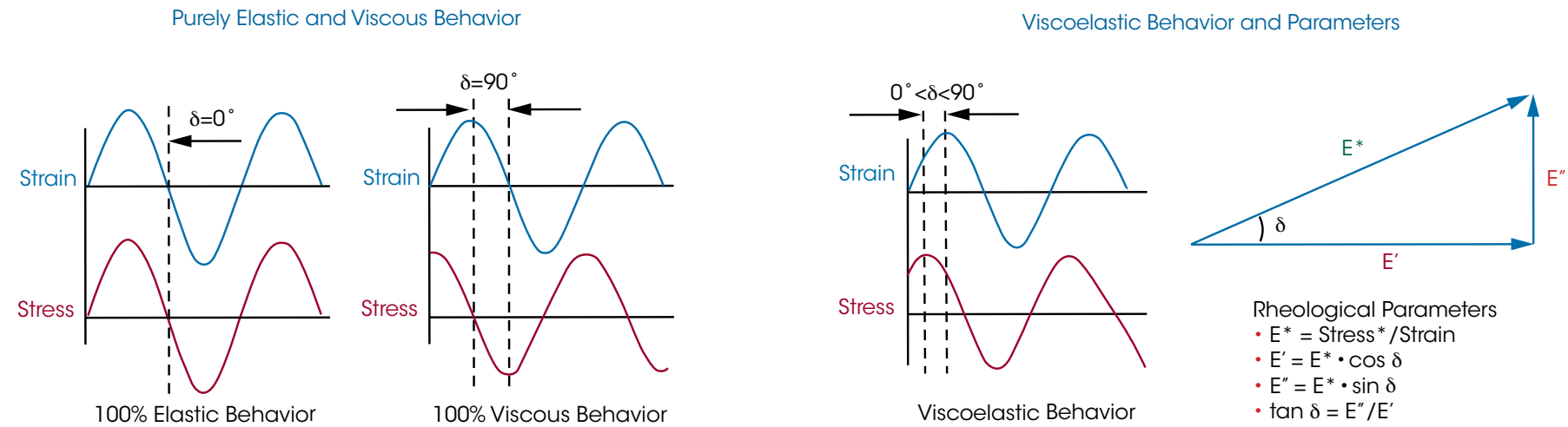

Strain Sweep

In this test, the frequency and temperature are held constant and the strain is varied. Strain Sweep tests are used to identify the linear viscoelastic region, LVR. Testing within the LVR provides powerful structure-property relationships as a material's molecular arrangements are never far from equilibrium and the response is a reflection of internal dynamic processes. The right figure shows a strain sweep on a filled elastomer sample tested at 10 Hz in dual cantilever bending geometry. At low strains, within the LVR, the modulus is independent of the strain amplitude. At about 0.1% strain the modulus begins to decrease in magnitude showing the end of the LVR. Outside the LVR the output stress response to the input strain is no longer sinusoidal. Non-linear effects show up as higher odd harmonics which the RSA-G2 is able to collect. The figure shows the intensity ratio of the third to first harmonics at each strain value. Strain sweep tests can be used for a variety of additional reasons such as understanding the Mullins Effect in a rubber or comparing the resiliency of materials.

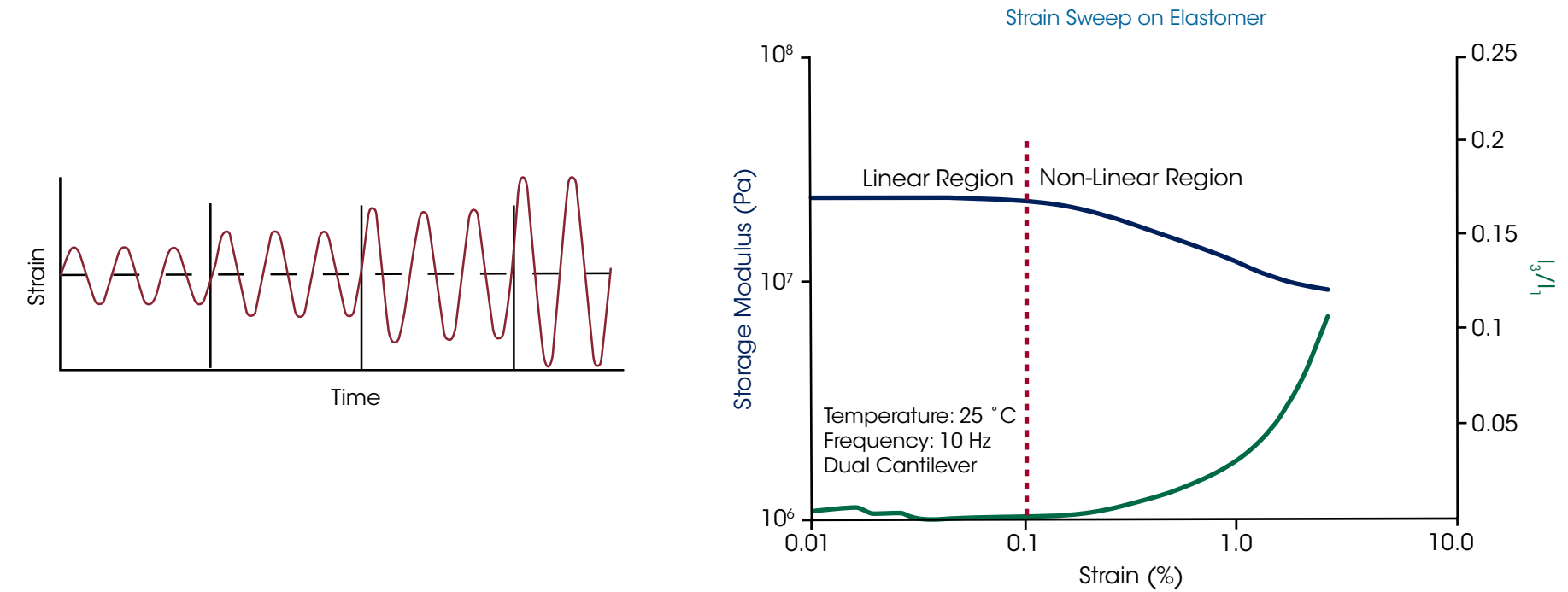

DYNAMIC MECHANICAL ANALYSIS | TESTING MODES & APPLICATIONS

Temperature Ramps

These are the most common DMA experiments. Measuring the viscoelastic properties over a range of temperatures is an extremely sensitive technique for obtaining the α or glass transition temperature, T_g , as well as any additional β or γ transitions in a material. In a temperature ramp, a linear heating rate is applied. Typical heating rates are on the order of 1 to 5 °C/min. The material response is monitored at one or multiple frequencies at an amplitude within the LVR with data taken at defined time intervals.

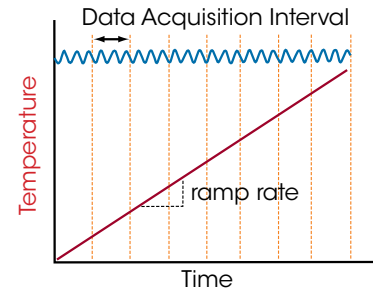

The figure below shows a temperature ramp on Polycarbonate run in single cantilever. Note the data start in the glassy region and are measured into the melt demonstrating the advantage of the RSA-G2 technology. Multiple parameters can be used to determine transitions including E' onset point or peaks in the E'' or $\tan \delta$. The temperature at which the transition occurs depends on the parameter selected.

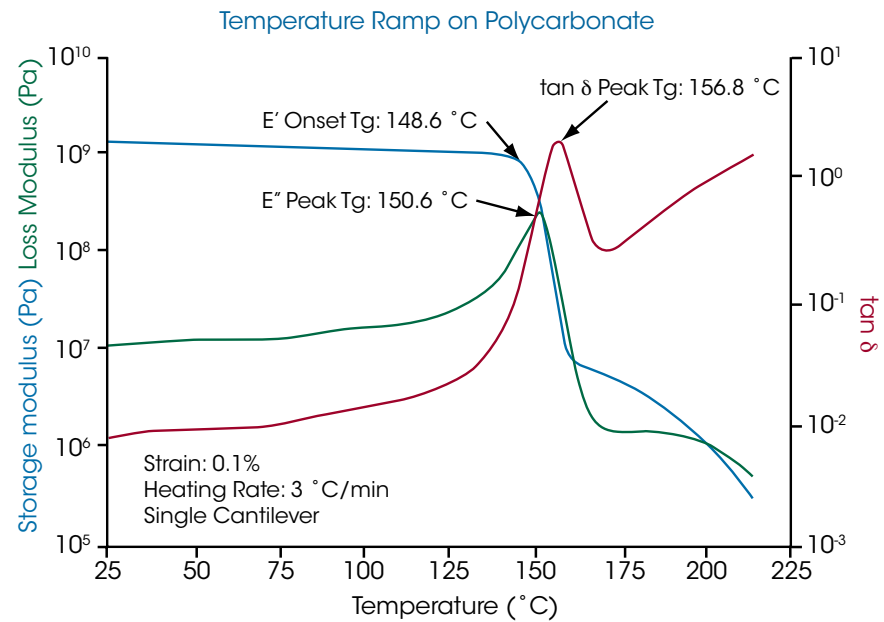

Because the T_g has a kinetic component, it is strongly influenced by the frequency (rate) of deformation. As the frequency increases, the molecular relaxations can only occur at higher temperatures and, as a consequence, the T_g will shift to a higher temperature. An example of the frequency dependence of a glass transition is shown below for a sample of Polyphenyl Sulfide. Note the shape and intensity of the $\tan \delta$ peak and the slope of the storage modulus in the transition region will be affected.

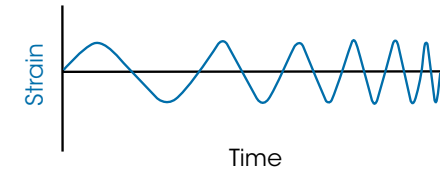
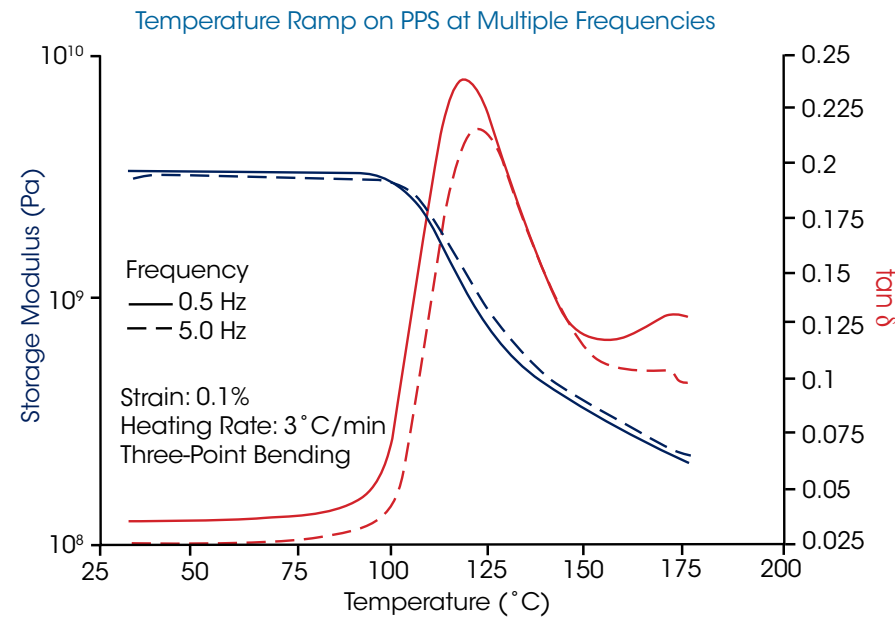

Frequency Sweep

In this test, the temperature and strain are held constant and the frequency is varied. The left figure illustrates a viscoelastic fingerprint for a linear homopolymer and shows the variation of E' and E'' as a function of frequency. As frequency is the inverse of time, the curve shows the time-dependent mechanical response, with short times corresponding to solid-like behavior and long times to liquid-like behavior. The magnitude and shape of the E' (G') and E'' (G'') curves depend on the molecular structure. Frequency sweeps are typically run over a limited range of 0.1 to 100 Hz as shown below on the right for a pressure sensitive adhesive at 70 °C using the RSA-G2 shear sandwich clamp. At this temperature and frequency range, the sample is in the terminal and plateau regions.

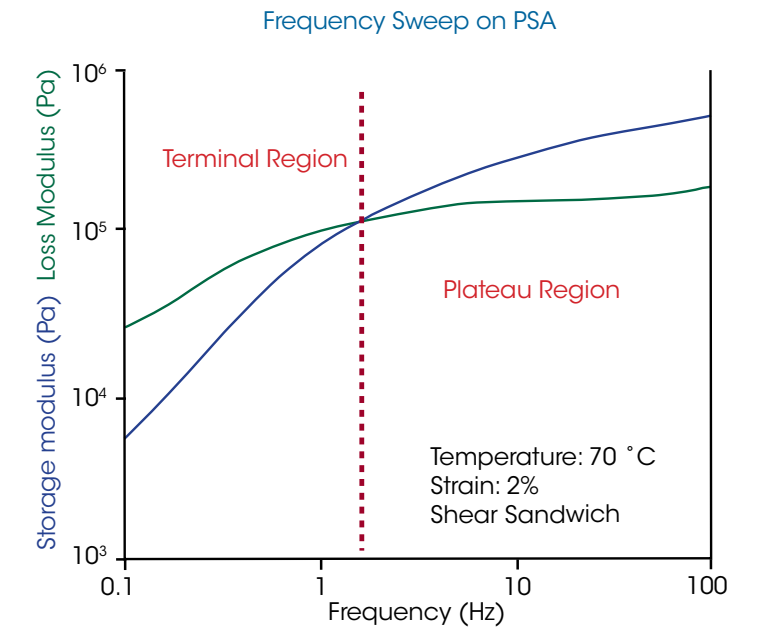
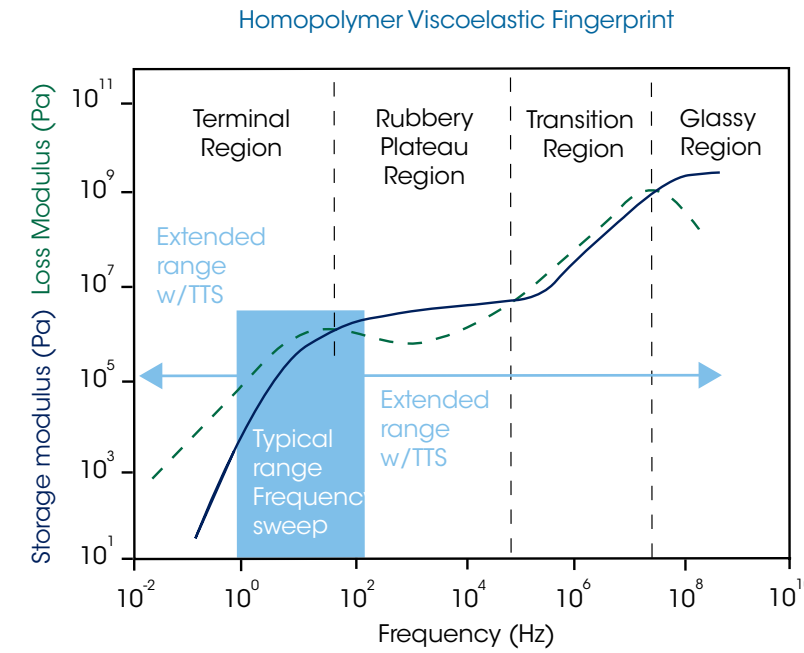

DYNAMIC MECHANICAL ANALYSIS | TESTING MODES & APPLICATIONS

Temperature Sweeps

In this test, a step and hold temperature profile is applied. At each temperature step, the sample is held at temperature for a defined amount of time to ensure temperature uniformity in the material. The material response is then measured at one or multiple frequencies at a strain within the LVR.

The top figure shows results of a temperature sweep on a pressure sensitive adhesive over a temperature range of 40 °C to 80 °C. At each 10 °C step in the sweep, the sample was scanned over a frequency range of 0.1 to 100 Hz. The storage modulus is plotted as a function of frequency for each 10 °C step. This is the method of choice for Time-Temperature Superposition studies as all the frequency-dependent data are collected at the same temperature.

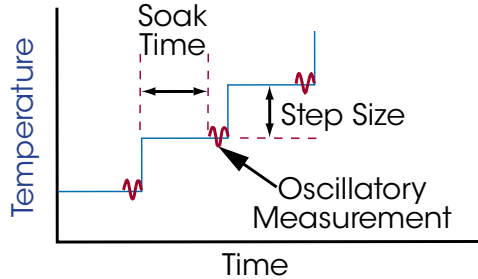

Time-temperature superposition (TTS) is used to extend the frequency range by running a series of frequency sweeps over a wide range of temperatures. The bottom figure shows a master curve constructed at a reference temperature of 25 °C for a sample of Acrylonitrile-butadiene-styrene (ABS). In this example the original frequency range of two decades was extended to 14 decades.

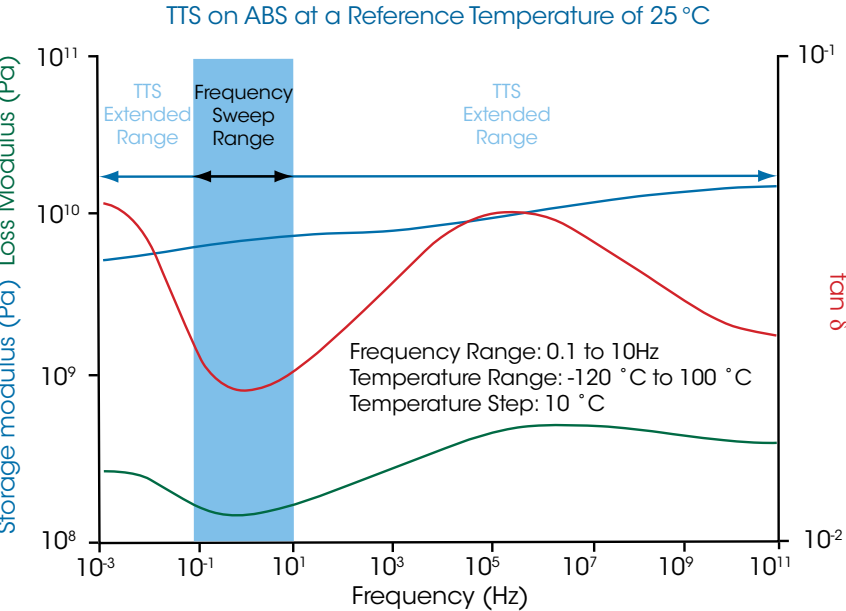
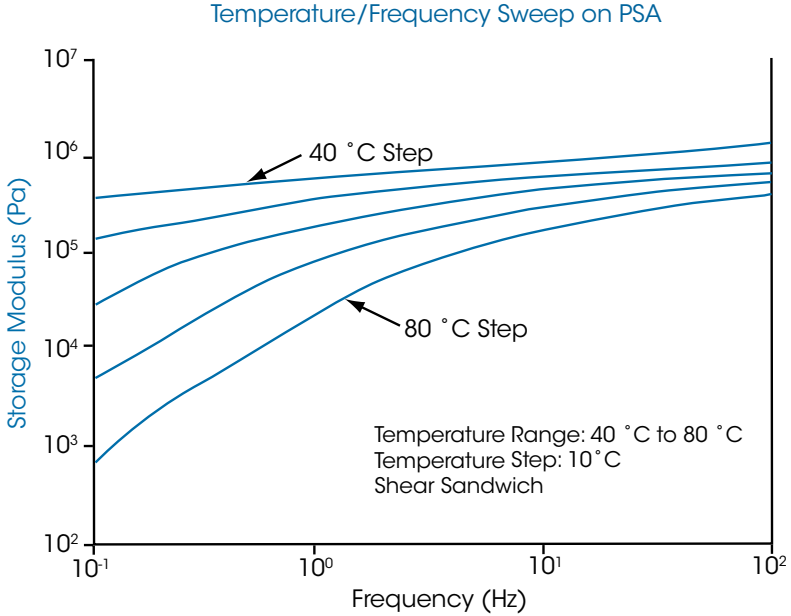

Time Sweep

In this test, the temperature, strain, and frequency are all held constant while the viscoelastic properties are measured as a function of time. Time sweep provides important information on time-dependent structural changes such as a curing reaction or fatigue studies. The right figure shows an example of a two-part epoxy cured on a supporting fiberglass braid using a dual cantilever clamp. At short times the storage modulus is low and increases in magnitude as the epoxy cures and hardens.

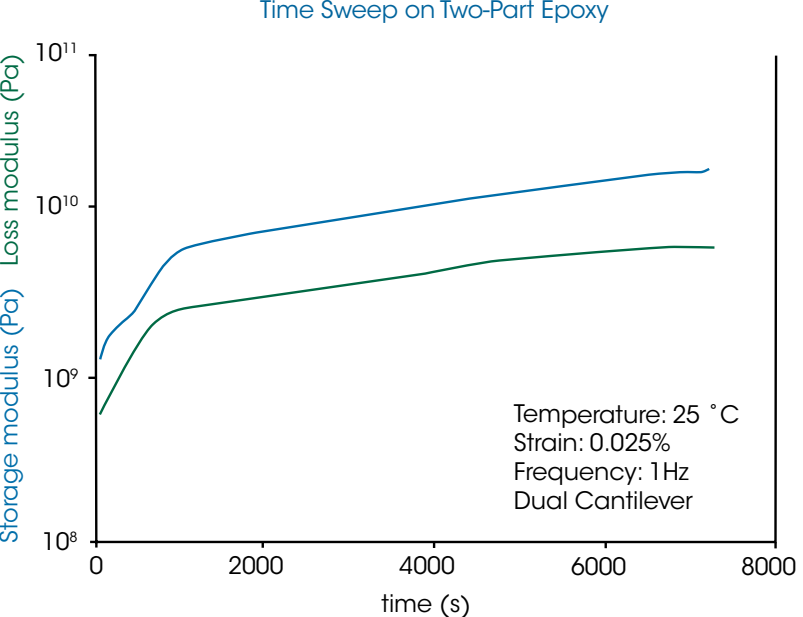
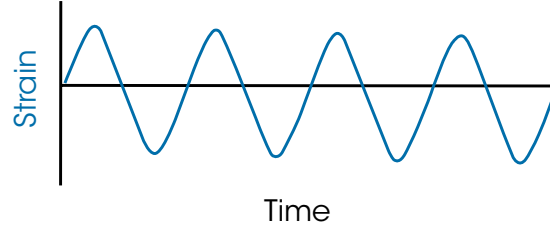

DYNAMIC MECHANICAL ANALYSIS | TESTING MODES & APPLICATIONS

Step Tests: Creep and Stress Relaxation

Step Tests, including Stress Relaxation and Creep Recovery, are so-named because the sample deformation or stress is applied in a step fashion. Both are highly sensitive tests for measuring viscoelastic properties of materials. In creep and recovery, a constant stress is applied to the sample at t_1 and the resulting strain is measured over time. At t_2 the stress is removed and the recovery (recoil) strain is measured. The creep compliance, $D(t)$, is calculated from the stress and time-dependent strain. In stress relaxation, an instantaneous strain is applied to the sample and held constant. The resulting stress decay is measured as a function of time yielding relaxation modulus $E(t)$ or $G(t)$.

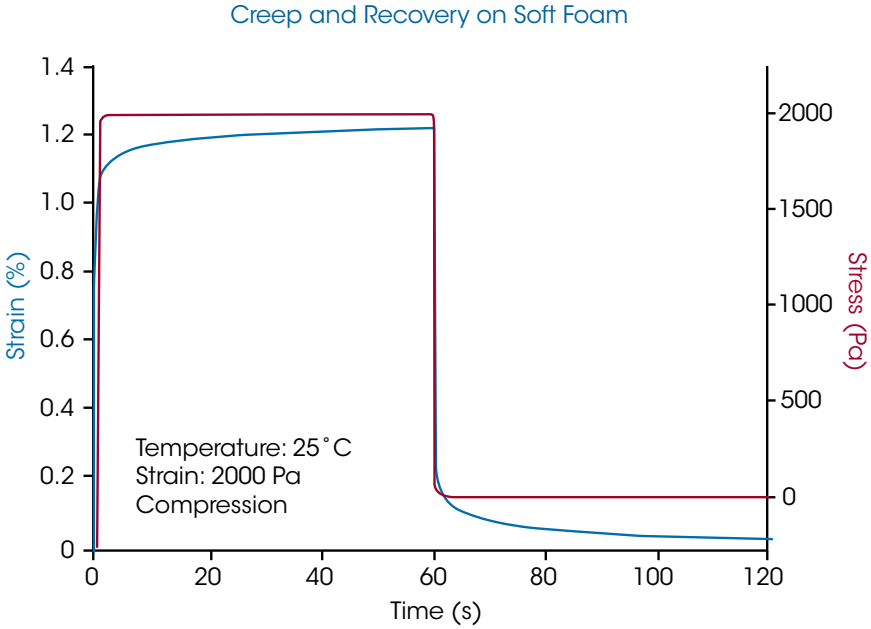
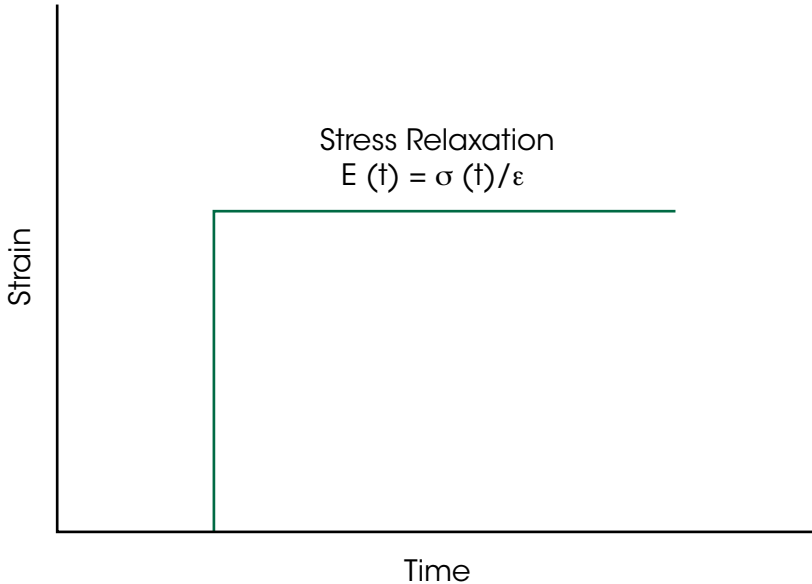
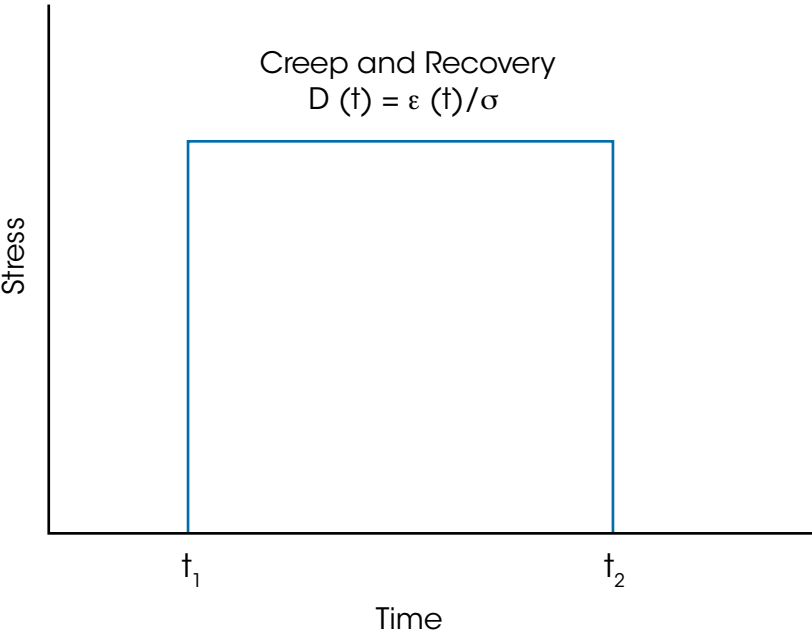

Here is an example of creep and recovery for a soft foam material in compression. A stress of 2,000 Pa was applied for 60 s and strain recovery was monitored for 60 s.

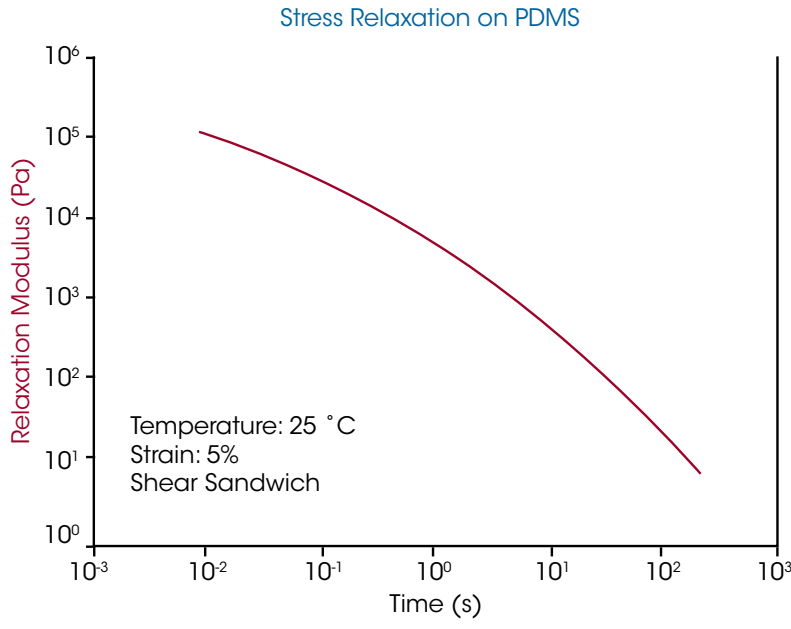

This figure shows the stress relaxation modulus for PDMS in a shear sandwich clamp at 25 °C and 5% strain. $G(t)$ is calculated from the time-dependent stress decay divided by the applied strain and provides a quick and easy way to directly measure relaxation times in materials.

DYNAMIC MECHANICAL ANALYSIS | TESTING MODES & APPLICATIONS

Iso-strain and Iso-stress Tests

In this mode, the strain or stress is held at a constant value and a linear heating rate is applied. These tests are valuable for assessing mechanical behavior under conditions of fixed load (stress) or fixed deformation (strain). The right figure shows a sample of PET film tested in tension geometry under iso-stress conditions with a linear heating rate followed immediately by an iso-strain condition and linear cooling rate. It can be observed in the figure that under iso-stress the strain gets larger as the sample is heated and softens. At a temperature of 85 °C the strain is then held constant and as the sample is cooled, the sample stress gets larger. These test modes are ideal for characterization of shape memory materials.

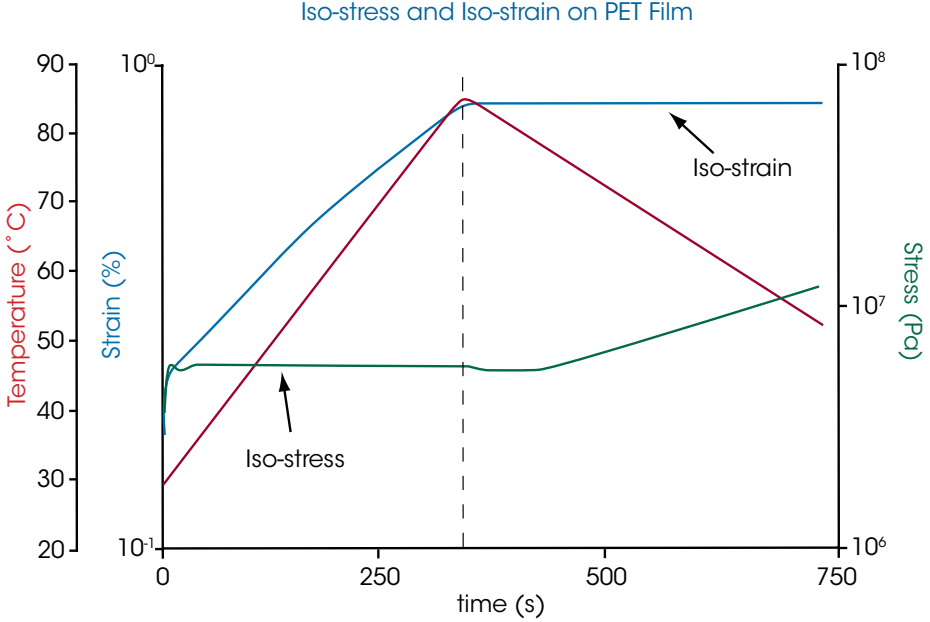
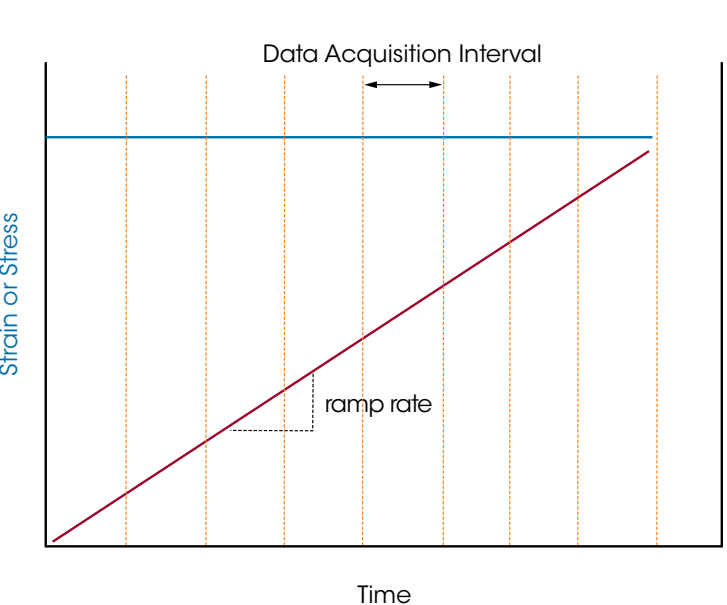

Axial Tests

The linear slide and stepper motor for independent vertical positioning of the instrument's transducer enable the RSA-G2 to conduct additional axial tests for the ultimate testing flexibility. A sample can be deformed under a constant linear strain rate, Hencky strain rate, force, or stress for generating more traditional stress-strain curves.

The below left figure shows a Polyethylene film tested using the tension geometry at 25 °C and a constant linear rate of 5 μm/s. A classical stress-strain curve is observed with yield point, ultimate tensile strength, and fracture point.

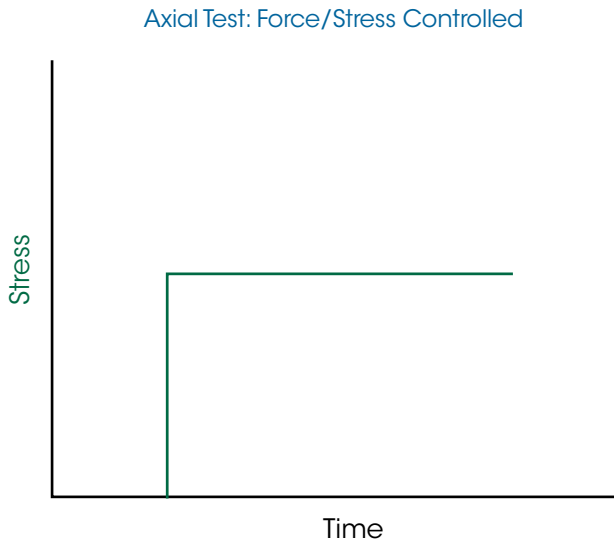
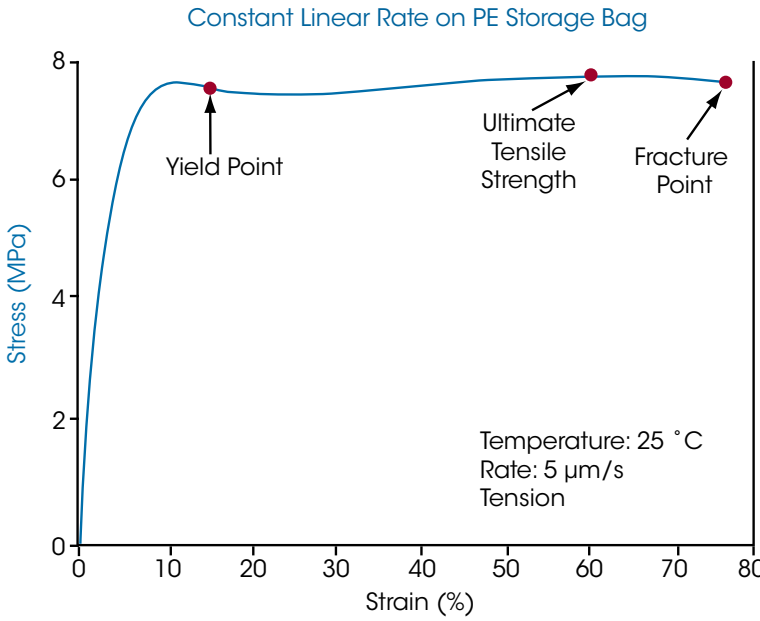
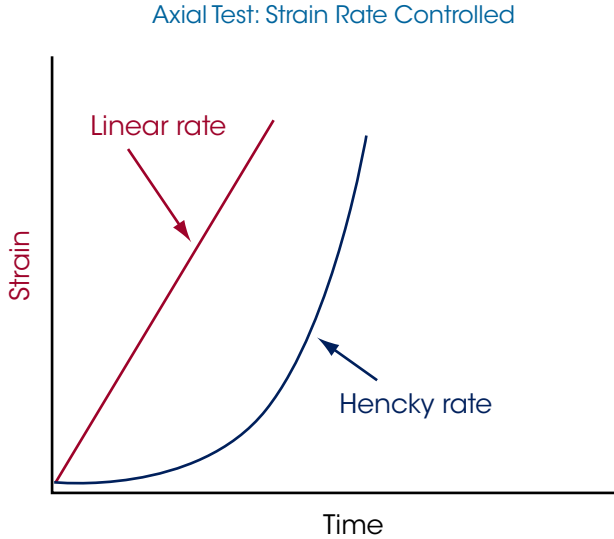



Air Chiller Systems (ACS-2 and ACS-3)

The new Air Chiller Systems are unique gas flow cooling systems that enable temperature control of the Forced Convection Oven without the use of liquid nitrogen. Equipped with multi-stage cascading compressors, the ACS-2 and ACS-3 permit operation of the FCO at temperatures as low as -55 °C and -100 °C, respectively. Utilizing compressed air, the Air Chiller Systems can help eliminate or reduce liquid nitrogen usage from any laboratory and offers an incredible return on investment.

Features and Benefits

- Safe:** Eliminates the need for liquid nitrogen or other refrigerated gases
- Convenient:** Never change, refill, or order another tank of liquid nitrogen.
- Small:** Occupies less space than equivalent liquid nitrogen cooling systems.
- Affordable:** Provides considerable cost savings over recurring gas deliveries.

RSA-G2 SPECIFICATIONS

Minimum Force	0.0005 N
Maximum Force	35 N
Force Resolution	0.00001 N
Dynamic Displacement Range	±0.00005 to ± 1.5 mm
Displacement Resolution	1 Nanometer
Modulus Range	10 ³ to 3 x 10 ¹² P
Modulus Precision	± 1%
Tan δ Sensitivity	0.0001
Tan δ Resolution	0.00001
Frequency Range	2 x 10 ⁵ to 100 Hz
Temperature Control	Forced Convection Oven
Temperature Range	-150 to 600 °C*
Heating Rate	0.1 to 60 °C/min.
Cooling Rate	0.1 to 60 °C/min.
Isothermal Stability	± 0.1 °C



*Note: Standard sample clamps are for use to a maximum temperature of 500°C. Optional sample clamps are required for testing to 600°C.



AMERICAS

- New Castle, DE USA
- Lindon, UT USA
- Wakefield, MA USA
- Eden Prairie, MN USA
- Chicago, IL USA
- Costa Mesa, CA USA
- Montreal, Canada
- Toronto, Canada
- Mexico City, Mexico
- São Paulo, Brazil

EUROPE

- Hüllhorst, Germany
- Bochum, Germany
- Eschborn, Germany
- Wetzlar, Germany
- Elstree, United Kingdom
- Brussels, Belgium
- Etten-Leur, Netherlands
- Paris, France
- Barcelona, Spain
- Milano, Italy
- Warsaw, Poland
- Prague, Czech Republic
- Sollentuna, Sweden
- Copenhagen, Denmark

ASIA & AUSTRALIA

- Shanghai, China
- Beijing, China
- Tokyo, Japan
- Seoul, South Korea
- Taipei, Taiwan
- Guangzhou, China
- Petaling Jaya, Malaysia
- Singapore
- Bangalore, India
- Sydney, Australia



tainstruments.com