

KSV NIMA

Langmuir and Langmuir-Blodgett Deposition Troughs

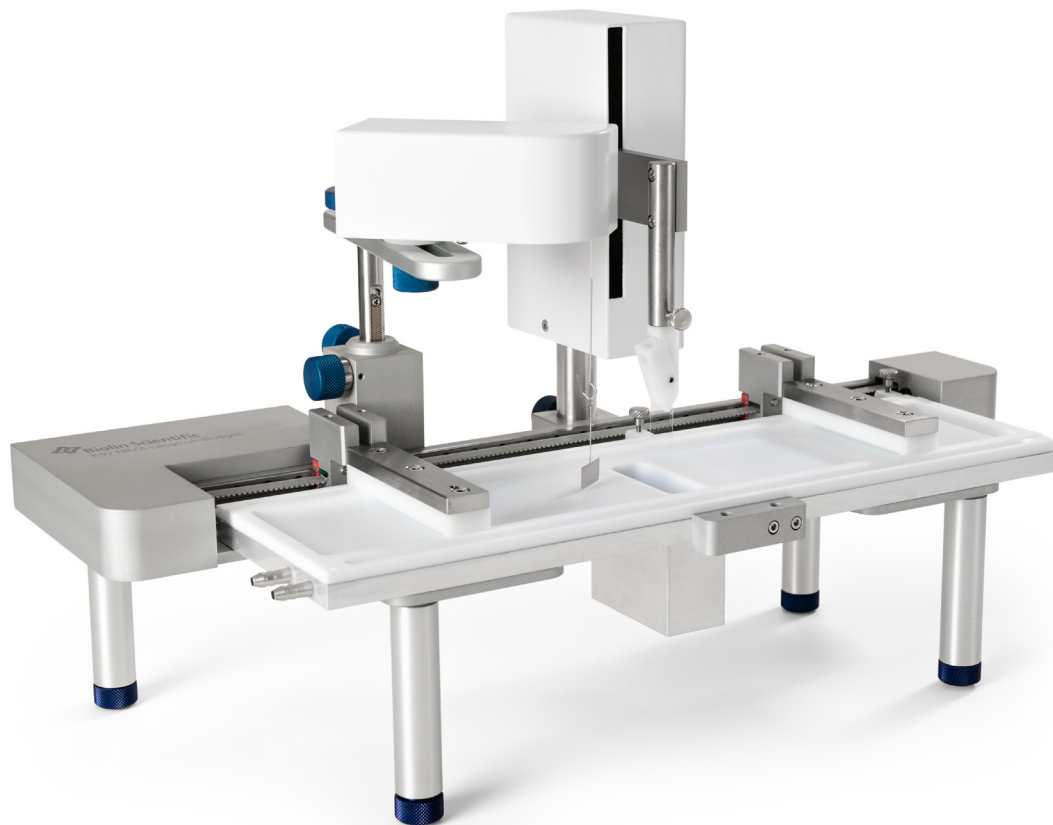

Sophisticated Thin Film Technology

Thin film coatings

Coatings and thin films made from nanoparticles are gaining recognition and use in various products and applications including displays, sensors, medical devices, energy storages and energy harvesting. The challenge to achieve a homogenous coating fulfilling the requirements of optimized packing density, particle organization and film thickness is well-known.

One of the most sophisticated techniques for creating thin films and coatings of nanoparticles are Langmuir-Blodgett (LB) and Langmuir-Schaefer (LS) supplied by KSV NIMA.

Biomembrane modelling

Langmuir technology is a unique method for studying biomembranes. The effect of for example pharmaceuticals or toxins to the biomembrane can be followed real time. Membrane structure and changes in its properties can be characterized further in the presence of proteins or peptides.

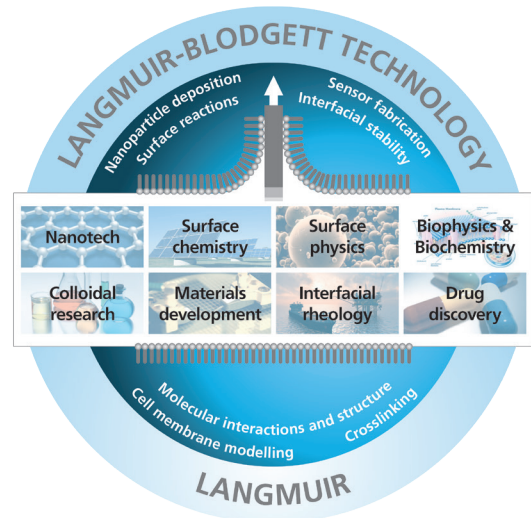

THIN FILM COATINGS WITH CONTROLLED PACKING DENSITY

Application Examples

Controlled nanoparticle and graphene deposition

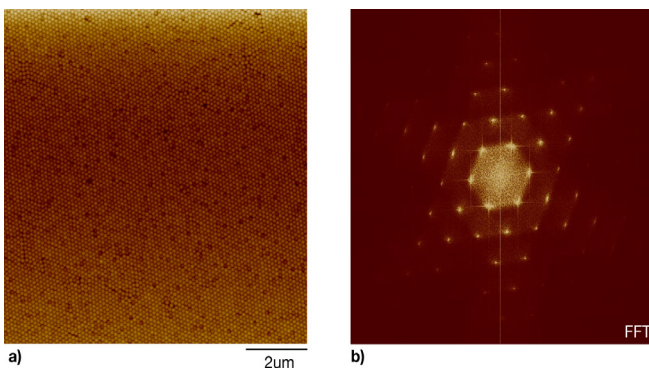

A monolayer of 200nm-diameter polystyrene nanospheres deposited on a quartz substrate using the Langmuir-Blodgett technique on a KSV NIMA Medium trough. (a) AFM image of the monolayer, (b) a Fourier transform of the same image exhibiting the exceptional crystallinity achievable with this technique. Copyright Dr. Alaric Taylor.

Unique tool for biomembrane modelling

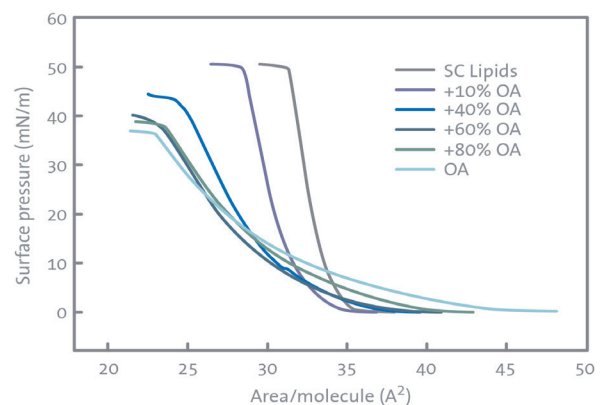

THE ISOTHERMS OF MODEL SKIN LIPIDS WITH INCREASING LEVELS OF OLEIC ACID. With permission from Langmuir 2013, 29 (15), pp 4857–4865. Copyright 2013 American Chemical Society.

How to Create Thin Films

Floating thin films - Langmuir solution

KSV NIMA Langmuir Troughs are used for creating, modifying and studying floating Langmuir films. A Langmuir film can be defined as an insoluble monolayer of functional molecules, nanoparticles, nanowires or microparticles that reside at the gas-liquid or liquid-liquid interface.

The material is deposited on an aqueous subphase in the trough top (3). Barriers (2) compress the monolayer while the pressure sensor (4) monitors the packing density in the monolayer.

As a result, the surface pressure-area isotherm provides information on the interactions between the molecules. The isotherm typically shows a phase of weak intermolecular interactions (gas phase, G), a phase of higher interaction (liquid phase, L) and a phase of high solid dense interaction (solid phase, S).

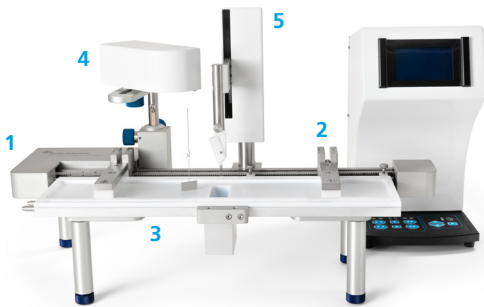

Coated thin films: Langmuir-Blodgett deposition

KSV NIMA Langmuir-Blodgett Deposition Troughs (LB Troughs) have the same capabilities as KSV NIMA Langmuir Troughs as they also enable Langmuir film fabrication and study. As an additional capability, the thin film formed can now be coated on a solid substrate to create a coating of highly organized particles.

An LB trough is equipped with a dipping well and a dipping mechanism (5) that are used for transferring the film with the desired packing density. Typical deposited films include nano-particles, graphene, lipids, polymers, microparticles and various functional organics. The coating can be made vertically (Langmuir-Blodgett) or horizontally (Langmuir-Schaeffer) depending on the configuration.

Nanoscale films of custom thickness can be built up by repeating the deposition.

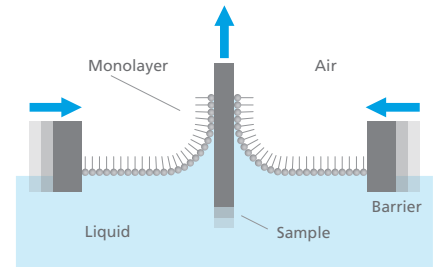
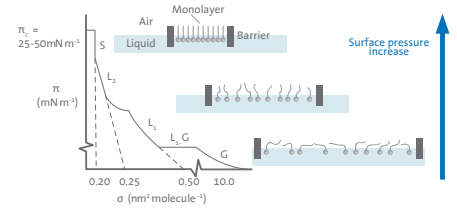

Langmuir-Blodgett deposition

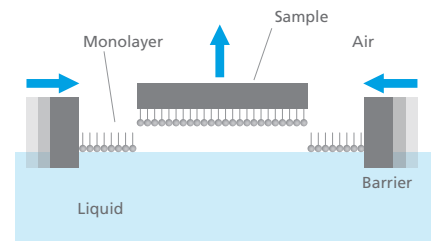

Langmuir-Schaeffer deposition

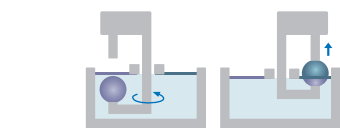
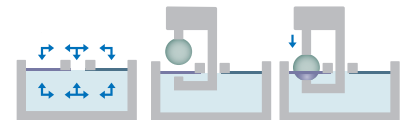

Alternating deposition

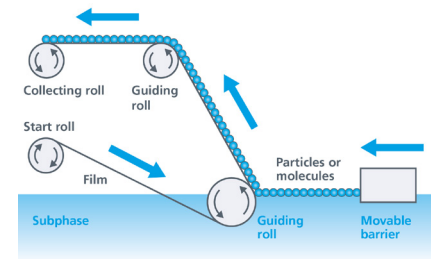

Roll-to-roll deposition

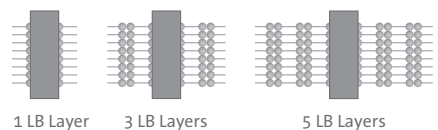

KSV NIMA Langmuir and Langmuir-Blodgett Troughs

KSV NIMA Langmuir and Langmuir-Blodgett Troughs are the ultimate tools for effective thin layer coatings and studies. They combine the knowhow based on over 30 years of experience in working with Langmuir films. The systems have been designed to be extremely versatile and robust to ensure high quality results.

High quality coatings

- Precise control of molecular packing density
- Precise control over coating thickness
- Homogeneous deposition over large areas
- Enables multilayer structures with varying layer composition
- High flexibility to use different kind of particles and substrates
- Coating quality can be pre-monitored prior to deposition

Floating membranes and monolayers

- Monolayer structure and interactions
- Molecular adsorption kinetics
- Phase transitions
- Surface reactions with an injected material
- Interfacial viscoelastic properties

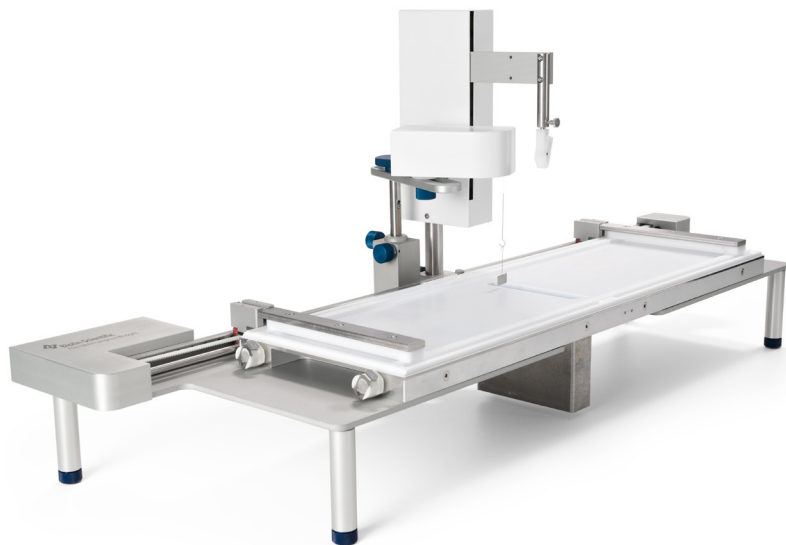

Quality

Single piece solid PTFE trough tops including the dipping well enable easy cleaning without any contaminating glues or coatings. Adjustable legs, trough top locating pins, barrier limit switches and overflow channels ensure safe and reliable use of the system.

Usability

Uses standardized Wilhelmy method with platinum plate for surface pressure sensing with its ultra-sensitive pressure sensor, with the option to use also disposable paper plates to avoid cleaning. Powerful KSV NIMA LB software integrates all controls and data analysis into the same software, including different characterization tools.











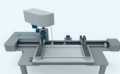
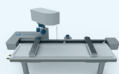

Versatility

Specialized characterization tools enable ensuring floating thin layer quality already prior to coating and after the coating process. Open modular design with simple trough top and barrier placement enables easy integration to characterization systems, upgradeability and easy cleaning of parts.

Troughs For Every Need

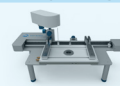
Selection of Langmuir and Langmuir-Blodgett systems

KSV NIMA offers a wide selection of L&LB Troughs with various sizes and functionalities. Our L&LB systems are fully modular, and one frame can be used for different sizes and types of trough top. In addition to the standard offering below, custom trough tops can be created by request. Detailed specifications for each size are available in the specification chart on the last page.

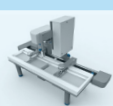
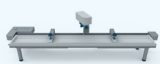
SMALL	MEDIUM	LARGE	HIGH COMPRESSION	ALTERNATE	ROLL-TO-ROLL
Langmuir Troughs					
 KN 1002	 KN 1003	 KN 1006	 KN 1005		
Langmuir-Blodgett Deposition Troughs (A = Alternate)					
 KN 2001	 KN 2002	 KN 2003		 A = KN 2006	 KN2008
Microscopy Troughs (U = upright, I = inverted)					
 U = KN 3001	 I = KN 3003				
Lite Troughs (L=Langmuir, LB=Langmuir-Blodgett)					
	 L=KN LITE 1003, LB=KN LITE 2002				
Ribbon Barrier Troughs (L = Langmuir, LB = Langmuir-Blodgett)					
	 L = KN 1007 LB = KN 2005				
Liquid-Liquid Troughs					
	 KN 2007		 KN 1004		
STANDARD FRAME		LARGE FRAME	HIGH COMPRESSION FRAME	ALTERNATE FRAME	

Roll-to-Roll Coating Trough

- Coating of large areas
- Flexible substrates such as polymer films

Alternate Coating Trough

- KSV NIMA Alternate Trough is the premium Langmuir-Blodgett Trough
- Capable of coating a substrate automatically using two different materials simultaneously
- Materials can be deposited in any desired order

Liquid-Liquid Troughs

- Extends the capability to use both liquid-liquid and air-liquid interfaces
- Oil & gas, food, cosmetic, pharmaceutical

Microscopy Troughs

- Combine Langmuir to a microscope for additional characterization
- Morphology, phase changes, adsorption
- Different options for upright and inverted microscopes

Lite Troughs

- Cost-efficient L&LB
- High quality systems for limited budget

Ribbon Barrier Trough

- Lung surfactant application
- Other applications where extremely high surface pressures needed

Custom Troughs

- Custom Troughs offered regularly to meet your needs
- Custom dimensions, shapes, materials or applications

Accessories and Characterization

KSV NIMA offers a wide selection of additional tools to assist in your studies. Examples include:

For thin film coatings:

- Langmuir-Schaeffer holder for horizontal deposition
- MicroBAM microscope for floating Langmuir film quality inspection prior to the deposition
- Temperature control and monitoring for controlled deposition environment

For Langmuir studies:

- Surface Potential Meter (SPOT) for molecular orientation studies
- Injection port for adsorption studies
- Interfacial Shear Rheometer (ISR) for emulsion and foam stability studies

KSV NIMA LB Software

KSV NIMA LB software is a powerful tool for creating coatings and studying Langmuir films. Based on 30 years of experience, KSV NIMA LB software includes all the tools needed for effective and easy measurements and data handling.

The versatile measurement modes enable measurements from dipping all the way to compression isotherms, adsorption studies and interfacial rheology.

The measurement features include:

- Coating mode, for depositing material layer, including a coating effectiveness parameter transfer ratio, keeping the packing density constant throughout the dipping
- Compression/relaxation isotherms, for molecular interactions and phase changes
- Isochores/isobars, by keeping the pressure stable automatically and following temperature/area changes
- Monolayer kinetics, for enzyme, polymerization or any other zero-order reactions
- Adsorption and penetration of enzymes, proteins, peptides and similar molecules
- Interfacial rheology, for viscoelastic studies of Langmuir films, for emulsion or foam stability, with oscillating barriers method
- Integrated KSV NIMA characterization tool functions, for easy integration, for example automatic picture taking based on surface pressure when combined to KSV NIMA MicroBAM

For a complete accessory description, please visit biolinscientific.com

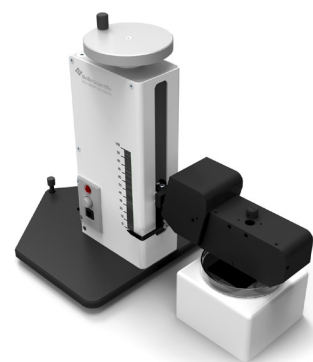

KSV NIMA MicroBAM

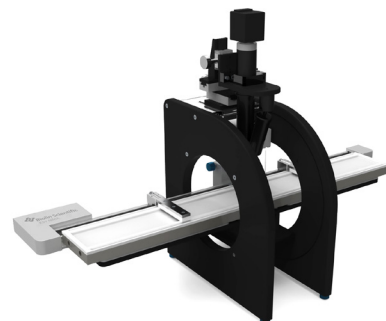

KSV NIMA ISR

KSV NIMA

Roll-to-Roll LB Trough

A special system for high throughput

When the LB deposition process should be semi-continuous to create large coated areas, a special KSV NIMA Roll-to-Roll LB system can be used. Roll-to-Roll LB (R2R LB) is a novel process that broadly widens the possibilities of the LB technology.

In the R2R LB process, a flexible substrate is fed continuously into the trough where it passes through the monolayer of nanoparticles or other material. This enables coating large substrate areas quickly with precise control over the deposition parameters.



KSV NIMA Roll-to-Roll LB Trough

Versatility and high quality

- Roll-to-Roll LB and standard LB/LS coatings - all with the same system
- Adjustable film extraction angle facilitates the coating process for different materials
- Single piece solid PTFE for the easiest cleaning with no contamination
- Uses standardized Wilhelmy method with platinum plate for surface pressure sensing with its ultra-sensitive pressure sensor, with the option to use also disposable paper plates to avoid cleaning
- Adjustable legs, trough top locating pins, barrier limit switches and overflow channels ensure safe and reliable use of the system
- Powerful KSV NIMA LB software integrates all controls and data analysis into the same software, including different characterization tools
- Combine with accessories such as MicroBAM for imaging the layer homogeneity or Syringe Pump for automatic introduction of sample material

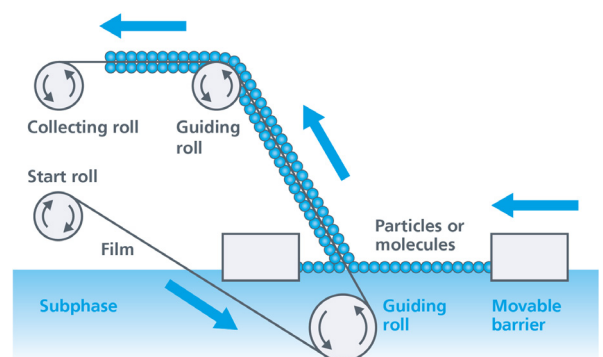
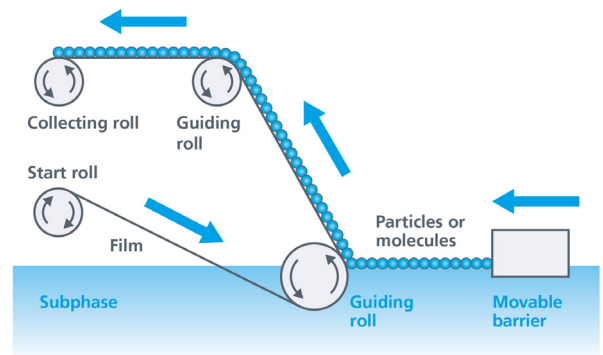

R2R coating process.

	Small	Medium	Liquid-Liquid Medium	Large	Liquid-Liquid High Compression	High Compression	Alternate	Roll-to-Roll
Surface area (cm ²)	98	273	269 (197*)	841	580 (423*)	587	586 (x2**)	2330
Trough top inner dimensions (L x W x H mm)	195 x 50 x 4	364 x 75 x 4	364 x 74 x 7 (364 x 54 x 10*)	580 x 145 x 4	784 x 74 x 7 (784 x 54 x 10*)	782 x 75 x 5	782 x 75 x 5 (x2**)	685 x 340 x 4
Maximum compression ratio	5.2	10.8	10.8	18	24.7	24.7	3.9	-
Barrier speed (mm/min)	0.1...270	0.1...270	0.1...270	0.1...270	0.1...270	0.1...270	0.1...270	0.1...270
Balance measuring range (mN/m)	0...300	0...300	0...300	0...300	0...300	0...300	0...300	0...300
Maximum balance load (g)	1	1	1	1	1	1	1	1
Balance resolution (µN/m)	0.03	0.03	0.03	0.03	0.03	0.03	0.03	0.03
Langmuir trough top	•	•	-	•	•	•	-	-
Total subphase volume (mL)	39	109	-	336	406 (212*)	293	-	-
Langmuir-Blodgett trough top	•	•	•	•	-	-	•	•
Total subphase volume (mL)	57	176	450	578	-	-	1400	5430
Dipping well dimensions (L x W x H mm)	20 x 30 x 30	20 x 56 x 60	20 x 54 x 60	20 x 110 x 110	-	-	Half a circle, radius 75; depth 74	300 x 300 x 50
Maximum sample size (T x W x H mm)	3 x 26 x 26 (1 inch)	3 x 52 x 56 (2 inches)	3 x 50 x 56	3 x 106 x 106 (4 inches)	-	-	3 x 30 x 50 (min height 30 mm)	200 (Substrate width)
Dipping speed (mm/min)	0.1...108	0.1...108	0.1...108	0.1...108	-	-	0.1...108	1...100 (Substrate roll speed)
Extraction angle	-	-	-	-	-	-	-	Adjustable, 30-90 degrees with increments
Upright microscopy trough top	•	-	-	-	-	-	-	-
Inverted microscopy trough top	-	•	-	-	-	-	-	-
Ribbon barrier trough top	-	•	-	-	-	-	-	-
Compatible with								
KSV NIMA ISR	-	-	-	-	•	•	-	-
KSV NIMA MicroBAM	-	•	-	•	-	•	•	•
KSV NIMA SPOT	-	•	•	•	-	•	-	•

• : available
 - : not available/not applicable

* The Liquid-Liquid Trough is deeper than a standard trough as this allows for the two liquid phases.

The value in the brackets corresponds to confinement of the lower phase (other value for the upper phase).

** The Alternate-Layer Deposition Trough is made of two separated compartments for creation of two monolayers simultaneously.



Each of these four colours used in the table correspond to one frame.

All trough tops labelled with the same colour can be placed on the same frame, for modularity.

About us

We are Biolin Scientific. A worldwide company making state of the art instruments and smart solutions for scientists. Knowledge is our greatest resource and an essential part of everything we do. In collaboration with leading universities and industries, we solve challenges to simplify the everyday life in the lab. Our customers are the experts in surface science, and we have the tools for them to progress.



Biolin Scientific

[Progress Together]

Biolin Scientific AB

Hängpilsgatan 7, SE-426 77 Västra Frölunda

Phone: +46 31 769 7690 E-mail: info@biolinscientific.com

www.biolinscientific.com