

Waters™



ELECTROFORCE®  
LOAD FRAME AND  
TESTBENCH INSTRUMENTS



ElectroForce® Load Frames	2
ElectroForce TestBenches	4
ElectroForce Instrument Features	6
ElectroForce Linear Motor	8
Software	10
Load Frame Instruments – 5500	13
Load Frame Instruments – 3200	14
Load Frame Instruments – 3300	16
Load Frame Instruments – 3500	18
TestBench Instruments	20
Planar Biaxial Instruments	22
Applications	24
Accessories	26
Support	28
Specifications	30

ElectroForce® test instruments featuring patented linear motion technologies and WinTest® controls provide a revolutionary approach to mechanical fatigue and dynamic characterization. The ElectroForce family of test instruments includes a full range of force and performance capabilities for a wide variety of test applications based on the most unique motor design in the industry. The end result is billions of cycles of unmatched reliable performance in a dynamic test instrument with precision, accuracy, and ease of use for a wide range of applications.

# ELECTROFORCE® | LOAD FRAMES

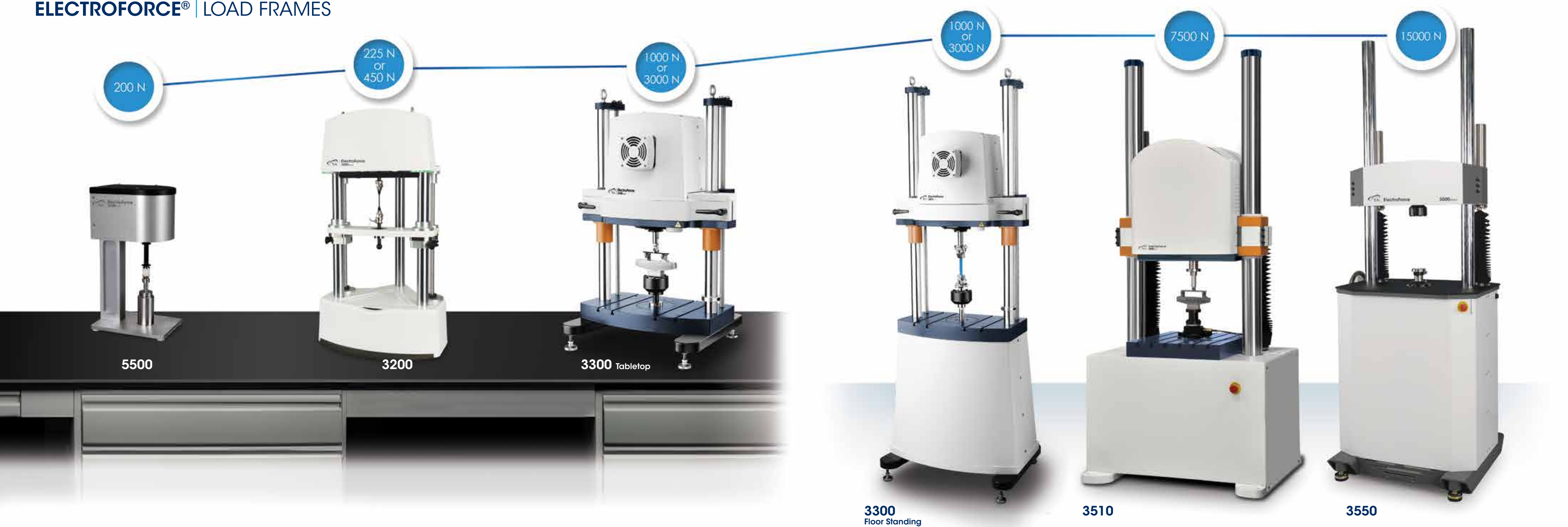

Planar Biaxial TestBench  
with Video Extensometer



200N TestBench with  
Optional Vertical  
Mounting Kit



200N TestBench



Dual 200N TestBench



200N TestBench with Extended Stroke



200N TestBench with Torsion



# ELECTROFORCE® | INSTRUMENT FEATURES

Dynamic  
Reliable  
Energy Efficient  
Frictionless  
Clean  
Environmentally Friendly  
Maintenance-Free  
Quiet

For more than 20 years, ElectroForce test instruments have been successfully utilized in a wide variety of mechanical characterization and fatigue applications.

- Patented linear motor operates without friction, an important feature for ultra-durable and high-precision testing
- Efficient, direct electromagnetic conversion to force results in greater acceleration, high frequencies and high velocities
- Intuitive software design to simplify test setup and a flexible hardware platform for changing test needs
- Powered from a standard electrical outlet, requiring no additional infrastructure, air conditioning or water cooling
- Air-cooled, clean-room compatible and whisper-quiet operation in a compact, space-saving package
- Energy efficient and environmentally friendly by using pollution-free, non-toxic technologies and oil-free design



# ELECTROFORCE® LINEAR MOTOR | TECHNOLOGY

## Reliability that won't let you down

The flexural suspension is engineered to guide the magnet assembly without contact or lubrication. The magnet, coil and stators are designed to control temperatures to eliminate performance degradation over decades of use and deliver maintenance-free operation that you can count on for your longest running tests.

## Unmatched waveform control and fidelity

Without the friction of rolling or sliding bearings, the ElectroForce® motor design provides the control required for the most sensitive of tests. The motor converts even the smallest of increments of current precisely to specimen force, displacement or pressure. This means applied forces can be controlled to gram force ranges and displacements can be controlled to a micron.

## Testing in a variety of environmental conditions

With its efficient, quiet and bearing-free design, the ElectroForce motor is engineered for use in a variety of diverse and challenging environments, including clean rooms, humidity chambers and even radioactive hot cells.

## Sized to meet your requirements

The architecture of the ElectroForce motor can be scaled to accommodate a wide range of forces and displacements:

- Maximum forces from 200 N up to 15 kN
- Maximum displacements from 13 mm up to 50 mm.
- Extended Stroke Options add 150mm displacement.

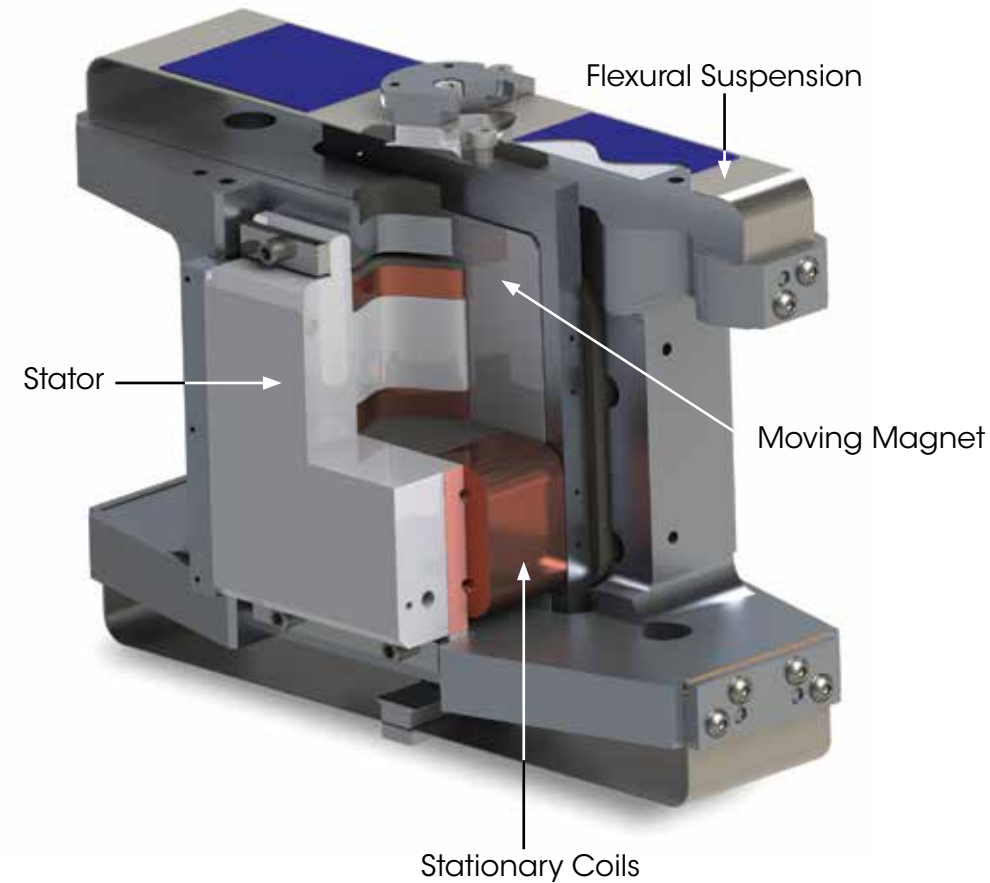

**Design simplicity provides  
unmatched performance & billions  
of maintenance-free cycles**

# The Most Dynamic & Controllable Linear Motor in the Industry

## Bandwidth for any Test: Fast or Slow

ElectroForce® motors excel at the full spectrum of testing speeds, due to the low mass of the rare earth moving magnet and stationary coil design. Testing speeds can range from static tests to one cycle per day, and up to frequencies of 300 Hz.

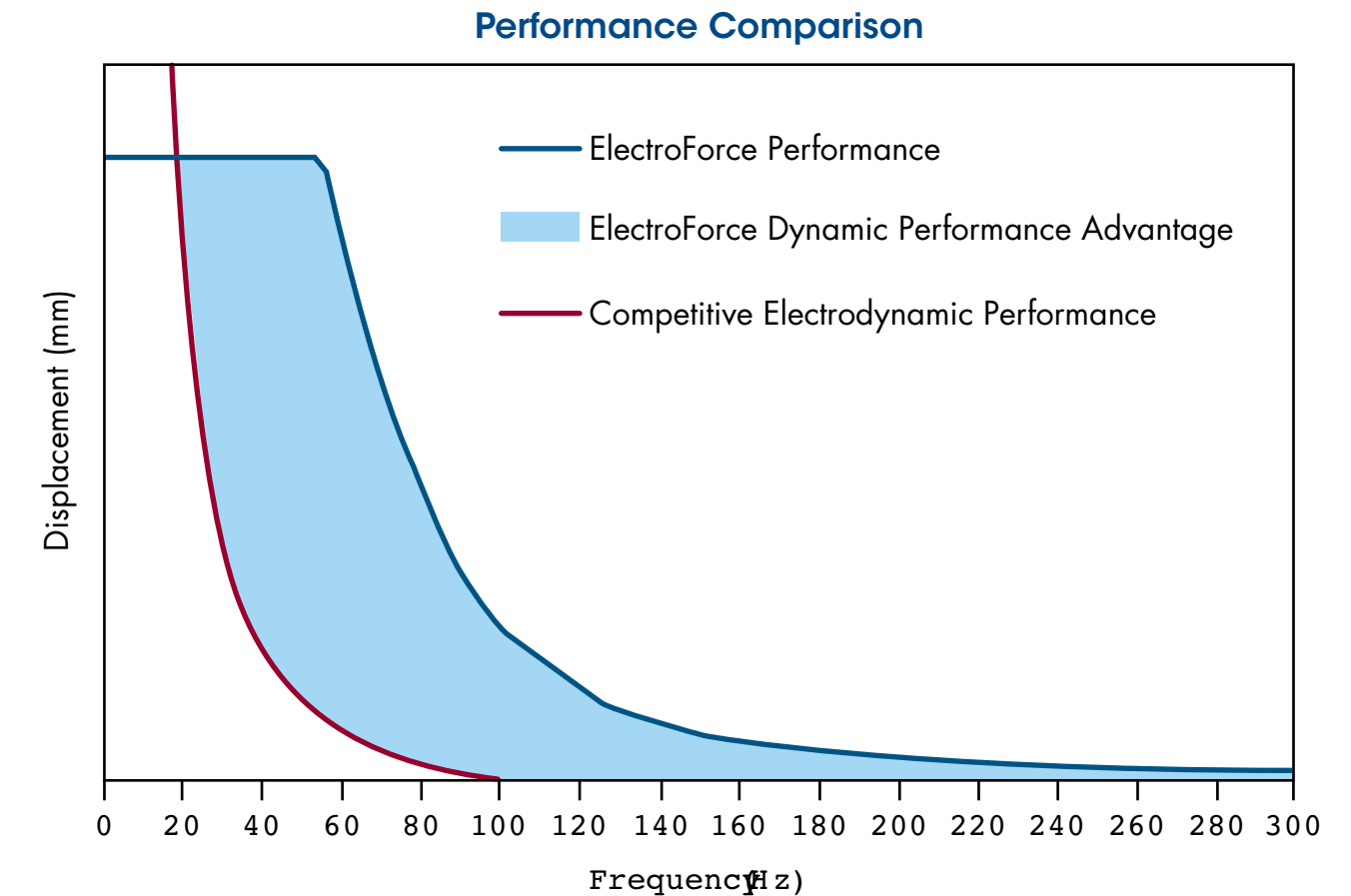

# The Most Flexible Control System Available

Powerful software with intuitive user interface for instrument waveform control and data analysis.

- Comprehensive tool enables quick and easy generation of periodic waveforms (fatigue), ramps (monotonic tests), and more complex block-multiple waveform segments.
- Integrated data acquisition algorithms provide for a variety of data collection techniques including timed acquisition, peak/valley capture, level-crossing, and others
- High speed real-time measurements enable dynamic and precise motor control and up to 10kHz data acquisition rates of sensor and calculated channels
- Advanced controls including multi-channel synchronization of phase and amplitude, and cross-channel compensation
- Advanced limit monitoring and conditional logic features enable users to monitor test performance and automatically change test activity in response to real-time test measurements
- Additional options include:
  - Dynamic Mechanical Analysis
  - External Waveform Input
  - Dynamic Link Library Interface for External Applications

## WinTest® TuneIQ®

### The Most Accurate Closed Loop Control Algorithms

Tune IQ software uses advanced proprietary algorithms to simplify the tuning process

- Provides excellent re-creation of desired waveforms, allowing for improved test control and ultimately better test results
- Allows users to quickly and confidently tune controllers for dynamic linear motors and torsion motors
- Advanced methods that analyze the dynamic response of the system over a wide-range of frequencies, characterizing instrument, sensor and sample for optimal control. This patented multi-frequency approach is superior to a single-point measurement that fails to factor in specimen dynamics

## WinTest DMA (Dynamic Mechanical Analysis)

### A flexible application for advanced viscoelastic property measurements, including:

- Storage Modulus,  $E'$
- Loss Modulus,  $E''$
- Tan Delta,  $\delta$
- Glass Transition
- Secondary Transitions
- Viscoelastic changes during fatigue
- Hysteresis Loop Raw Data

## TRIOS

### Most Versatile Analysis and Plotting Package for DMA Results and Raw Data Files:

- Real-time plotting of DMA results
- Real-time plotting of WinTest raw data
- Comparison of multiple samples' data
- Overlays of WinTest Timed Data and Peak Valley raw data
- Many analysis tools such as Peak identification and integration, Onset point identification, slope fitting, TTS, etc
- User-defined Variables

## (HADS) High Accuracy Displacement Sensor

### The Most Accurate and Precise Displacement Sensor on the Market

- 1 nanometer resolution and micron-level of accuracy
- Far exceeds Class A, ASTM E2309 calibrated accuracy
- Extremely low noise to eliminate the need to filter data
- High responsiveness extends the dynamic performance of system
- Single displacement channel to provide both absolute and high-resolution measurements
- Linear HADS measurement is standard on 3200, 3300 and 3510 Instruments
- Rotation HADS measurement is standard on 3200-AT and 3300-AT instruments

### Sub-micron level noise and control precision, without data filters

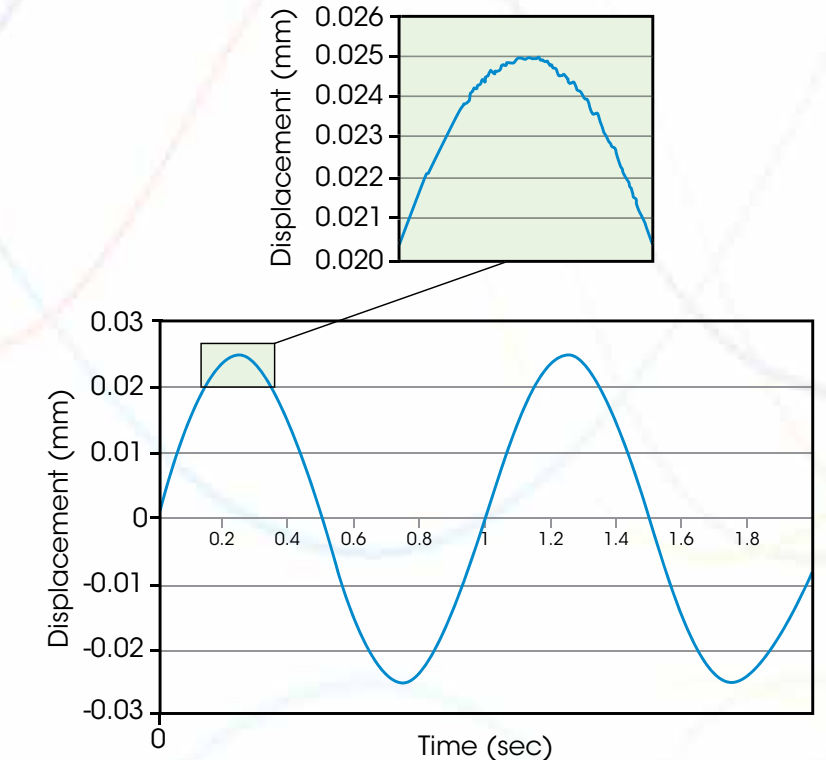

# LOAD FRAME INSTRUMENTS | 5500

The 5500 is a unique single-beam support load frame system offering open architecture for adaptability to the broadest range of applications. It offers a broad force range, durability, and versatility in an affordable design making it an ideal choice for academic laboratories.

### Features and Benefits:

- ElectroForce linear motor capable of precisely controlling force, displacement or strain over a moderate range of frequencies in tension or compression
- Compact package and clean operation for placement into small enclosures such as incubators and glove boxes.
- 3-sided test space access, micro-adjust assembly and convenient fixturing interfaces provide flexibility for many specimen types and geometries
- Optional 24-well Compression Fixture enables many specimens to be loaded simultaneously in a common 24 well cell culture plate
- Interchangeable force sensors and a powerful amplifier enable force control from  $\pm 0.002$  N to  $\pm 200$  N



Specification	Model 5500
Force Range	0.002 – 200 N
Displacement Range	0.025 – 13 mm
Frequency Range	0.0001 – 20 Hz
Instrument Dimensions (HxWxD)	490 x 203 x 269 mm (19.3 x 8.0 x 10.6 in)
Instrument Weight	16 kg (36 lbs)





# LOAD FRAME INSTRUMENTS | 3200

The 3200 Series III load frames are the highest precision and most versatile instruments in their force range. With the highest technology sensors and most advanced frame features, they are the premier choice for demanding test applications requiring wide ranges of force, displacement and frequency.

### Features and Benefits:

- 225 N or 450 N ElectroForce linear motor options capable of precisely controlling force, displacement or strain over a wide range of frequencies in tension or compression
- A wide range of accessories make it one of the most versatile ElectroForce instruments including numerous environmental accessories and motor options
- A tabletop frame that's clean, durable and quiet allow it to be used in virtually any space from office to lab to cleanroom to manufacturing floor.
- The optional torsion motor integrates a high-resolution optical encoder for control and measurements up to 62 turns
- The optional extended stroke motor adds 150 mm of linear motion for high-elongation tests
- Interchangeable force sensors and precise power amplifier enable force control from  $\pm 0.002$  N to  $\pm 450$  N

### Configurations

- 225 N or 450 N Axial Instruments
- Axial Torsion with 5.6Nm torsion motor
- Axial with 150mm Extended Stroke motor
- DMA 3200 specialized configuration for superior Dynamic Mechanical Analysis results (see DMA 3200 Brochure)

### Accessories

- Ovens, fluid baths and bioreactors for simulating a variety of environments
- Lower force sensors to improve data quality for low-force tests
- Numerous grips and fixtures for a variety of specimen geometries
- DMA and other software options



Axial Configuration

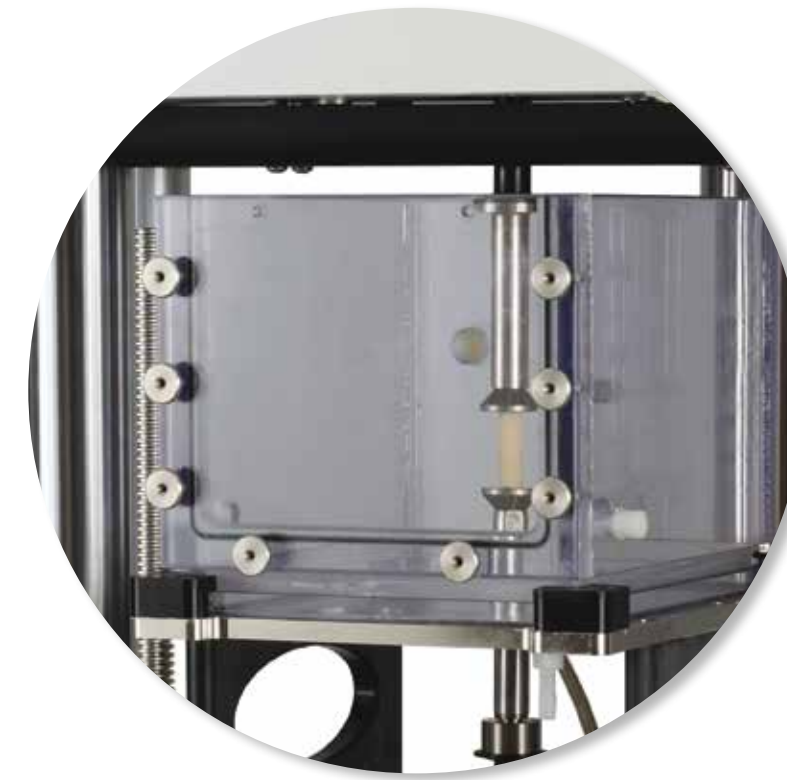

Fluid Bath Accessory



Axial Torsion Configuration

Specification	Model 3220	Model 3230
Force Range	0.002 – 225 N	0.002 – 450 N
Displacement Range	0.002 – 13 mm	0.002 – 13 mm
Frequency Range	0.0001 – 300 Hz	0.0001 – 300 Hz
Instrument Dimensions (HxWxD)	1051 x 579 x 522 mm (42 x 23 x 21 in)	1051 x 579 x 522 mm (42 x 23 x 21 in)
Instrument Weight Axial Configuration	98 kg (215 lbs)	105 kg (230 lbs)

# LOAD FRAME INSTRUMENTS | 3300

The 3300 Series III load frames are highly flexible offering multiple loading ranges and frame configurations. The high performance motor and sensors combined with flexible and convenient frame features make the 3300 the most widely used instrument for testing a broad of materials, components and devices.

### Features and Benefits:

- 1,000 N or 3,000 N ElectroForce linear motor options precisely control force, displacement or strain over a wide range of frequencies in tension or compression
- Multiple frame, motor and environmental accessory combinations allow the instrument to be tailored to a wide variety of applications and sample types.
- Test setup is quick and easy with convenience features of motor-adjustable test space, crosshead locks, Micro-adjust and a T-slot baseplate.
- The optional torsion motor integrates a high-resolution optical encoder for control and measurements up to 62 turns or the Extended Stroke motor option adds 150 mm of linear motion
- Interchangeable force sensors and amplifiers enable force control from  $\pm 0.02$  N to  $\pm 3,000$  N

### Configurations

- 1,000 N or 3,000 N Axial Instruments
- Axial Torsion with 14Nm or 25Nm torsion motor
- Axial with 150mm Extended Stroke motor
- Multi-Specimen Fatigue

### Accessories

- Ovens and fluid baths for simulating a variety of environments
- Lower force sensors to improve data quality for low-force tests
- Numerous grips and fixtures for a variety of specimen geometries
- DMA and other software options



Axial Torsion Configuration with Oven Accessory

Specification	Model 3310	Model 3300
Force Range	0.02 - 1000 N	0.2 - 3000 N
Displacement Range	0.005 - 25 mm	0.005 - 25 mm
Frequency Range	0.0001 - 100 Hz	0.0001 - 100 Hz
Instrument Dimensions (HxWxD) <i>Tabletop Axial Configuration</i>	1283 x 686 x 555 mm (50.5 x 27 x 22 in)	1283 x 686 x 555 mm (50.5 x 27 x 22 in)
Instrument Weight <i>Tabletop Axial Configuration</i>	185 kg (408 lbs)	185 kg (408 lbs)

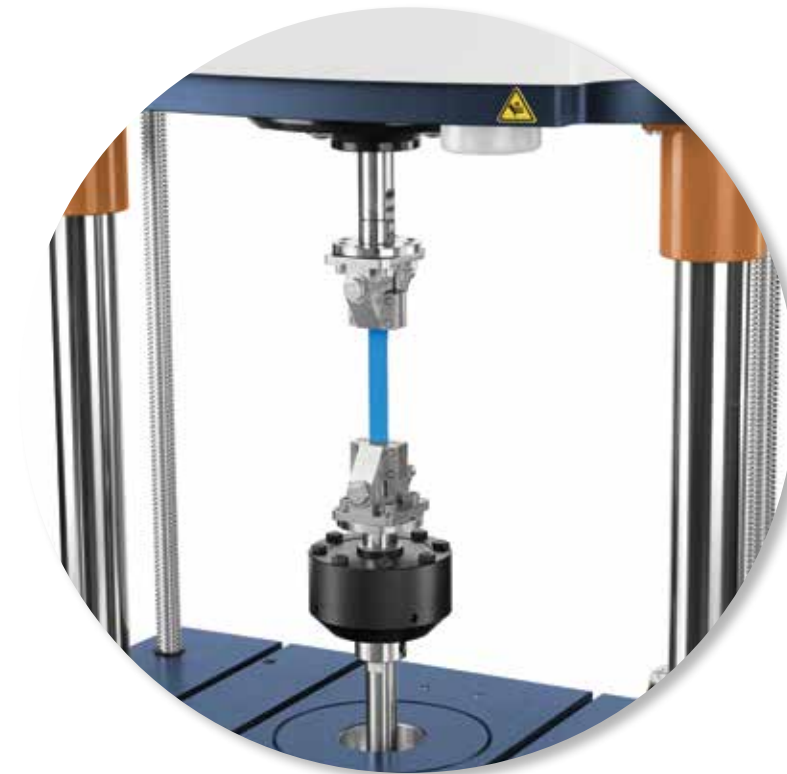

Extended Stroke Configuration



Axial Tabletop Configuration

# LOAD FRAME INSTRUMENTS | 3500

The 3500 series includes the highest force electrodynamic load frames available. With multiple force and frame configurations they deliver up to 15,000N of force for strength and dynamic characterization test of a wide variety of materials, components and devices.

### Features and Benefits:

- 7,500 N or 15,000 N ElectroForce linear motor options for reliably controlling force, displacement or strain over a wide range of frequencies in tension or compression
- Multiple frame, motor and environmental accessory combinations allow the instrument to be tailored to a wide variety of applications and sample types.
- HADS displacement sensor is standard on the 3510 Series II for even higher resolution and accuracy of displacement measurements.
- Torsion motors offer multi-turn capability with measurements up to 40 turns.
- Interchangeable force sensors and amplifiers enable force control from  $\pm 1$  N to  $\pm 15,000$  N

### Configurations

- Upper motor 7,500 N (Model 3510)
- Lower motor 15,000 N (Model 3550)
- Axial Torsion with 49Nm or 70Nm torsion motor is available for each model

### Accessories

- Ovens and fluid baths for simulating a variety of environments
- Lower force sensors to improve data quality for low-force tests
- Numerous grips and fixtures for a variety of specimen geometries
- DMA and other software options

Specification	Model 3510	Model 3550
Force Range	1 – 7,500 N	1 – 15,000 N
Displacement Range	0.010 – 50 mm	0.025 – 50 mm
Frequency Range	0.0001 – 100 Hz	0.0001 – 50 Hz
Instrument Dimensions (HxWxD) <i>Axial Configuration</i>	2510 x 979 x 813 mm (99 x 39 x 32 in)	2498 x 861 x 756 mm (98 x 34 x 30 in)
Instrument Weight <i>Axial Configuration</i>	1000 kg (2200 lbs)	816 kg (1800 lbs)



3510 Axial Configuration



3550 Axial Torsion with Oven Accessory

# TESTBENCH INSTRUMENTS

The TestBench series is a highly flexible mechanical test platform built upon a breadboard that enables user to relocate and orient motors and force sensors in multiple configurations. This offers a uniquely open platform for demanding and creative test solutions across a variety of applications.

### Features and Benefits:

- 200 N and 400 N ElectroForce linear motors capable of precisely controlling force, displacement or strain over a wide range of frequencies in tension or compression
- Multiple motor combinations offering dynamic axial, long-stroke axial and rotational motions that can be oriented and synchronized in virtually any combination.
- Interchangeable force sensors and powerful amplifiers enable force control from  $\pm 0.002$  N to 400 N

### Configurations

- 200 N TestBench with Optional 5.6 Nm Torsion or 150 mm Stroke Extension motor
- 400 N TestBench with Optional 5.6 Nm Torsion or 150 mm Stroke Extension motor
- Multi-Station configurations

### Accessories

- Numerous grips and fixtures for a variety of specimen geometries
- Fluid bath and vertical mount legs available for 200 N and 400 N models
- Lower force sensors to improve data quality for low-force tests
- DMA and other software options

Specification	200N TestBench	400N TestBench
Force Range	0.002 - 200 N	0.002 - 400 N
Displacement Range	0.025 - 13 mm	0.025 - 13 mm
Frequency Range	0.0001 - 100 Hz	0.0001 - 100 Hz
Instrument Dimensions (HxWxD) <i>Axial Configuration</i>	267 x 1038 x 610 mm (10.5 x 41 x 24 in)	286 x 1073 x 610 mm (11.3 x 42 x 24 in)
Instrument Weight <i>Axial Configuration</i>	64.4 kg (142 lbs)	69.6 kg (153 lbs)

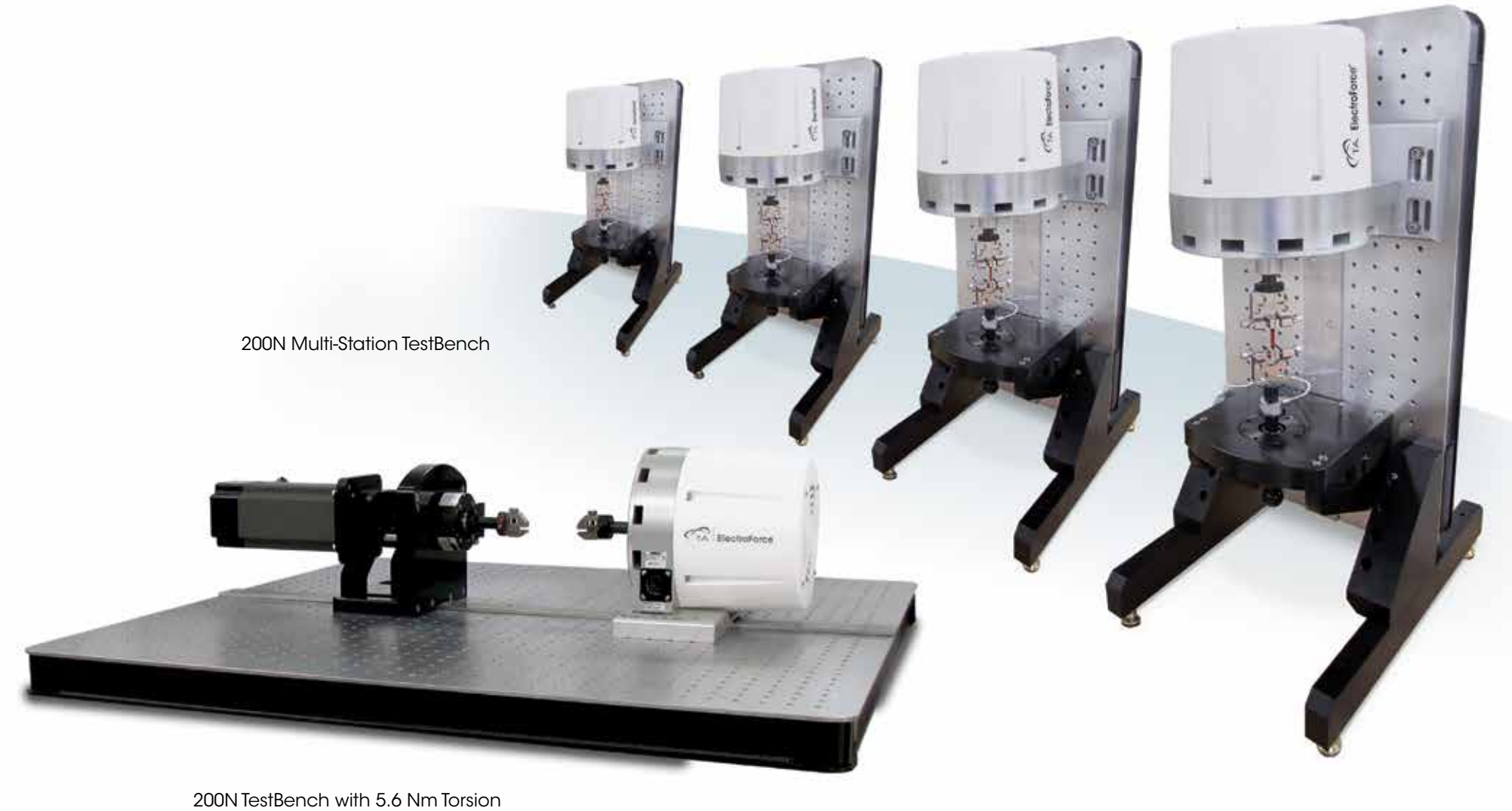

200N Multi-Station TestBench

200N TestBench with 5.6 Nm Torsion

# PLANAR BIAxIAL INSTRUMENTS

The Planar Biaxial instruments are special configurations of the TestBench series designed for precise characterization of planar samples such as membranes, textile, skin and pericardium. Multiple motors can be synchronized in various control modes and phase for almost unlimited combinations of planar loading.

## Features and Benefits:

- Two or Four 200 N ElectroForce® linear motors arranged orthogonally for precise quasi-static or dynamic loading of planar samples
- Direct control of each axes' displacement or force plus phase enables a wide variety of test methods
- The 4-motor configuration offers the additional capability of stationary specimen center with each pair of motors acting equal-and-opposite.
- Interchangeable force sensors and precise power amplifiers enable force control from  $\pm 0.002$  N to  $\pm 200$  N

## Accessories

- Hook grips for isolating loading axes
- Fluid bath
- Lower force sensors to improve data quality for low-force tests
- Digital Video Extensometer (DVE) for real-time strain measurements
- Interface kits for synchronizing with 3rd party DIC solutions

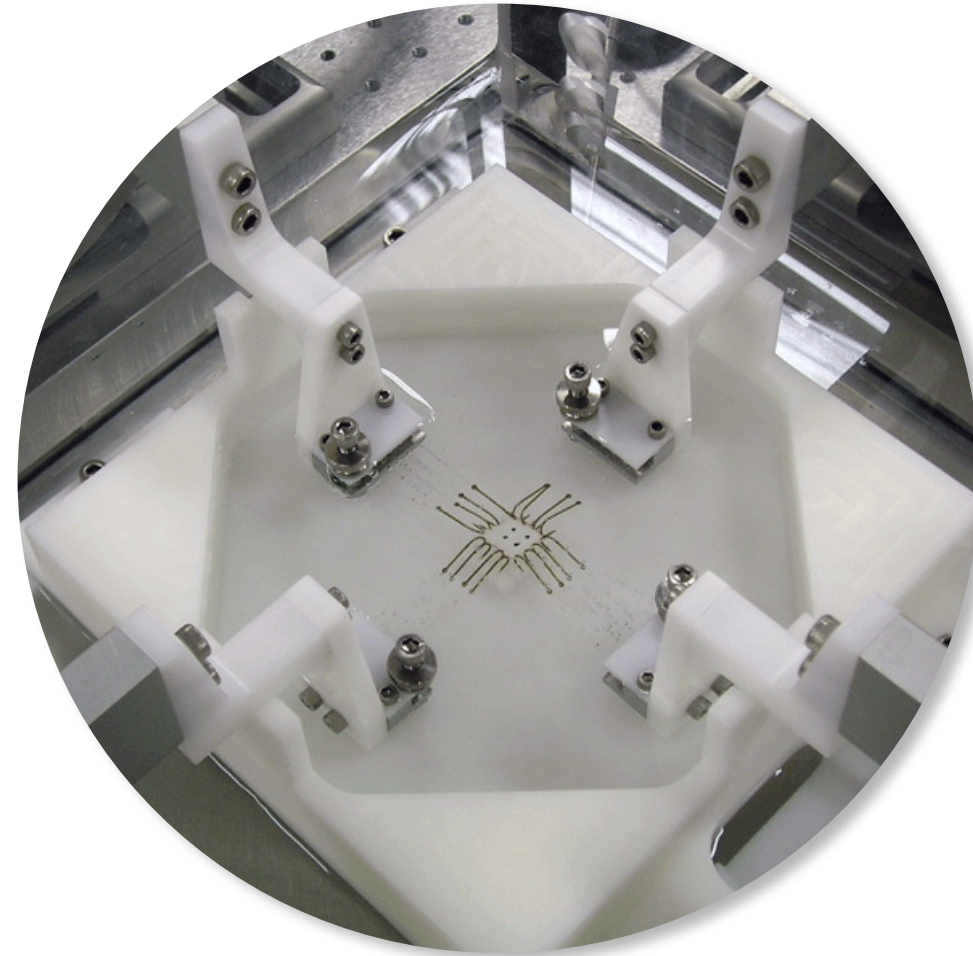

Fluid Bath with Hook Grip Accessory

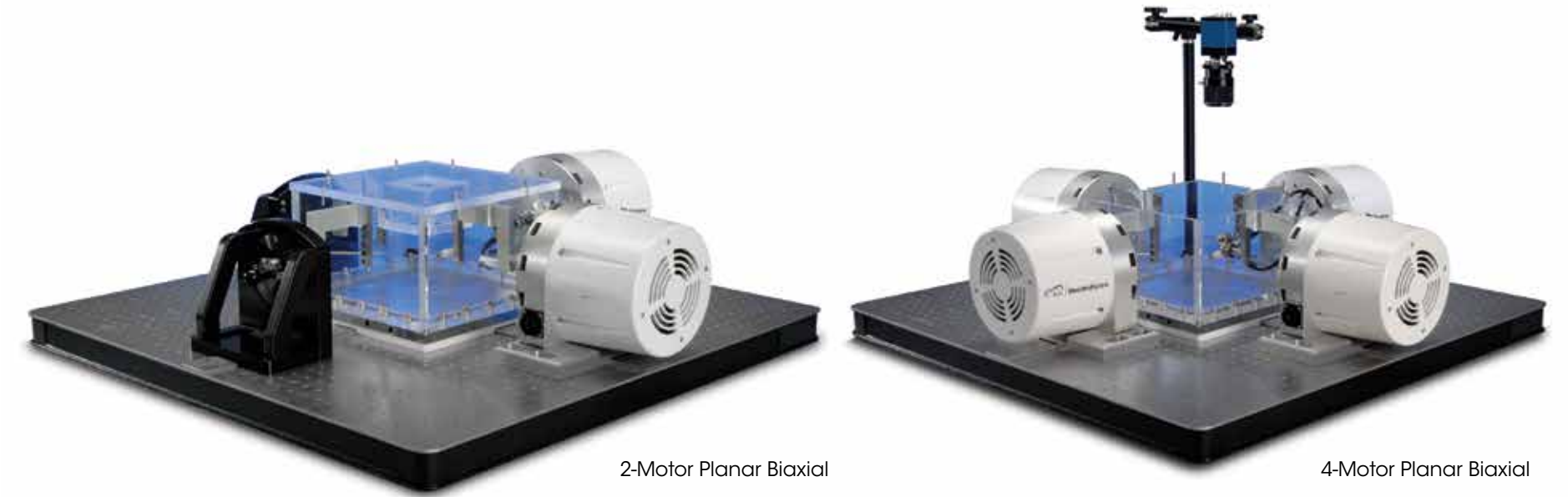

2-Motor Planar Biaxial

4-Motor Planar Biaxial

Specification	2-Motor Planar Biaxial	4-Motor Planar Biaxial
Force Range	0.002 – 200 N	0.002 – 200 N
Displacement Range	0.025 – 13 mm	0.050 – 26 mm
Frequency Range	0.0001 – 100 Hz	0.0001 – 100 Hz
Instrument Dimensions (HxWxD)	267 x 1000 x 1000 mm (10.5 x 39 x 39 in)	286 x 1086 x 1086 mm (10.5 x 43 x 43 in)
Instrument Weight	102 kg (225 lbs)	110 kg (243 lbs)

# APPLICATIONS | FATIGUE, DURABILITY & MATERIAL CHARACTERIZATION

Medical  
Devices



Electronics

Elastomers

Aerospace

Biomaterials

Composites

Polymers

Automotive

Tissue Engineering



The design of new materials and products requires a thorough assessment of material properties and complete performance evaluation within the customer's intended end-use. A variety of basic and advanced testing techniques are available to meet this need.

- Tension/Compression
- Bending
- Torsion
- Shear
- Multi-axial
- Failure Testing
- Fatigue
- Dynamic Characterization
- Creep
- Stress Relaxation
- Accelerated Life Testing

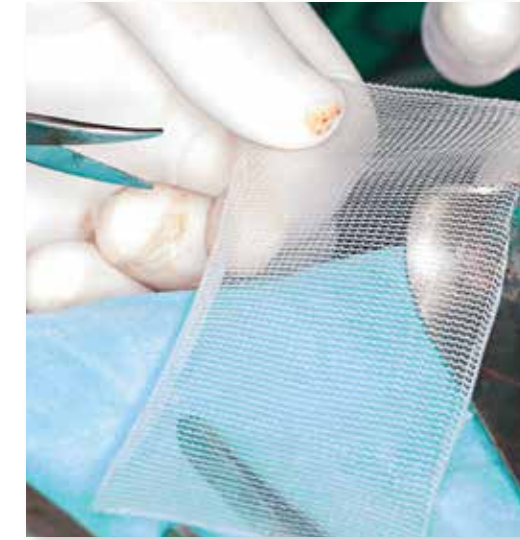

Your **Success**  
our **Mission™**

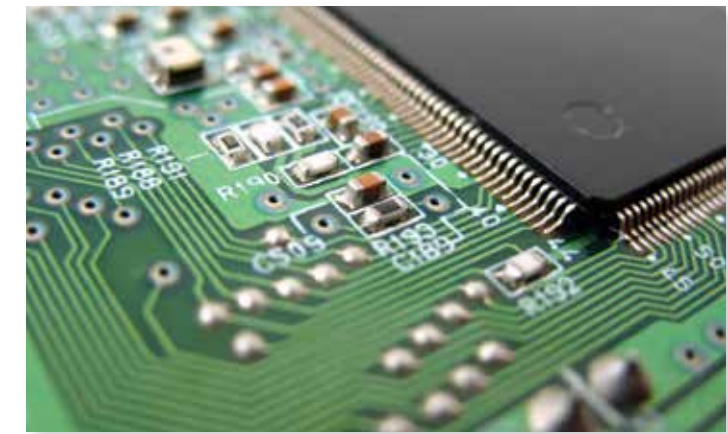

# ACCESSORIES

ElectroForce® test instruments can be integrated with a variety of specimen fixtures, sensors, environmental chambers, fluid baths, and optional software.

## Grips/Platens

- Tension/Torsion Grips
- Wedge Grips
- DMA Grips
- Tissue Grips:
  - Thermal-Electrically Cooled
- Compression Platens
- 3- and 4-Point Bend

## Sensors

- Force/Torque
- Displacement/Rotation
- Strain
- Pressure
- Acceleration
- Submersible Force Sensors

## Fixtures and Chambers

- Multi-specimen Fixture
- Saline Baths
- Hot/Cold Chambers
- Furnaces
- 24-well Plate Fixture
- T-Slot

## Upgrade Options

- Axial Torsion
- Extended Stroke
- Vertical Mount
- System Status Indicator (SSI) Lights
- Battery Backup

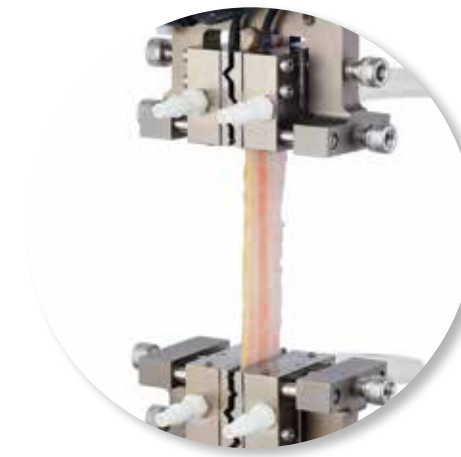
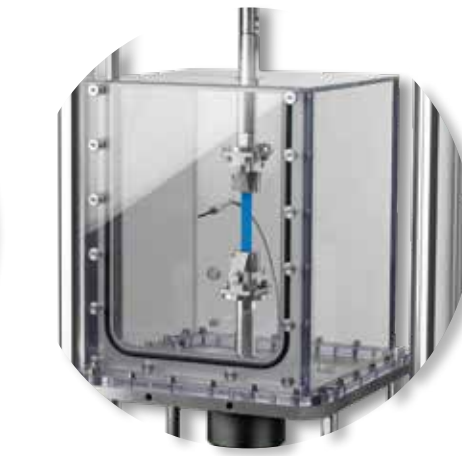
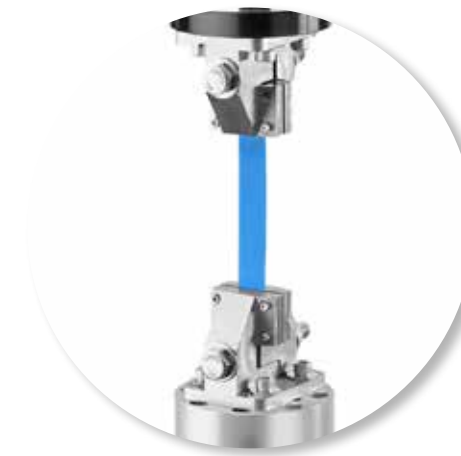

# Industry-Leading Sales & Support

TA Instruments' leadership position results from the fact that we offer the best overall product in terms of technology, performance, quality, and customer support. While each is important, our demonstrated commitment to after-sales support is a primary reason for the continued loyalty of our customers. To provide this level of support, TA Instruments has assembled the largest worldwide team of field technical and service professionals in the industry. Others promise good service. Talk to our customers and learn how TA Instruments consistently delivers on our promise to provide exceptional service.

With direct support staff in **24 countries** and **5 continents**, TA Instruments can extend its exceptional support to you, wherever you are.





# SPECIFICATIONS

	5500	3200	3300
<b>Linear Motor</b>			
Standard			
Peak/Max Sine	± 200 N	± 225 N	± 1000 N
Static or RMS (continuous)	± 140 N	± 160 N	± 700 N
High Force Option			
Peak/Max Sine	—	± 450 N	± 3000 N
Static or RMS (continuous)	—	± 320 N	± 2100 N
Displacement	13 mm	13 mm	25 mm
Extended Stroke Option	—	150 mm	150 mm
<b>Linear Velocity</b>			
	0.0065 µm/s – 0.80m/s	0.0065 µm/s – 3.2 m/s	0.013 µm/s – 1.5 m/s <sup>[1]</sup> 0.013 µm/s – 2.0 m/s <sup>[2]</sup>
<b>Frequency</b>			
Fatigue	0.00001 Hz – 20 Hz	0.00001 Hz – 300 Hz	0.00001 Hz – 100 Hz
DMA	0.01 Hz – 20 Hz	0.01 Hz – 200 Hz*	0.01 Hz – 75 Hz*
<b>Torsional Motor Option</b>			
Standard			
Peak/Max	—	± 5.6 N-m	± 14 N-m <sup>[3]</sup> / ± 25 N-m <sup>[4]</sup>
Static or RMS (continuous)	—	± 5.6 N-m	± 14 N-m <sup>[3]</sup> / ± 25 N-m <sup>[4]</sup>
High Torque Option			
Peak/Max	—	—	—
Static or RMS (continuous)	—	—	—
Rotation			
	—	Multi-turn 62 revolutions	Multi-turn 62 revolutions
<b>Thermal Chamber Option</b>			
	—	-150 to 315 °C -150 to 600 °C <sup>[5]</sup>	-150 to 350°C
<b>Fluid/Saline Bath Option</b>			
	Ambient to 40 °C	Ambient to 40 °C	Ambient to 40 °C

— Not Available

**Notes:**

- <sup>[1]</sup> Linear Velocity on ElectroForce® 3310
- <sup>[2]</sup> Linear Velocity on ElectroForce 3330
- <sup>[3]</sup> Torque capacity on ElectroForce 3310
- <sup>[4]</sup> Torque capacity on ElectroForce 3330
- <sup>[5]</sup> Temp Range for DMA 3200 with FCO Oven

\*This frequency specification applies without the temperature controlled oven. The DMA frequency is reduced when used with the oven.

Specifications are subject to change

	3510	3550	200N/400N Test Bench
<b>Linear Motor</b>			
Standard			
Peak/Max Sine	± 7500 N	± 15000 N	± 200 N
Static or RMS (continuous)	± 5300 N	± 10600 N	± 140 N
High Force Option			
Peak/Max Sine	—	—	± 400 N
Static or RMS (continuous)	—	—	± 280 N
Displacement	50 mm	50 mm	13 mm
Extended Stroke Option	—	—	150 mm
<b>Linear Velocity</b>			
	0.025 µm/s – 1.5 m/s	0.025 µm/s – 1.5 m/s	0.0065 µm/s – 3.2 m/s
<b>Frequency</b>			
Fatigue	0.00001 Hz – 100 Hz	0.00001 Hz – 50 Hz	0.00001 Hz – 100 Hz
DMA	0.01 Hz – 40 Hz*	0.01 Hz – 25 Hz	0.01 Hz – 75 Hz
<b>Torsional Motor Option</b>			
Standard			
Peak/Max	± 49 N-m	± 49 N-m	± 5.6 N-m
Static or RMS (continuous)	± 42 N-m	± 42 N-m	± 5.6 N-m
High Torque Option			
Peak/Max	± 70 N-m	± 70 N-m	—
Static or RMS (continuous)	± 50 N-m	± 50 N-m	—
Rotation			
	Multi-turn 40 revolutions	Multi-turn 40 revolutions	Multi-turn 40 revolutions
<b>Thermal Chamber Option</b>			
	-150 to 350 °C	-150 to 350 °C	—
<b>Fluid/Saline Bath Option</b>			
	Ambient to 40 °C	—	Ambient to 40 °C



## AMERICAS

New Castle, DE USA  
Lindon, UT USA  
Wakefield, MA USA  
Eden Prairie, MN USA  
Chicago, IL USA  
Costa Mesa, CA USA  
Montreal, Canada  
Toronto, Canada  
Mexico City, Mexico  
São Paulo, Brazil

## EUROPE

Hüllhorst, Germany  
Bochum, Germany  
Eschborn, Germany  
Wetzlar, Germany  
Elstree, United Kingdom  
Brussels, Belgium  
Etten-Leur, Netherlands  
Paris, France  
Barcelona, Spain  
Milano, Italy  
Warsaw, Poland  
Prague, Czech Republic  
Sollentuna, Sweden  
Copenhagen, Denmark

## ASIA & AUSTRALIA

Shanghai, China  
Beijing, China  
Tokyo, Japan  
Seoul, South Korea  
Taipei, Taiwan  
Guangzhou, China  
Petaling Jaya, Malaysia  
Singapore  
Bangalore, India  
Sydney, Australia



**TA Instruments**

159 Lukens Drive  
New Castle, DE 19720 U.S.A.  
T: 1 302 427 4000  
F: 1 302 427 4041  
[www.tainstruments.com](http://www.tainstruments.com)

**Waters Corporation**

34 Maple Street  
Milford, MA 01757 U.S.A.  
T: 1 508 478 2000  
F: 1 508 872 1990  
[www.waters.com](http://www.waters.com)