



Surface Measurement Systems
World Leader in Sorption Science

DVS Carbon

CO₂ and H₂O Gravimetric Sorption Analyzer
Under Real World Conditions



Gravimetric precision and humidity control for applications in carbon capture, utilization, and storage.

DVS Carbon

The world's most advanced gravimetric CO₂ capture analyzer

The latest addition to the DVS family, the DVS Carbon is the first purpose-built gravimetric sorption analyzer for advanced carbon capture conditions. In most gas phase carbon capture applications, CO₂ often competes with other chemical species at adsorbent sites, especially water vapor. The new DVS Carbon enables the measurement of CO₂ uptake in real life conditions, controlling both temperature and humidity at a broad range of CO₂ concentrations.

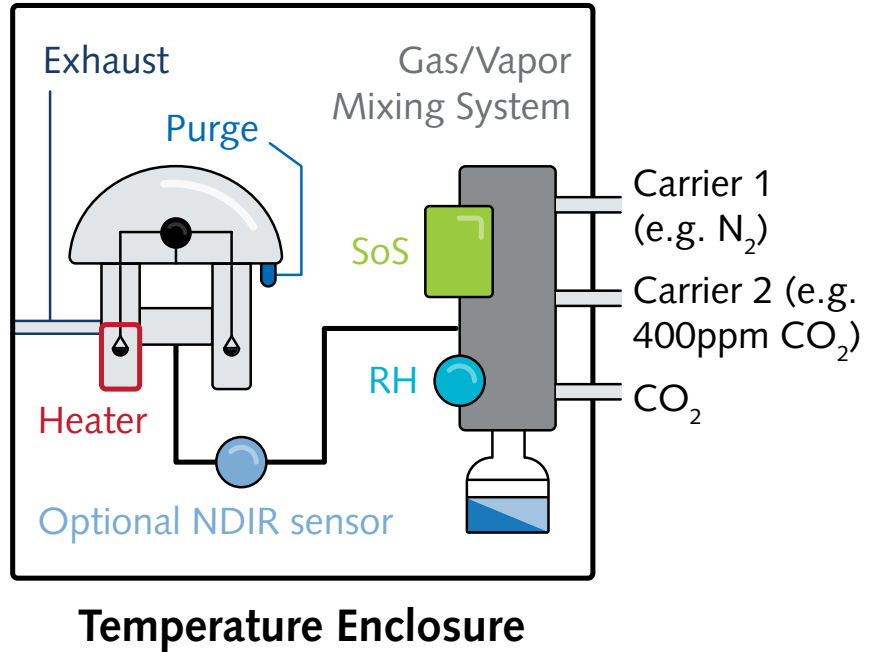

Carbon Capture, Utilization, & Storage (CCUS) Applications:



Post-combustion capture (PCC)



Carbon sequestration

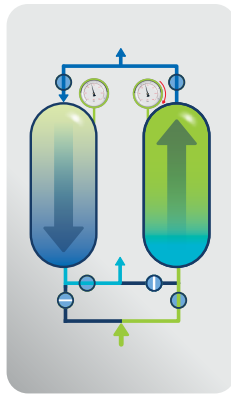

Temperature/moisture swing sorption



Direct air capture (DAC)



Solid sorbent characterization

What is DVS?

Dynamic Vapor Sorption (DVS) is a gravimetric sorption technique that monitors sample mass change across varying concentrations to measure how quickly and how much of a gas or vapor is sorbed by a sample. Learn more on the back cover.

Key Features

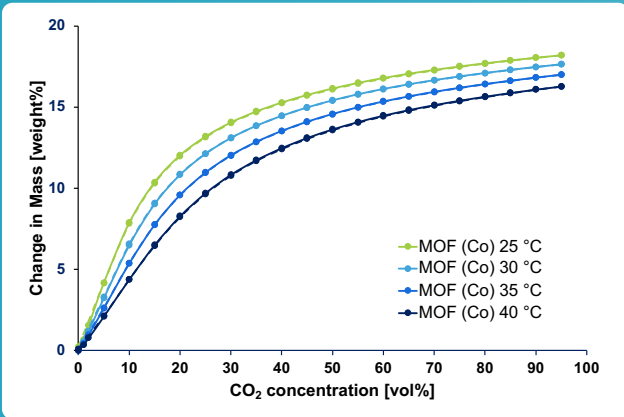

Figure 1: CO₂ uptake as a function of temperature for a Cobalt-based MOF sample. Adsorption and desorption are seen as fully reversible.

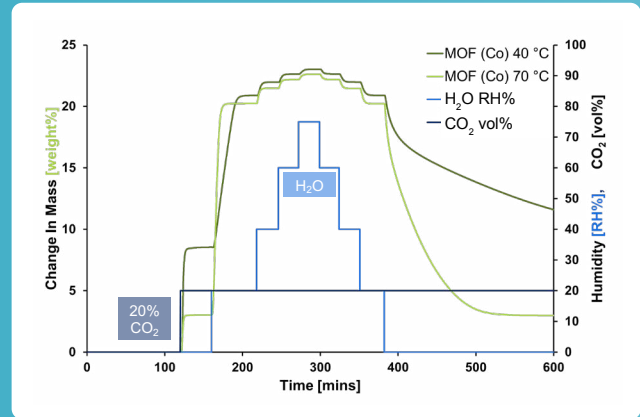

Figure 2: Co-sorption of water at 40 °C and 70 °C in the presence of 20 vol% CO₂. Total capacity is not affected by experimental temperature.

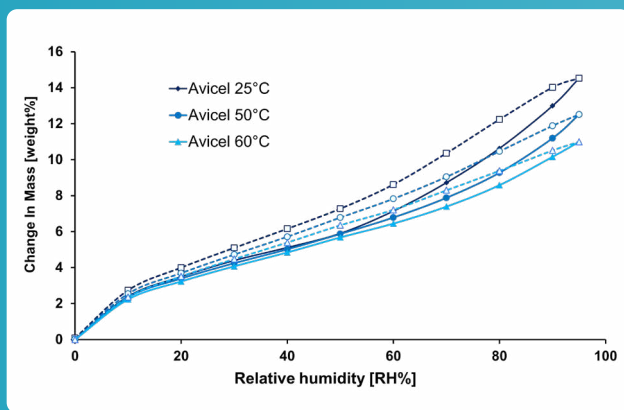

Figure 3: Isotherms of water on a hydrophobic support at increasing temperatures.

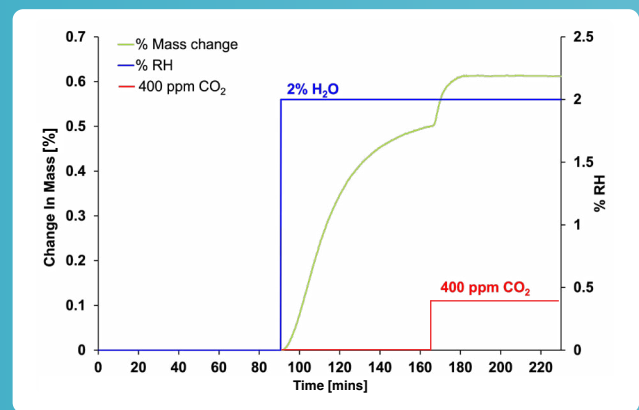

Figure 4: Kinetic plot of CO₂ uptake at atmospheric levels of an amine functionalized carbon, with 2% background of relative humidity. A noticeable increase in mass is observed when 400 ppm CO₂ is introduced.

Independent multicomponent control

- Concentration of CO₂ and H₂O can be individually controlled
- Cycling or complex sorption programs are easily created
- Concentration and temperature changed in precise steps or ramps (Fig 2 & 4)

Isotherms of CO₂ and H₂O

- CO₂ (Fig 1) and water isotherms (Fig 3) in realistic conditions
- Kinetics for each step available by default

Multiple concentration & temperature ranges for all CCUS applications

- High percent level (Fig 2) or low ppm range (Fig 4) CO₂ can be controlled, suitable for DAC, PCC, or other CCUS conditions
- Lower CO₂ concentrations (e.g. 400 ppm) are generated using a pre-diluted gas cylinder

In-situ activation and regeneration

- Sample can be locally heated up to 300° C under inert or process gas
- Drying, activation, or regeneration kinetics determined directly

Balance, Temperature, and Humidity Stability

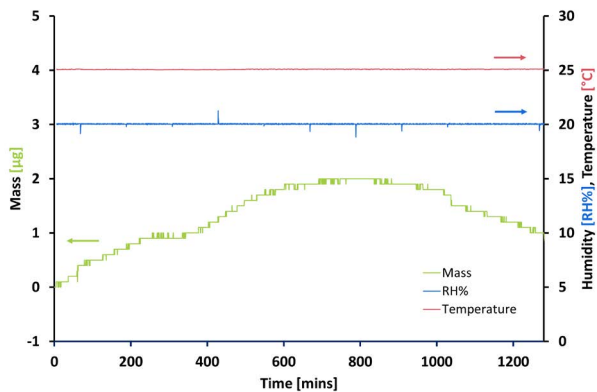

Figure 5: Baseline at 20% RH over 24 hours

The SMS UltraBalance is a custom-built symmetric microbalance that measures microgram changes in sample weight. Temperature control ensures long-term stability, even under dry and humid conditions.

- Mass changes at a resolution of 0.01 µg (for low mass balance)
- Root mean square noise of ≤ 0.3 µg for low mass balance (averaged over 24 hours)

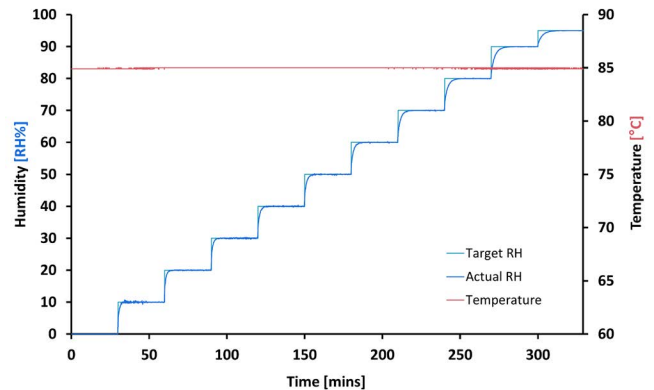

Figure 6: Stability and range of humidity generation at 85 °C

An advanced mixing system and calibrated mass flow controllers enable the DVS Carbon to generate accurate concentrations of CO₂ and humidity.

- Factory-calibrated with salt at 25 °C and 70 °C
- Achieves high humidity (<85%), even at high temperatures (<85 °C), without condensation
- Accurate humidity control with 0.1% RH stability over 6 hours
- Large 500 mL heated water reservoirs

Humidity and CO₂ Range

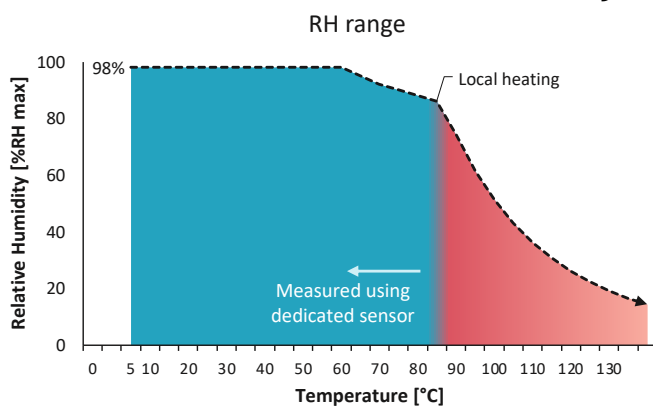

Figure 7: Accessible humidity as a function of temperature

Thanks to a precisely tuned temperature enclosure, heated water reservoirs, and calibrated sensors, accurate high relative humidity is achievable in the enclosure operating temperature range.

An extended range of reduced RH is accessible using local heating up to 300 °C.

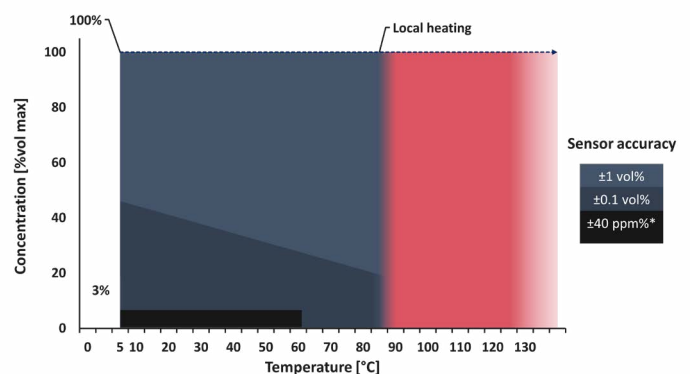

Figure 8: Accessible CO₂ concentration as a function of temperature
* Requires DVS Carbon Advanced

CO₂ concentrations can be generated by mixing pure CO₂ with a carrier gas.

Our patented SoS sensor affords accurate measurements with CO₂ concentrations up to 100 vol%, and an increased resolution below 50%. A non-dispersive infrared (NDIR) sensor can be installed for measuring CO₂ down to 50 ppm.

Speed of Sound Sensor

The speed of sound is an intrinsic property of gas or vapor measured in sorption experiments. It depends on gas/vapor temperature, concentration, and species. Surface Measurement Systems redesigned its patented Speed of Sound (SoS) Sensor to provide the most accurate real-time precision. Meaning this compact device enables controlled generation across a range of concentrations, without the need for large, complex machinery.

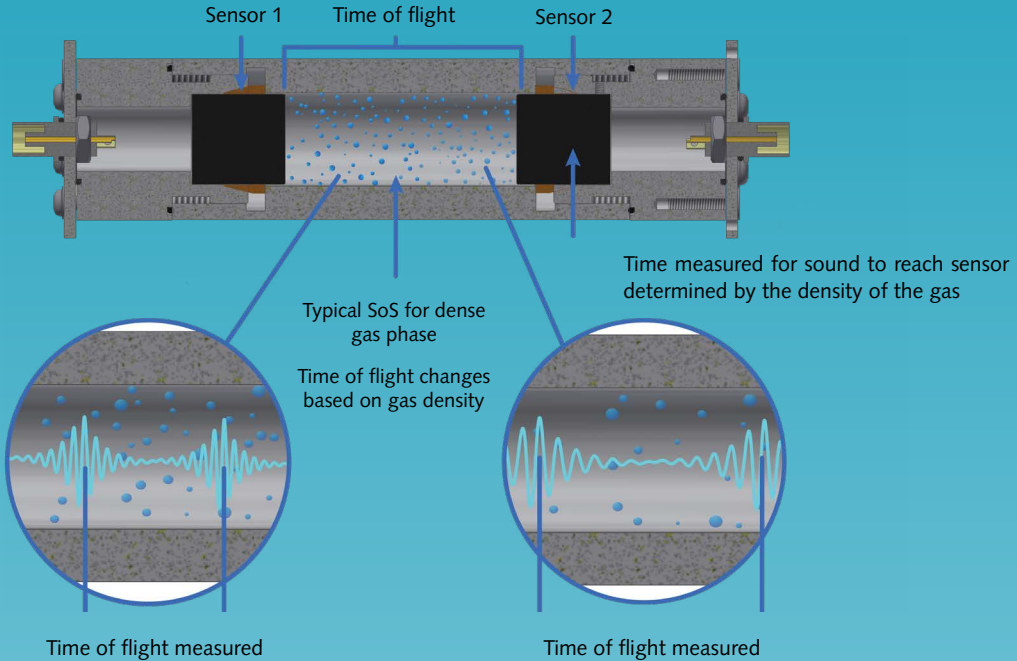

Comparing DVS Carbon Models

	DVS Carbon Standard	DVS Carbon Advanced
Generate 100 vol% CO ₂ by CO ₂ & carrier gas mixing, measured by SMS patented Speed of Sound Sensor	✓	✓
Humidity generation up to 98 RH% across wide temperature range with heated water reservoirs	✓	✓
Sample activation or high temperature sorption experiments up to 300 °C with local heater	✓	✓
Seamless carrier gas switching * (e.g. between pure nitrogen and 400 ppm CO ₂ in N ₂)	✓	✓
Generation of CO ₂ and H ₂ O mixtures in a carrier gas, in subject to limits of individual component concentration [vol%CO ₂ + RH%] < 100	✓	✓
Mixing capabilities for low concentrations of CO ₂ (e.g. 50 ppm to 1000 ppm) **, including a second NDIR CO ₂ sensor*** for ppm CO ₂ levels		✓
Independent dynamic control & mixing of CO ₂ and H ₂ O to enable greatly extended CO ₂ /RH generation (e.g. increasing CO ₂ concentration from 0 to 100% at a constant 50% water saturation)		✓

* Sensor accuracy is unspecified on carrier gases that contain less than 99% N₂ or air, ** Requires pre-calibrated CO₂ cylinder, *** 2nd NDIR sensor limits max. temp. to 60°C when installed

Case Study: Post Combustion

Zeolite 13X is a sodium-exchanged aluminosilicate zeolite with a faujasite topology and an effective pore size of around 0.9-1 nm. It is often used in industrial gas separations, such as oxygen production, gas drying, or desulfurization. Due to its high uptake of CO_2 , it was investigated for its capture in flue gas conditions. Unfortunately, its extremely high affinity for water means that CO_2 adsorption is inhibited in humid conditions, as H_2O competes and occupies the micropores.

The DVS Carbon was used to examine the uptakes of two components, and to evaluate the impact of humidity on CO_2 capture. An initial CO_2 isotherm shows a high uptake for carbon dioxide, of nearly 15 weight%.

To evaluate co-adsorption conditions, a second CO_2 isotherm is recorded with 5% RH of background relative humidity. The introduction of CO_2 induces a negligible increase in mass, highlighting that the sorption sites and pores are already occupied by water.

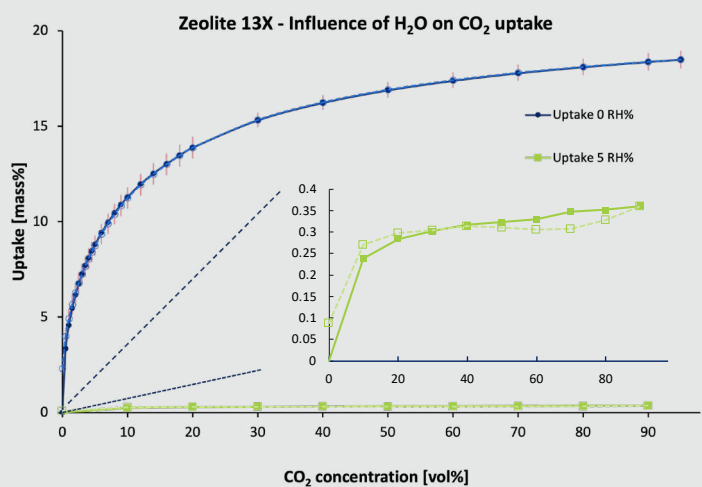

Figure 9: Impact of constant humidity (5 RH%) on CO_2 uptake at 25 °C on Zeolite 13X in a N_2 carrier flow. Inset shows zoom of isotherm on 5 RH%, assuming no displacement of water by CO_2

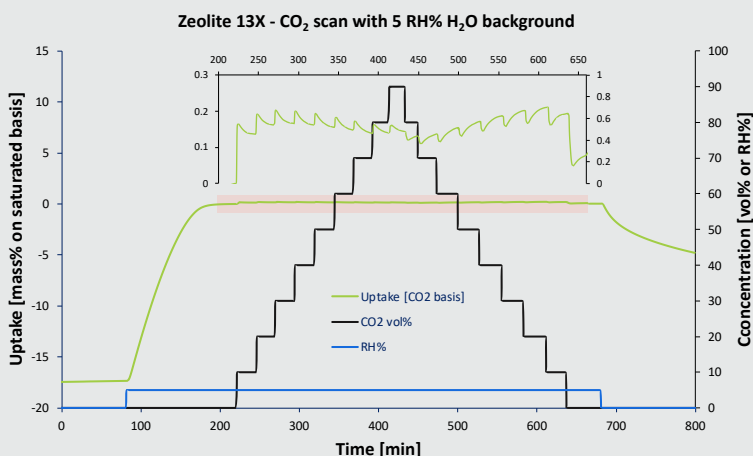

Figure 10: Kinetics of uptake when CO_2 is changed at a constant 5 RH% on Zeolite 13X at 45°C. Inset is a zoom of mass change during CO_2 scanning

Observing the kinetics in detail, a small displacement effect can be observed. Nevertheless, as has been also proven by breakthrough studies, the uptake for CO_2 decreases by a factor of 10. An interesting observation is that the kinetics of water sorption are slow compared to CO_2 . This could allow kinetic-driven, rather than equilibrium-driven separation processes with Zeolite 13X.

Case Study: Direct Air Capture

Direct air capture (DAC) is an ambitious initiative to capture CO₂ from the ambient air. This endeavour is challenging due to the low concentration of carbon dioxide in the atmosphere, around 400 ppm. Amines are promising for this application due to their high affinity for carbon dioxide. Functionalizing amine groups or impregnating amines on various porous supports helps to mitigate issues such as accessibility, degradation, and vaporization. The influence of water is particularly important, as its presence can reduce or even enhance the capacity for CO₂.

Uptakes on two different types of supported amines have been evaluated. In one case, humidity was changed in the presence of low concentrations of CO₂ to study total uptakes. In another, steps of each component were introduced, to study in-depth the kinetics of adsorption in the presence of individual and combined components.

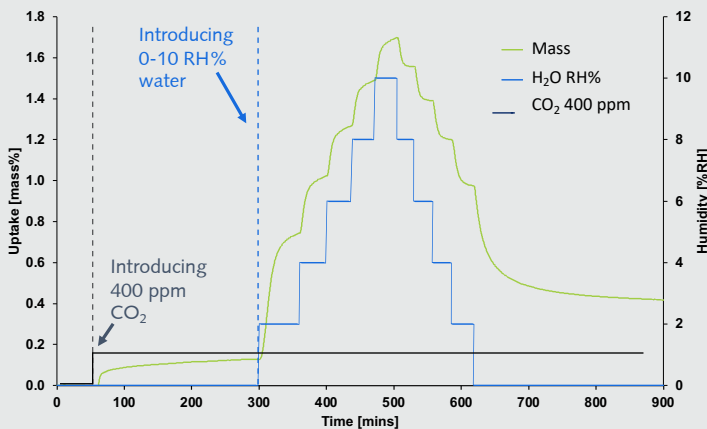

Figure 11: Evaluating total uptake in the presence of humidity and CO₂ on an amine functionalized sorbent

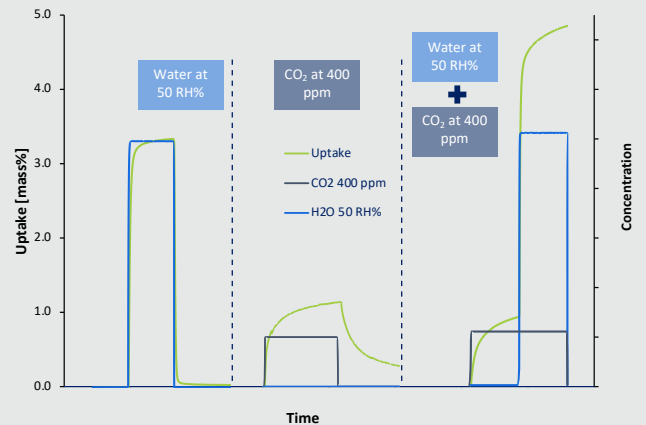

Figure 12: Sequential experiments evaluating kinetics of adsorption during step changes in humidity, 400 ppm CO₂ and both components



The DVS Carbon allows straightforward control of all important variables: CO₂ concentration, humidity, and temperature.

Modular Capabilities

Speed of Sound Sensor

The latest iteration of the SoS sensor is specially developed to enable control and precision in the generation and measurement of CO₂ concentrations, from high (100%) to low (0.5%) at 25 °C.



Speed of Sound Sensor

Heated Reservoir

- The heated reservoir is located in the temperature enclosure
- Designed for extended humidity generation up to 85°C, with fully automated temperature control
- Features a heated jacket to avoid evaporative cooling

High Temperature Preheater

(For drying and regeneration)

- *In-situ* degassing/activation of samples up to 300 °C
- The temperature is measured by a Pt-100 directly below the sample pan
- User programmable and controlled temperature ramps or steps



Optional:

Raman Spectroscopy

- Fully integrated hardware/software solution for triggering and capturing Raman spectra during sorption experiments

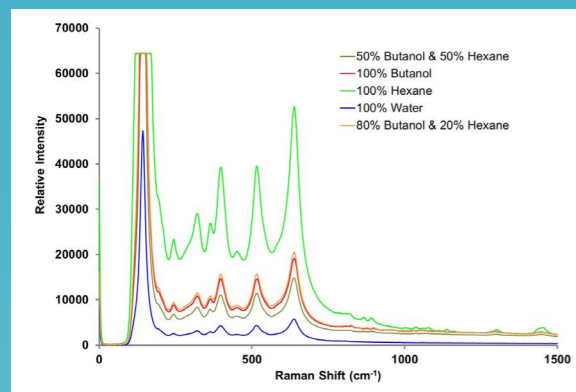

Figure 13. Raman spectra of single and dual-solvents sorption of butanol and hexane for a titanium oxide sample at 25 °C

Microscopy and Video

- 1.3 megapixel color camera and up to 200x optical zoom



Figure 14. In-situ monolith support



Raman probe observing samples during measurements

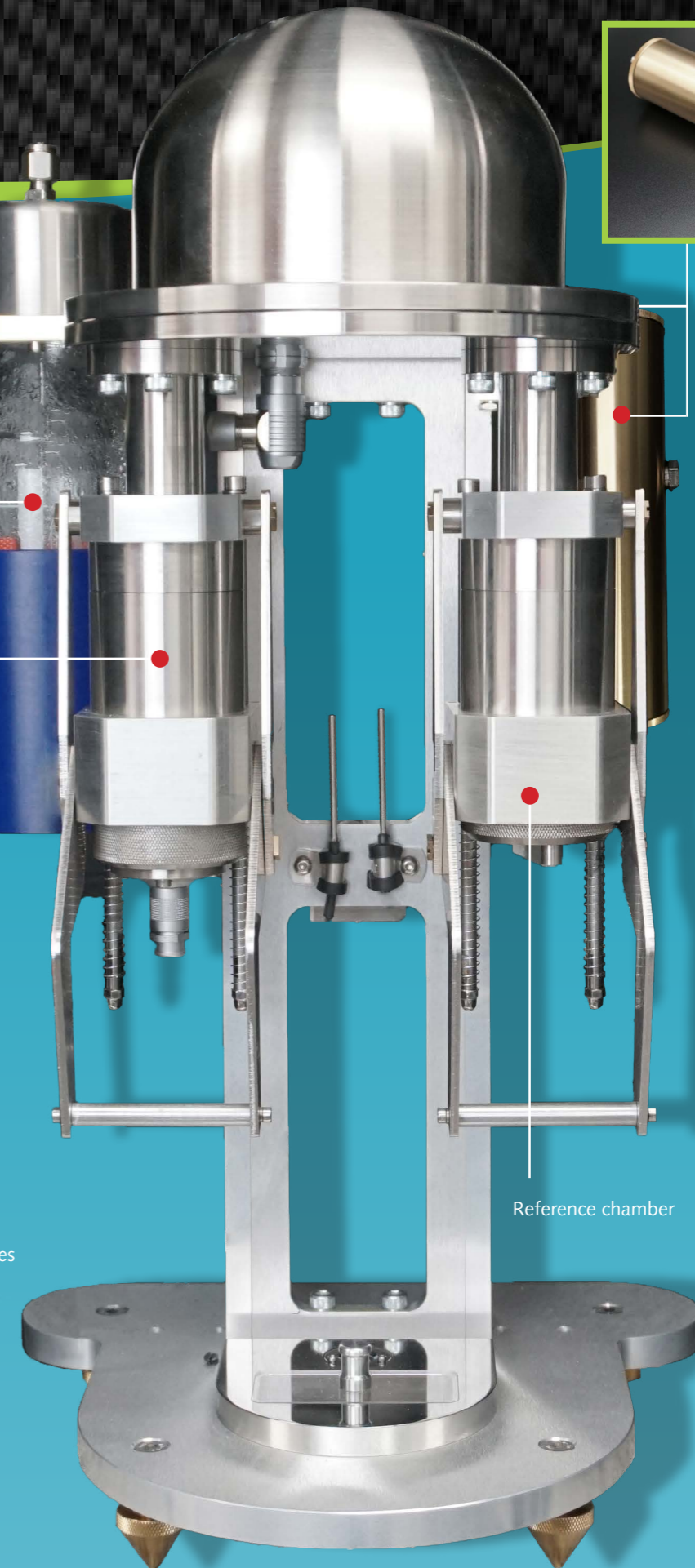

Reference chamber

Important: Camera and Raman cannot be used while the Preheater is mounted to the chamber

Purpose-built Software

The software package provided with the DVS Carbon allows the users to create and customize experimental methods while enabling the full analysis of the kinetic data collected. Examples of the control and analysis software used in two sorption experiments are outlined below.

Control Software

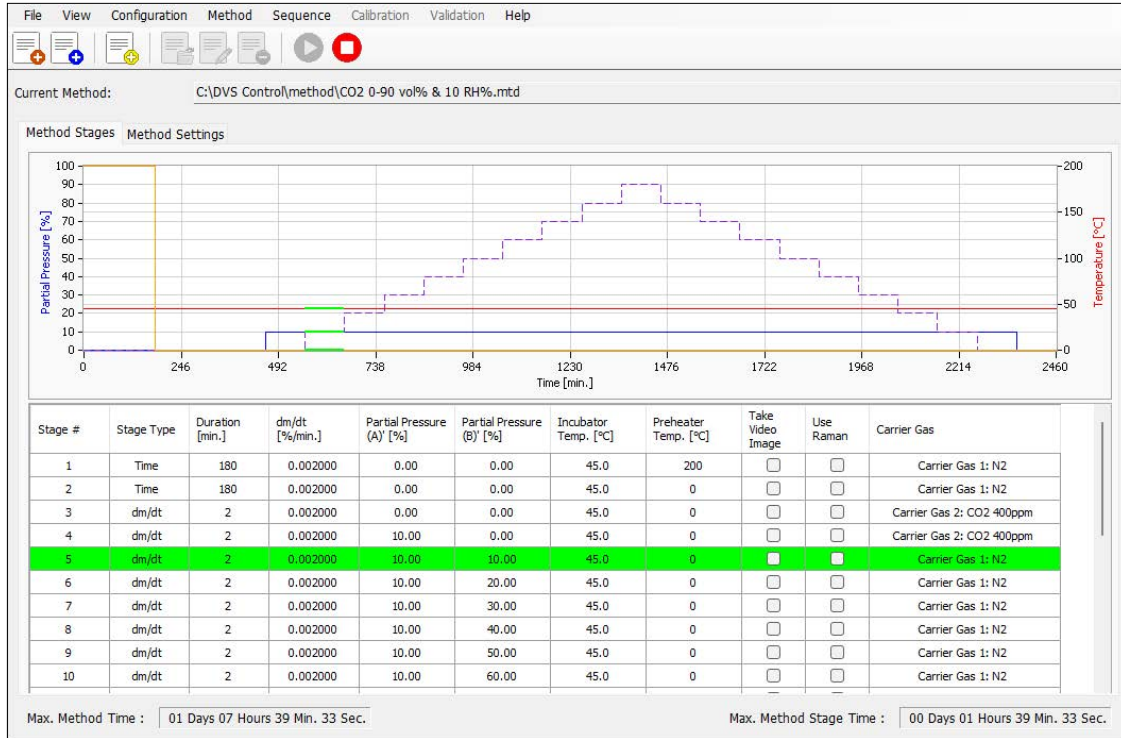

Figure 15. The above graph shows the method panel within the method manager. It displays numerically and graphically the current method for a water and CO₂ sorption experiment at 25 °C. The active stage of the ongoing experiment is highlighted in green. Figures 16 and 17 (below) are typical data generated by this method.

Analysis Software

Sorption Data

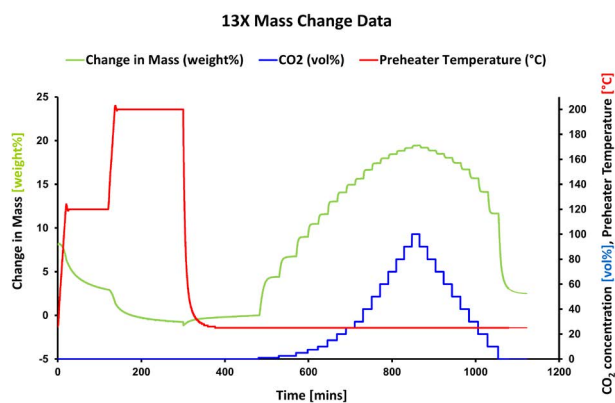

Figure 16. Sample activation and CO₂ sorption kinetics of zeolite 13X at 25 °C

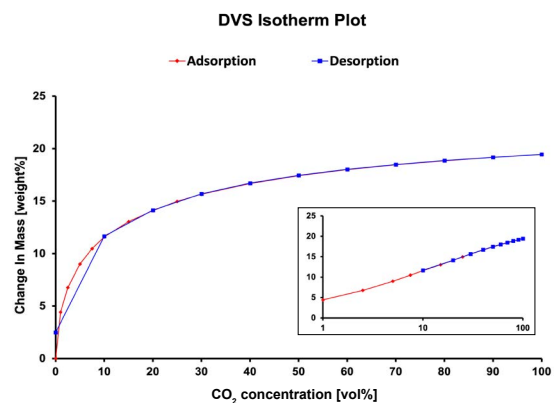

Figure 17. CO₂ sorption isotherm of zeolite 13X at 25 °C

Specifications

Construction Materials

Custom built manifold: 316 stainless steel
Seals: Viton® and Kalrez® or equivalent
Tubing: 1/4 inch 316 stainless steel

Gas Flow Control

High accuracy digital mass flow controllers
Wide dynamic range - turndown ratio 1000:1
Carrier gas: dry air, nitrogen, CO₂ (<1%) in nitrogen

Temperature Control

Temperature controlled enclosure

Contains entire generation and measurement system
Control range: 5 °C to 85 °C
Temperature stability ± 0.05 °C over 6 hours
Temperature resolution 0.01 °C

Local sample heater

Control range: up to 300 °C
Heating ramp rates: up to 10 °C/min

Humidity Generation & Measurement

Water Reservoirs

500 mL easy-change reservoir
Heated to avoid evaporative cooling

Generation

Relative humidity range

- 0 to 98% RH for 5-60 °C¹
- 0 to 85% RH for 60-85 °C¹

Relative humidity generation performance

- Accuracy: ±0.5% RH²
- Resolution: ±0.1% RH
- Stability: ±0.1% RH over 6 hours

Measurement

Relative humidity continuous measurement

- Range 0-100%RH

Relative humidity measurement accuracy

- ±0.8% RH at 5-40 °C
- ±1.5% RH at 40-85 °C

CO₂ Generation and Measurement

Generation

Concentration range 0-100% vol, atmospheric pressure

CO₂ generation performance

- Accuracy: exact³ or 0.5% vol of inlet concentration⁴

Measurement

Patented Speed of Sound Sensor

- Range: 0-100% vol⁵
- Accuracy: 0.1% vol up to 40% vol, 1% above

In line NDIR ppm sensor^{6,7}

- Range 0-3% vol
- Accuracy: 40 ppm⁵

Weight Measurement

Ultrabalance Low Mass

Maximum load: 1000 mg
Mass change: ±150 mg
Resolution: 0.01 µg
Balance noise: ≤ 0.3 µg⁸

Ultrabalance High Mass

Maximum load: 5000 mg
Mass change: ±1000 mg
Resolution: 0.1 µg
Balance noise: ≤ 3 µg⁸

Hardware Configuration

Standard

Mixing of two gas streams, with controlled humidity and CO₂ concentration, respectively⁹

Switching between different carrier gases e.g. Nitrogen and 400 ppm CO₂

Advanced

Two heated reservoirs for enhanced humidity generation at high CO₂ levels (up to 98% humidity in a pure CO₂ stream)⁹

Mixing and direct measurement of low CO₂ concentrations (ppm-level) through dedicated instrumentation⁹

System Information

Dimensions: 520 mm (W) x 980 mm (H) x 610 mm (D)

Weight: 80 kg (180 lb)

Electrical: 200-240 V, 50/60 Hz, 1500 VA

System Software

DVS Control Software

- Live data view and plotting
- Full control over all parameters
- Powerful custom methods and sequences
- Complex isotherm or isobar experiments
- Temperature changes in a single experiment
- Ramp or step methods available
- Intelligent (dm/dt) or time-based step equilibration criteria
- Multiple concentration or temperature cycles
- Automated video image or Raman spectra acquisition

DVS Analysis Software

- Automated isotherm calculation
- Full kinetics information during experiment
- Isotherm modeling
- Enthalpy (heat) of adsorption
- Permeability and diffusion modeling
- Surface area models

Software Options:

Standard (Included)

- Control software
- Standard analysis

Advanced (Optional)

- Advanced analysis suite
- Isotherm analysis suite

Footnotes

¹ Humidity factory calibrated at 25 °C and 70 °C. Calibrations at other temperatures upon request

² 1-σ confidence level with % RH based on SMS factory certified methods (Salt Calibration)

³ When using pure CO₂ or a calibrated cylinder

⁴ When mixing

⁵ At 25 °C

⁶ Only in advanced configuration

⁷ Using ppm probe reduces maximum operating T to 60 °C

⁸ Root mean square (averaged over 24 hours)

⁹ Some measurement restrictions apply

What is Dynamic Vapor Sorption?

Invented by Professor Daryl Williams, Founder & MD of Surface Measurement Systems, Dynamic Vapor Sorption (DVS) is a gravimetric sorption technique that measures how quickly and how much of a vapor or gas is sorbed by a sample. It does this by varying the vapor/gas concentration around the sample and measuring the resultant change in mass. DVS is a valued tool in R&D laboratories all over the world, from pharmaceutical, food, personal care and health to energy, aerospace, agriculture, environmental, and building material industries.

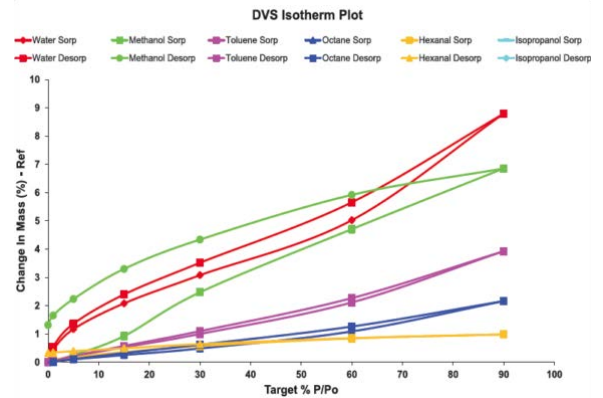

About Surface Measurement Systems

Surface Measurement Systems Ltd. develops and engineers innovative experimental techniques and instrumentation for physico-chemical characterization of complex solids, solving difficult problems in materials research. With over 30 years of continuous innovation, every instrument is built with the cumulative knowledge and experience of our world-leading team of sorption scientists. This makes us the preferred sorption partner of universities, research institutes, corporate R&D, and global government organizations, who we work with and support in pioneering the future of materials research.



sales@surfacemeasurementsystems.com • www.surfacemeasurementsystems.com

UK | USA | India | China | Germany