



ARES-G2 RHEOMETER

# The **ARES-G2** is the **MOST ADVANCED** rotational rheometer for **RESEARCH** and **MATERIAL DEVELOPMENT**



The ARES-G2 remains the only commercially available rheometer with a dedicated actuator for deformation control, Torque Rebalance Transducer (TRT), and Force Rebalance Transducer (FRT) for independent shear stress and normal stress measurements. It is recognized by the rheological community as the industry standard to which all other rheometer measurements are compared for accuracy. The ARES-G2 platform offers an array of incomparable features including:

- Unrivaled data accuracy
- Unmatched strain and new stress control
- Fully integrated fast data sampling
- Separate electronics
- New Smart Swap™ environmental systems
- Patented Active Temperature Control
- Advanced accessories
- TRIOS Software providing extreme testing flexibility
- Large Amplitude Oscillatory Shear (LAOS) and Fourier Transform (FT) Rheology Analysis Software package
- NEW Orthogonal Superposition (OSP) and 2 Dimensional Small Amplitude Oscillatory Shear (2D-SAOS) techniques
- NEW DMA mode for measurements of solids in bending, tension and compression

**There simply is no comparison to any other rheometer.**

## RHEOLOGY AND RHEOMETRY | THEORY

Rheology is the study of flow and deformation of materials. Deformation and flow are referred to as strain or strain rate, respectively, and indicate the distance over which a body moves under the influence of an external force, or stress. For this reason, rheology is also considered to be the study of stress-strain relationships in materials.

A rheometer is a precision instrument that contains the material of interest in a geometric configuration, controls the environment around it, and applies and measures wide ranges of stress, strain, and strain rate.

Material responses to stress and strain vary from purely viscous to purely elastic to a combination of viscous and elastic behavior, known as viscoelasticity. These behaviors are quantified in material properties such as modulus, viscosity, and elasticity.

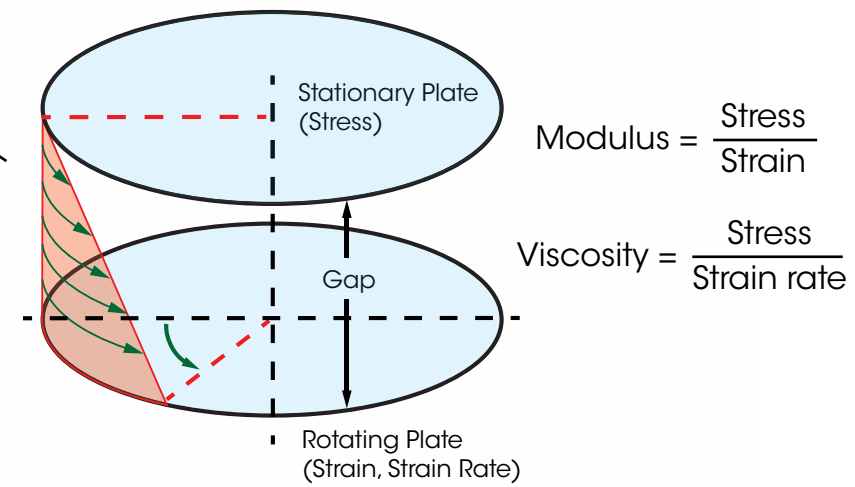

### The benefits of rheology

Most industrially relevant materials exhibit complex rheological behavior. These properties determine a material's processability and end-use performance. This means that rheological measurements are critical to a wide range of industries including aerospace, asphalt, automotive, ceramics, elastomers, electronics, food, personal care, biomedical, paints and coatings, inks, petroleum products, pharmaceuticals, and more. A rheometer can be used to measure and understand how rheological properties influence every stage of industrial production.

**Formulation:** Measure and predict the consequences of formulations based on chemistry, concentration, and phase structure. Study existing materials and understand formulation based on rheological properties.

**Processing:** Choose formulations and processes that save time, power, and preserve desired finished properties.

**Performance Prediction:** Make *a priori* predictions of material performance based on known use conditions without specifically mimicking application conditions.

**Consumer Acceptance:** Quantitatively optimize properties that customers perceive as valuable based on consistency, texture, mouth feel, behavior at chewing and swallowing, applicability, spreading, pourability, and stability during storage.





## ARES-G2 | TECHNOLOGY

### The ARES-G2 provides independent measurements of stress and strain

The ARES-G2 is the only Separate Motor and Transducer (SMT) rheometer in the world. An SMT is more than two drives. It is a separate motor and transducer optimized for every aspect of rheological measurement. A motor designed for perfect deformation. A transducer optimized for exacting stress measurements. The result is the **purest rheological measurements, free of instrument artefacts over the widest ranges of stress, strain and frequency.**

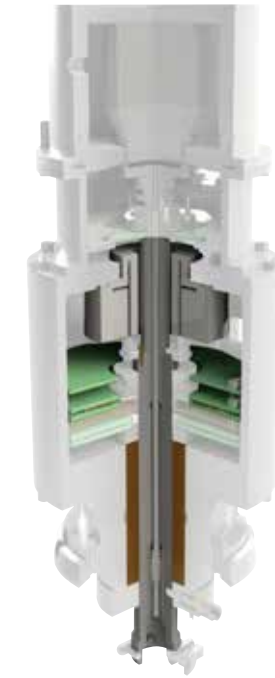
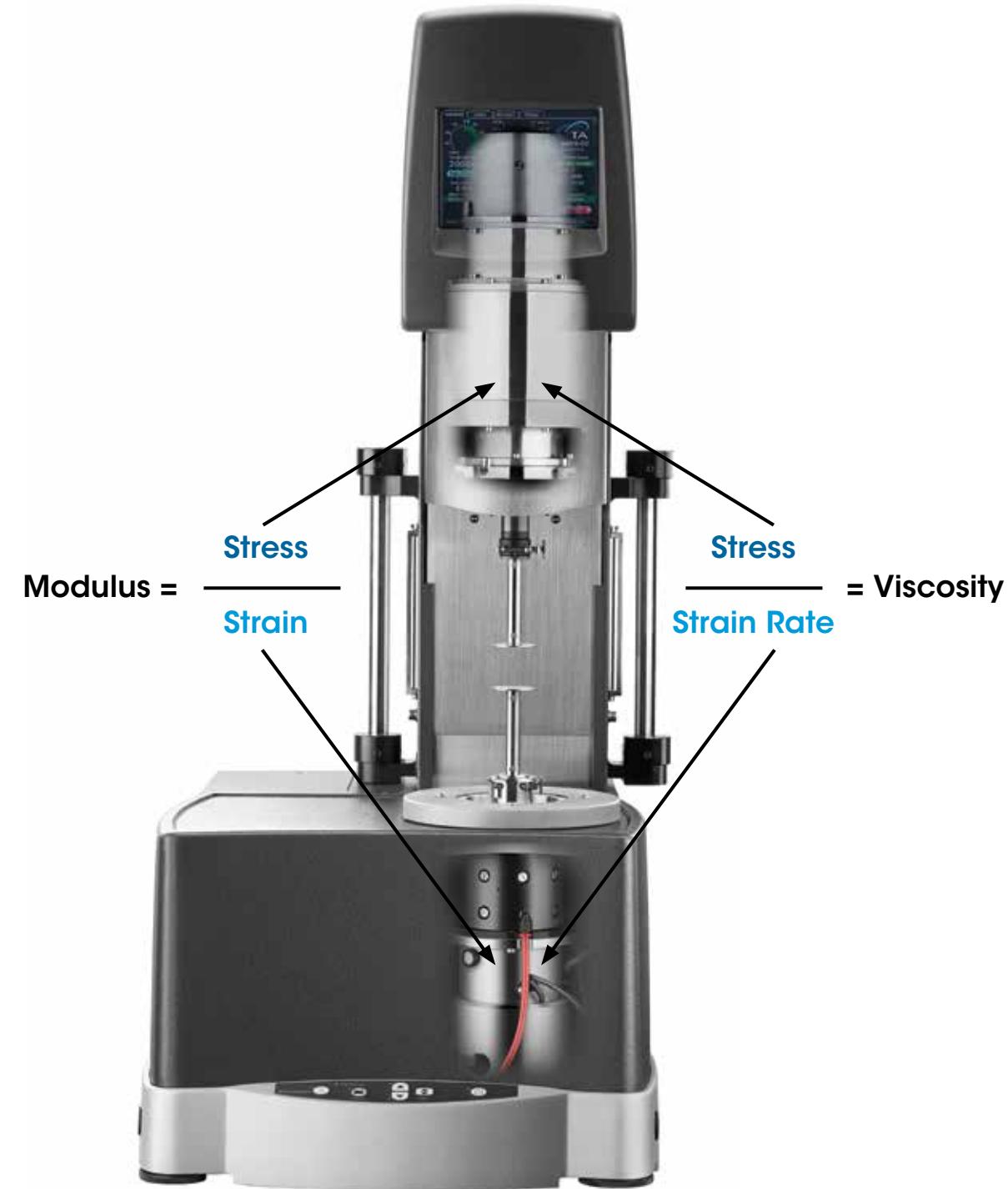

#### Torque Rebalance Transducer (TRT)

The ARES-G2 Torque Rebalance Transducer (TRT) is the third generation of rebalance transducers designed and optimized exclusively for the most exacting measurements of sample stress. This active system employs patented technology to measure the most accurate sample stress based on the torque required to maintain a null position. The ARES-G2 TRT is free from instrument inertial corrections and errors, and is designed and optimized exclusively for this task. This quasi-infinitely stiff transducer features a dynamic torque range of 5,000,000 to 1, a robust air bearing, a high resolution capacitive angle sensor (Patent # 7,075,317 and 7,135,874), and new non-contact upper temperature sensor (Patent # 6,931,915). The independent and stationary torque measurement eliminates the need to correct for motor friction and inertia, which translates to the purest torque measurement available.



#### Normal Force Rebalance Transducer (FRT)

Unmatched normal force measurements are achieved with the ARES-G2 Force Rebalance Transducer (FRT). It consists of an axial servo control system that utilizes position feedback to maintain the FRT shaft in a null position. It delivers the most accurate and fastest transient normal force measurements with unmatched transducer stiffness.



#### Drive Motor

The ARES-G2 direct drive motor is designed and optimized to deliver the most accurate rotational motion over wide ranges of angular displacement and velocity. Key components of the design include a rigid air bearing system, an 800 mN.m high-torque friction-free brushless DC motor, patented non-contact temperature sensing, and an optical encoder displacement sensor. Designed exclusively for sample deformation, the ARES-G2 motor is characterized by the highest stiffness, best concentricity, and lowest axial run-out, for superior shear and normal stress measurements.

## ARES-G2 | TECHNOLOGY

### Active Temperature Control (ATC)

The ARES-G2 incorporates patented non-contact temperature sensor technology for active measurement and control of both the upper and lower plate temperature (Patent # 6,931,915). Platinum Resistance Thermometers (PRTs) are positioned in intimate contact with the center of the lower and upper measurement surfaces and transmit temperature readings to the instrument wirelessly. These temperature readings enable direct control of both plate temperatures and result in more accurate and responsive temperature control, no vertical temperature gradients and **no need for complex calibration procedures and offset tables** to infer sample temperatures. This is far superior to competitive devices that rely on air temperature measurements alone, which are prone to thermal lag and offset.

To illustrate the benefits of this novel technology, an asphalt sample was held at 25 °C for five minutes before the temperature was stepped to 85 °C. The material's complex viscosity was monitored in the two successive oscillation time sweep tests. Two temperature control configurations were used: one with the two PRTs in physical contact with the plates using ATC technology and a second with a PRT in close proximity to the plates but not physically contacting them. The data from the second case show an apparent rapid increase in sample temperature to 85 °C but a slow response from the sample's complex viscosity before it reaches a steady state value. This shows that the real sample temperature is very different from the reported temperature. However, the data from the configuration using the ATC technology show the actual plates' temperature rise tracking exactly the decrease in the material's complex viscosity. Only with Active Temperature Control is the sample temperature measured so accurately.

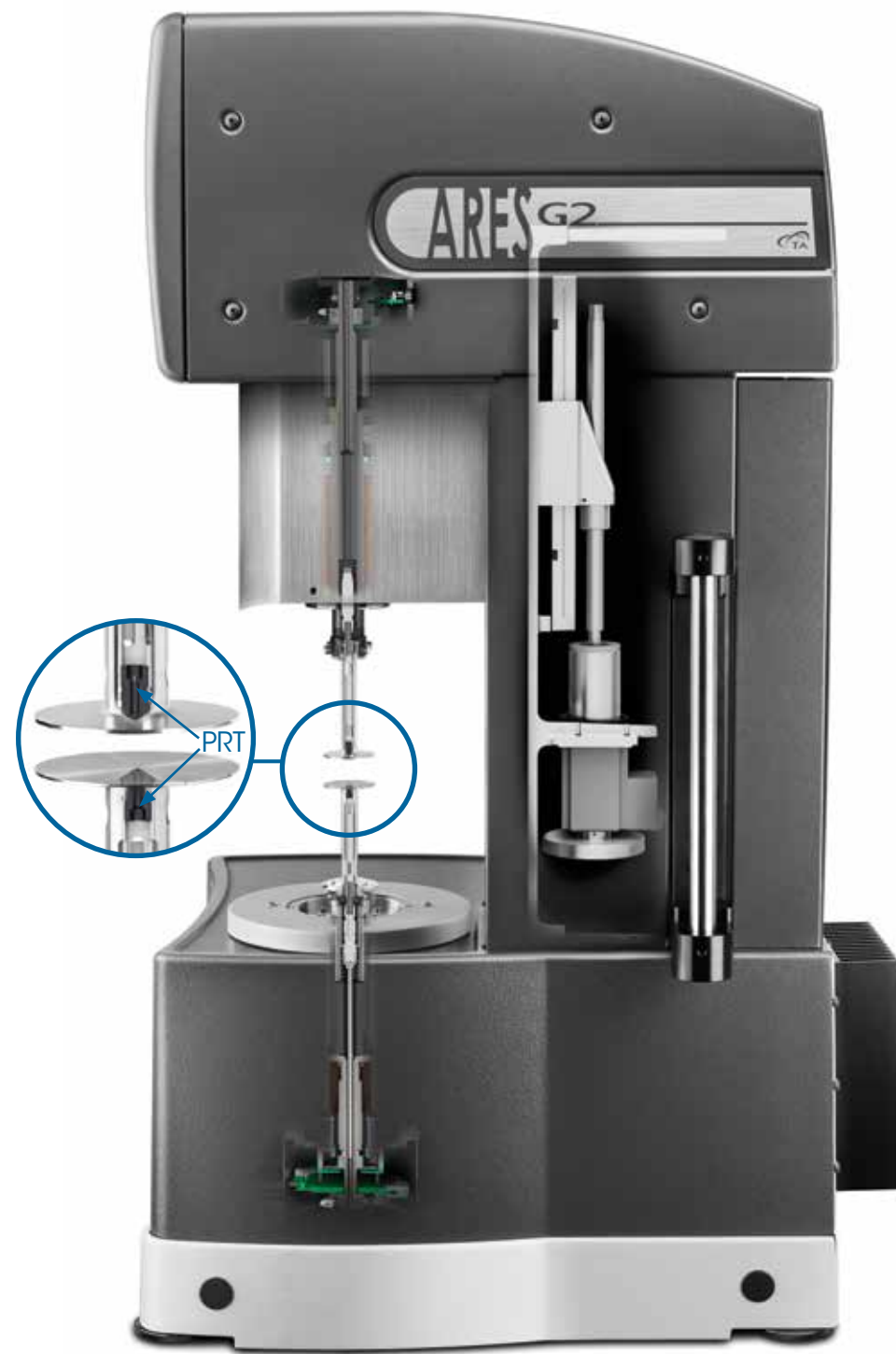

### Touch-Screen and Keypad

This graphical interface adds a new dimension in ease-of-use. Interactive activities such as geometry zeroing, sample loading, and setting temperature can be performed at the test station. Important instrument status and test information such as temperature, gap, force and motor position are displayed. The touch-screen also provides easy access to instrument settings and diagnostic reporting. A keypad at the base of the instrument allows for easy positioning of the measurement head.

### Frame, Vertical Movement and Alignment

The ARES-G2 frame and vertical movement assembly is built to deliver maximum stiffness, low axial compliance (0.1  $\mu\text{m}/\text{N}$ ), and the most accurate geometry positioning, concentricity, and alignment.

**The frame** provides high strength, optimum damping for high frequency testing, and dimensional stability over a wide temperature range.

**The transducer mount** is held rigidly against the frame by two hardened steel cross roller slides. The slides deliver smooth vertical movement of the head while maintaining concentricity and parallelism. This is critical when setting a gap in parallel plates.

**The transducer head** is positioned vertically via a precision ground lead screw. It is attached to a micro-stepping motor by a rigid, preloaded, duplex bearing, which eliminates backlash.

**A linear optical encoder** is mounted directly between the stationary frame and moving bracket for precision head positioning, independent of the lead screw movement, to an accuracy of 0.1  $\mu\text{m}$ .

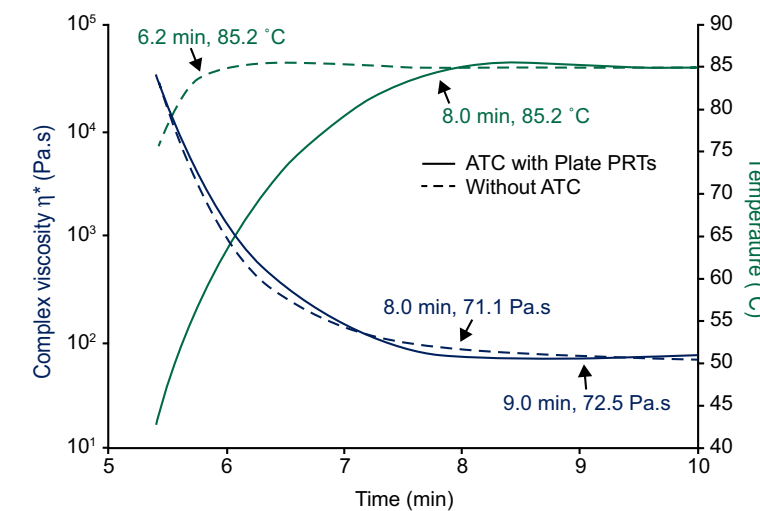

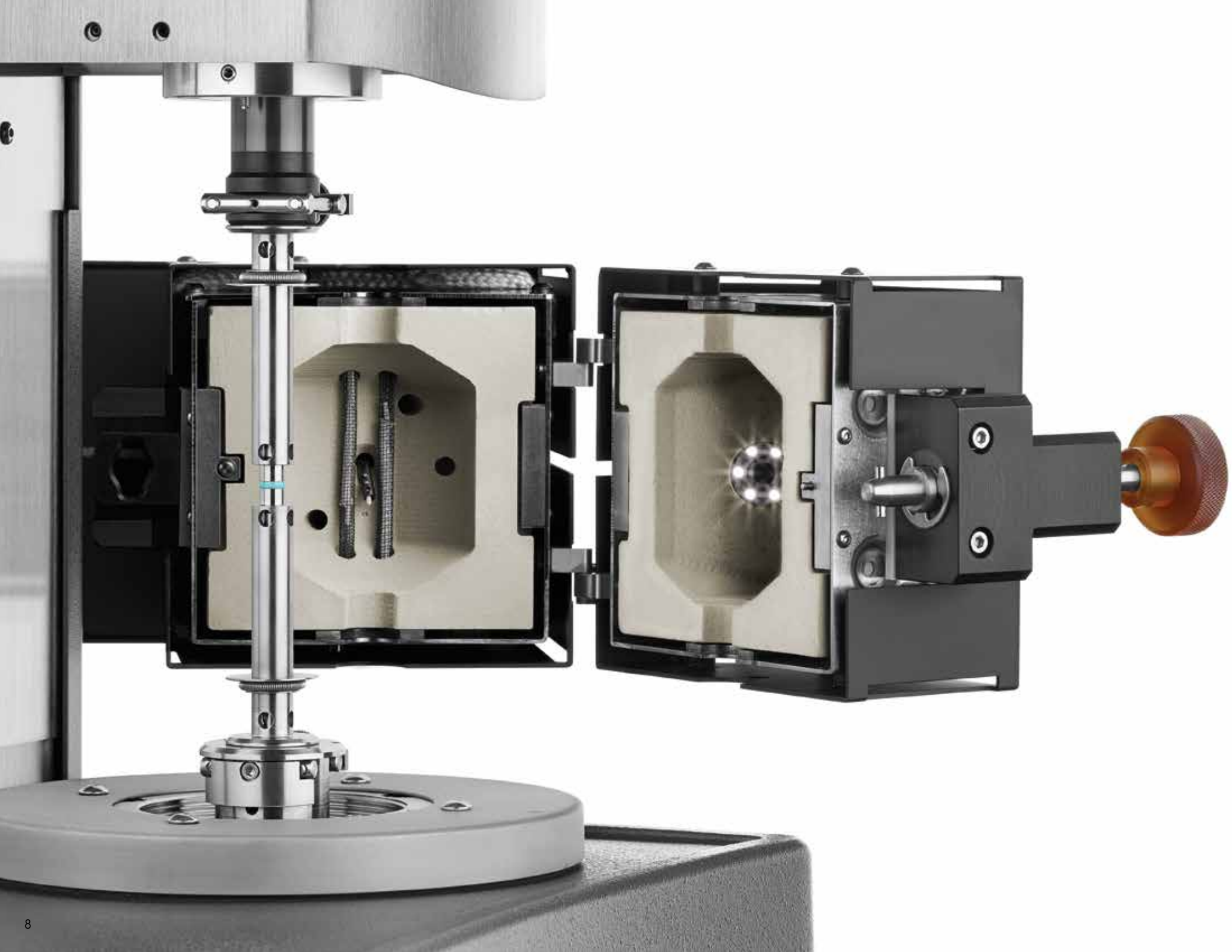

## FORCED CONVECTION OVEN | ENVIRONMENTAL ACCESSORY

### Forced Convection Oven (FCO)

The FCO is the premier temperature device for polymers and thermosets, featuring the fastest temperature response, extreme oxygen exclusion and unrivaled thermal uniformity. This gas-convection oven is designed for optimum temperature stability, extremely rapid heating and cooling, and ease-of-use over the temperature range of -150 °C to 600 °C. This powerful heating mechanism can heat at controlled rates up to 60 °C/min. An available liquid nitrogen cooling system is employed to achieve rapid, uniform and efficient cooling to temperatures as low as -150 °C. Alternatively, mechanical chiller systems can also be used to cool as low as -100 °C without the need for liquid nitrogen. The FCO is used primarily for testing polymer melts, thermosetting materials and solid specimens, and provides exceptional exclusion of oxygen, making it an effective option for high temperature testing of polymers with poor oxidative stability. Superior temperature stability and uniformity is achieved through the use of twin element heaters, which produce counter-rotating airflow in the oven chamber to heat the sample quickly and without thermal gradients.

The FCO can be mounted on either side of the test station and comes standard with a long-life internal LED lamp and window viewing port. An optional camera viewer can be used to record real-time sample images throughout experiments. This visual record is helpful for data validation and sample condition verification. A range of geometries are available for the FCO, including parallel plate, cone and plate, solid torsion, cone and partitioned plate (CPP), extensional viscosity fixture (EVF), the SER3-A Universal Testing Platform and a new range of linear DMA clamps.

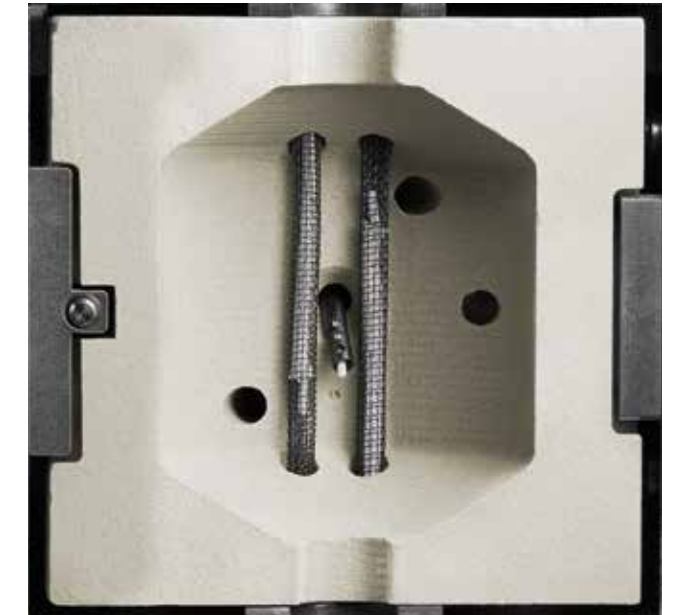

The Forced Convection Oven is designed to **optimize temperature response time, uniformity and stability**. Gas is passed over two resistive gun heaters and into the specially shaped oven cavity which optimizes gas mixing and uniformity. Up to five thermocouples within the oven make continuous measurements of temperature and are used to determine what power and gas flow should be commanded to each heating gun to maintain the ideal thermal environment.



## FORCED CONVECTION OVEN | SAMPLE GEOMETRIES



### Parallel Plates and Cone and Plates

FCO plate geometries are available in 8, 25, 40 and 50 mm diameters and a range of materials of construction such as stainless steel or titanium. Upper cone geometries are readily available in 0.02, 0.04, and 0.1 radian cone angles. By changing the diameter and cone angle, the measurement range of stress and strain or shear rate can be varied to capture the widest range of test conditions. For curing systems, disposable plates and cones are available in 8, 25, 40, and 50 mm diameters. Low viscosity thermoset resins can be tested with lower disposable cups or plates with drip channels to prevent loss of sample.

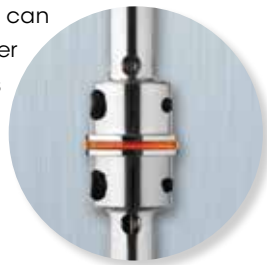

### Solid Torsion

Solid or rubbery materials can be characterized using the Rectangular or Cylindrical Torsion geometries. This mode of testing is especially valuable for measuring fully cured thermosets and composites, or measuring the glass transition and secondary transitions of thermoplastic polymers. These stiffer samples are clamped with their long axis coaxial with the rheometer's rotational axis. Rectangular samples can vary between 0.3 to 6 mm in thickness, up to 12 mm in width, and 40 mm in length. Cylindrical samples with diameters of 1.5, 3, and 4.5 mm can be accommodated with the Cylindrical Torsion geometry.



### Extensional Viscosity Fixture (EVF)

The EVF is a patented (Patent # 7,096,728 B2) system used to measure the extensional viscosity of highly viscous materials such as polymer melts, dough, adhesives and more. The fixture utilizes one fixed drum, and another that rotates and revolves around the fixed drum, creating constant rate uniaxial extension in the sample. The extensional stress is measured by the fixed drum which is unimpeded by any gears or bearings, providing the most accurate stress measurement possible and not requiring any calibration for bearing friction. Hencky strains up to 4.0 can be applied and the FCO controls test temperatures as high as 350 °C.



### SER3 Universal Testing Platform

The SER3 Universal Testing Platform is used to perform extensional viscosity measurements and a range of additional material tests. Samples are secured to the surfaces of two windup drums which counter-rotate at equal speeds thanks to a system of intermeshing gears. At a constant drum rotation speed, a constant Hencky strain rate is applied to the sample. The sample stress that resists this deformation is measured by the torque transducer, allowing for the measurement of extensional viscosity. The frame of reference of the SER3 is fixed, making it well-suited to sample imaging and optical analysis during deformation. In addition to extensional viscosity measurements on polymer melts, the SER3 is capable of a range of physical property measurements such as tensile, peel, tear and friction testing on hard and soft solid samples.

### Cone and Partitioned Plate Accessory

The new ARES-G2 Cone and Partitioned Plate Accessory (CPP) expands testing capabilities for highly elastic materials at large deformations in both oscillation and steady shear. The CPP geometry is a conventional cone-plate test configuration in which only the central portion of the plate is coupled to the stress measurement. This creates a "guard ring" of sample around the active measurement area, delaying the effects of edge failure, allowing for higher strains to be measured on elastic materials. This material guard ring also reduces the importance of sample trimming, improving data reproducibility and reducing operator-dependence. The geometry consists of a 25 mm annular plate with a hollow shaft which is affixed to the transducer mount. A 10 mm central plate is located within the annulus and is the active measurement surface attached to the torque/normal force transducers. The lower geometry is a 25 mm 0.1 rad cone. The CPP requires minimal alignment and can be easily removed for cleaning. The CPP is unique to the ARES-G2 and further extends its advantages for LAOS testing and polymer rheology.



CPP Upper



CPP Lower



## ADVANCED PELTIER SYSTEM | ENVIRONMENTAL ACCESSORY

### Advanced Peltier System (APS)

The APS is a Smart Swap™ Peltier temperature control environmental system that allows for maximum flexibility in test geometry over the temperature range of -10 °C to 150 °C. The system provides controlled heating rates up to 20 °C/min and accuracy within ±0.1 °C. Unlike other Peltier temperature systems, the APS features both plate (parallel plate and cone-plate) and DIN-conforming concentric cylinder geometries. The new quick-change lower plate system includes a 60 mm diameter hardened chromium surface and a unique bayonet fixture that allows the user to **quickly and easily change plate surfaces** based on diameter, material, and surface texture. The APS also features an efficient heated solvent trap cover for blocking evaporation during the testing of volatile materials.

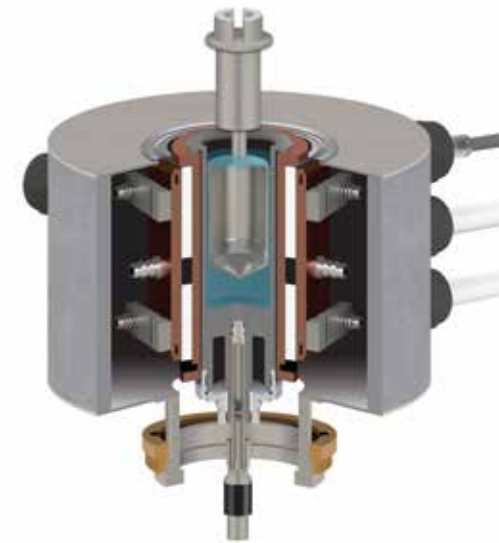

The APS controls temperature through a non-contact heat transfer mechanism. A 50 µm gap between the Peltier elements and the system core allows for the most pure sample deformation while allowing efficient heat transfer across the thin gap.

### Geometry Types

Several upper geometry types are available based on the needs of the test at hand. Heat break collars reduce heat transfer and improve temperature uniformity while maintaining the ruggedness and chemical resistance of a stainless steel plate. Low expansion and low thermal conductivity polyphenyl sulfone (PPS) plates further improve temperature uniformity.



Stainless Steel with Solvent Trap



Stainless Steel with Heat Break and Solvent Trap



PPS with Solvent Trap

### Plate Surface Textures

Both upper geometries and lower quick change plates are available with a range of surface textures. Roughened surfaces effectively eliminate slip, an artefact which can occur with many materials, particularly filled systems.



Smooth



Sandblasted

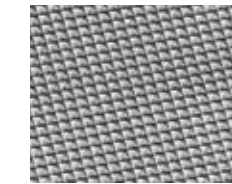

Crosshatched



Serrated

### Quick Change Plates

The APS features a Quick Change Plate system that allows several lower plate covers to be easily attached using a simple bayonet-style locking ring. These plates can be selected based on material, diameter, and surface finish. Disposable plates are also available for curing materials.



8 mm Stainless Steel



20 mm Disposable Aluminum



25 mm Crosshatched Aluminum



40 mm Anodized Aluminum



40 mm Sandblasted



50 mm Titanium





**Peltier Solvent Trap and Evaporation Blocker**

The Solvent Trap cover and Solvent Trap geometry work in concert to create a thermally stable vapor barrier, virtually eliminating solvent loss during the experiment. The geometry includes a reservoir that is filled with a very low viscosity oil or the volatile solvent present in the sample. The Solvent Trap cover includes a blade that is placed into the solvent contained in the well without touching any other part of the upper geometry. A uniform temperature, saturated vapor, environment is established, preventing loss from the sample and condensation from the cover. The Solvent Trap sits directly on a centering ring at the top of the APS surface for easy positioning.



**Immersion Cup**

The APS Immersion Cup allows samples to be measured while fully immersed in a fluid. It attaches easily to the top of the APS Plate with the bayonet fixture. A rubber ring provides the fluid seal and allows for easy sample loading, trimming, and subsequent sealing and filling. The Immersion Cup system can accommodate plates or cones up to 40 mm in diameter. This accessory is ideal for studying the properties of hydrogels.



**Cup and Bob Geometries**

Available APS geometries include cups of 10, 15 and 17 mm radius, configured with either a Recessed End or DIN Bob. The bobs have 9.3, 14 and 16 mm radii and, when used in conjunction with the corresponding cups, adhere to the DIN standards. The double gap concentric cylinder has an additional shearing surface over single gap providing lower stress and higher sensitivity for extremely low viscosity solutions.

**Special Cups and Bobs**

Specialty geometries include vanes and helical bobs. These special concentric cylinder geometries are very valuable for characterizing dispersions with limited stability, preventing error from slip at the material/geometry interface, and for bulk materials with larger particulates. Vane geometries are available in both 7.5 mm and 14 mm radii. The helical bob can be configured with the large cup to keep a sample mixed or particles suspended during shearing.

Cup	Bob					
	DIN	Recessed	Vane	Wide Gap Vane	Helical	Double Gap
10 mm radius	•	•		•		
15 mm radius	•	•	•	•		
17 mm radius		•	•	•	•	
Double Gap						•

## Oscillation Testing

The state-of-the-art Separate Motor and Transducer (SMT) design of the ARES-G2 provides the highest quality of oscillatory data under the widest range of material types and test conditions. Oscillation testing is by far the most common test type for measuring viscoelastic properties of materials. Both elastic and viscous characteristics of the material can be studied by imposing a sinusoidal strain (or stress) and measuring the resultant sinusoidal stress (or strain) along with the phase difference between the two sinusoidal waves (input and output). The phase angle is zero degrees for purely elastic materials (stress and strain are in phase) and 90° for purely viscous materials (stress and strain are out of phase). Viscoelastic materials exhibit a phase angle anywhere between these two ideal cases depending on the rate of deformation. The figures below show these sinusoidal responses along with the variety of rheological parameters obtained. The viscoelastic parameters can be measured as a function of deformation amplitude, frequency, time, and temperature.

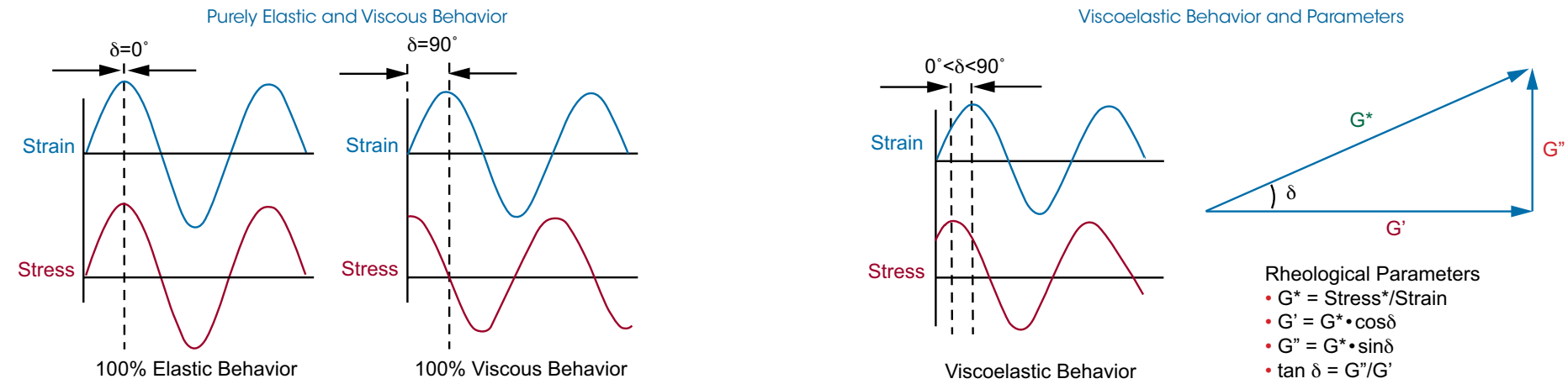

## Oscillation Frequency Sweep

The temperature and strain are held constant in a frequency sweep and the viscoelastic properties are monitored as the frequency is varied. The figure below illustrates a viscoelastic fingerprint for a linear homopolymer and shows the variation of  $G'$  and  $G''$  as a function of frequency. As frequency is the inverse of time, the curve shows the time-dependent mechanical response, with short times (high frequency) corresponding to solid-like behavior and long times (low frequency) to liquid-like behavior. The magnitude and shape of the  $G'$  and  $G''$  curves depend on the molecular structure. Frequency sweeps are typically run over a limited range of 0.1 to 100 rad/s. Time-temperature superposition (TTS) is often used to extend the frequency range by running a series of frequency sweeps at several temperatures. The data shown comprise a master curve constructed at a reference temperature of 190 °C for polystyrene. The original frequency range of three decades was extended to about 8 decades by using TTS.

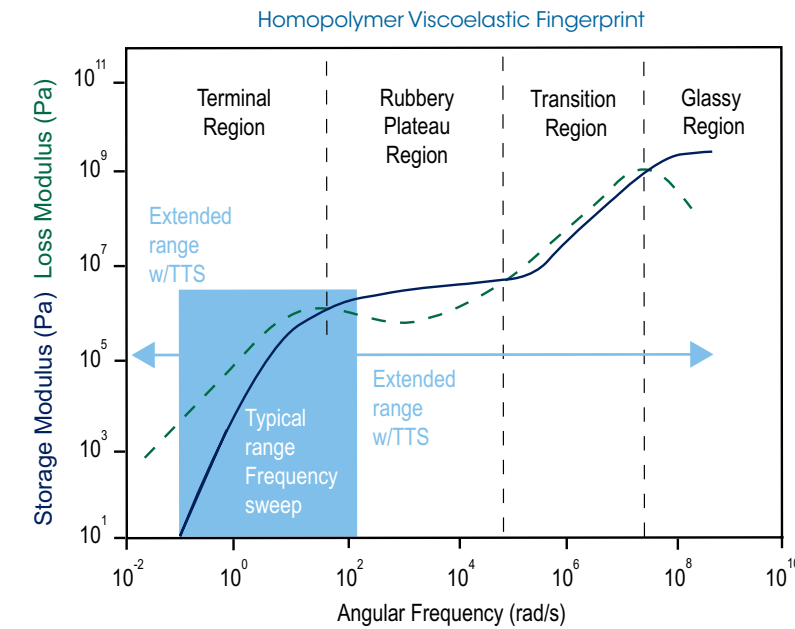

## Oscillation Strain Sweep

In this test, the frequency and temperature are held constant and the viscoelastic properties are monitored as the strain is varied. Strain Sweep tests are used to identify the linear viscoelastic region, LVR. Testing within the LVR provides powerful structure-property relationships as a material's molecular arrangements are never far from equilibrium and the response is a reflection of internal dynamic processes. The data shown are for a strain sweep on polyisobutylene solution (SRM 2490) in cone and plate geometry. At low strains, within the LVR, the modulus is independent of the strain amplitude up to a critical strain  $\gamma_c$ . Beyond the critical strain the behavior is non-linear and the modulus begins to decrease in magnitude showing the end of the LVR for this material. In addition to the viscoelastic properties, the ARES-G2 can collect higher harmonic information.

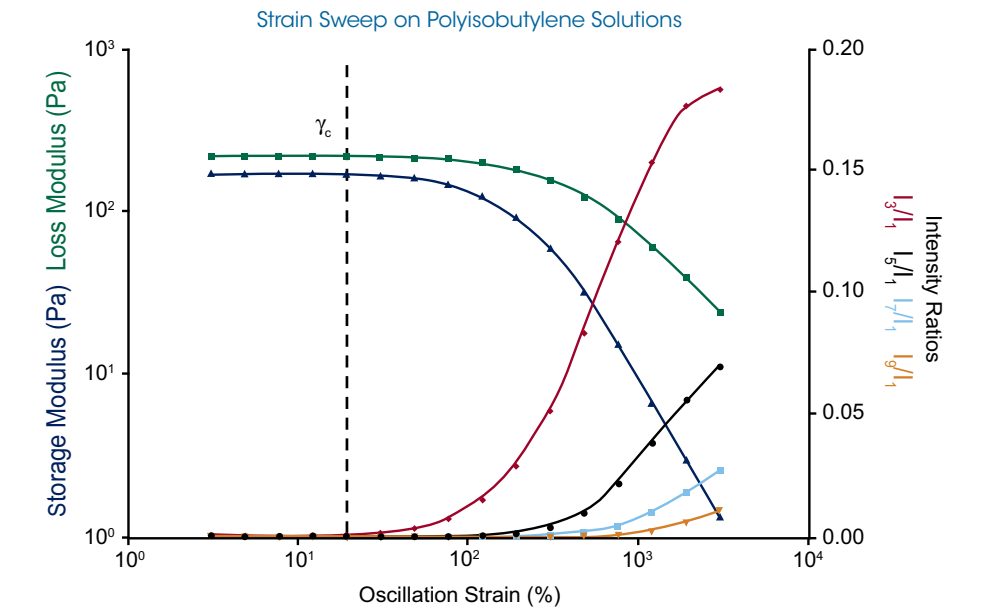

## Oscillation Temperature Ramp and Sweep

Measuring the viscoelastic properties over a range of temperatures is an extremely sensitive technique for measuring the  $\alpha$  or glass transition temperature,  $T_g$ , as well as any additional  $\beta$  or  $\gamma$  transitions of a material. In a temperature ramp, a linear heating rate is applied. Typical heating rates are on the order of 1 to 5 °C/min. The material response is monitored at one or more frequencies, at constant amplitude within the LVR. Data are taken at user-defined time intervals. A temperature ramp on polycarbonate performed with the torsion rectangular geometry is shown below. Multiple parameters can be used to determine transitions including  $G'$  onset point or peaks in the  $G''$  or  $\tan \delta$ .

In a temperature sweep, a step-and-hold temperature profile is applied. At each temperature of the sweep, the sample is "soaked" or equilibrated for a user-defined amount of time to ensure temperature uniformity in the material. The material response is then measured at one or many frequencies at constant amplitude within the LVR. This is the method of choice for time-temperature superposition studies as all the frequency-dependent data are collected at the same temperature. This data can be used with the Rheology Polymer Library software for the calculation of molecular weight distribution of polymers.

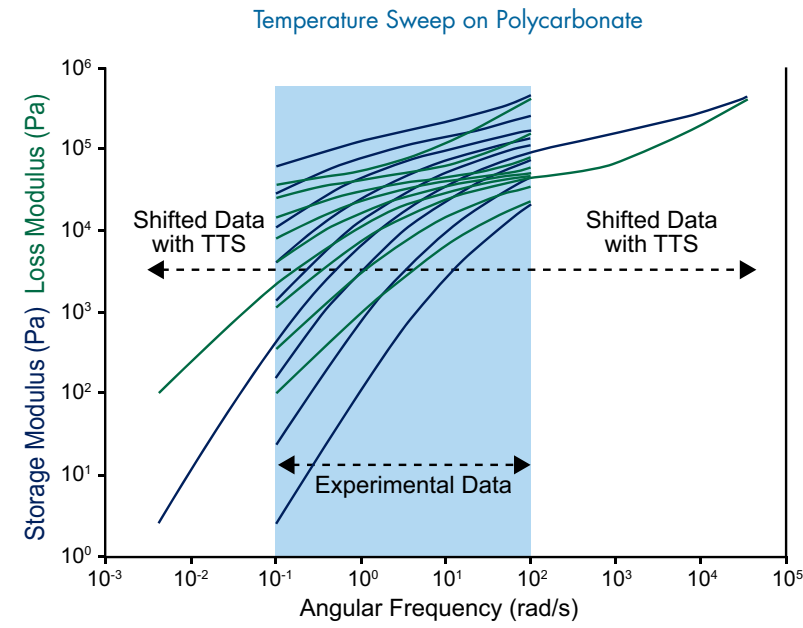
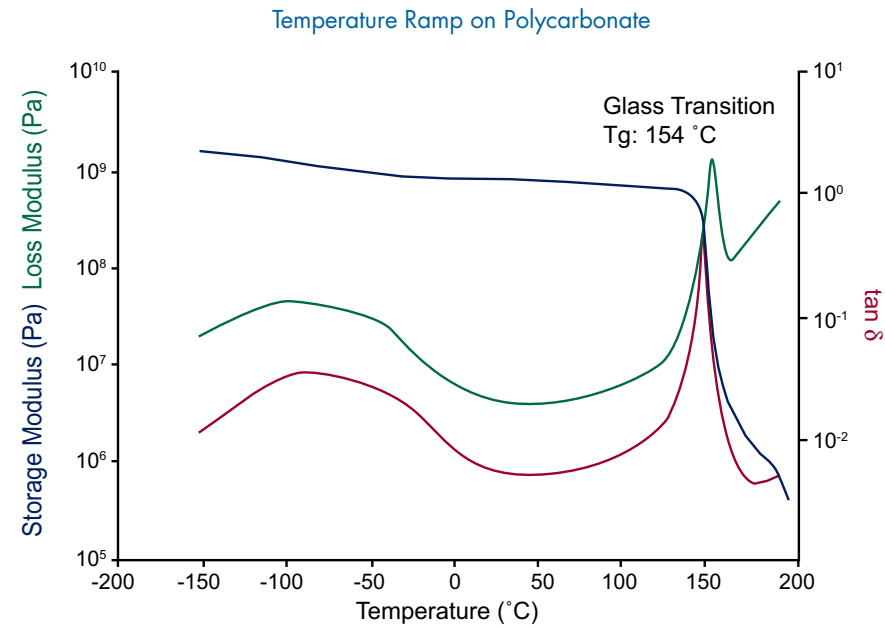

## Oscillation Time Sweep

While holding temperature, strain, and frequency constant, the viscoelastic properties of a material are measured as a function of time. Oscillation time sweeps are important for tracking how material structure changes with time. This is used for monitoring a curing reaction, fatigue studies, structure rebuild, and other time-dependent investigations. Data are shown for a two-part 5-minute epoxy cured using disposable parallel plate geometry. At short times the storage modulus is lower than the loss modulus. As the curing reaction progresses, the two moduli cross at the gel point, beyond which  $G'$  becomes larger than  $G''$  and the material hardens.

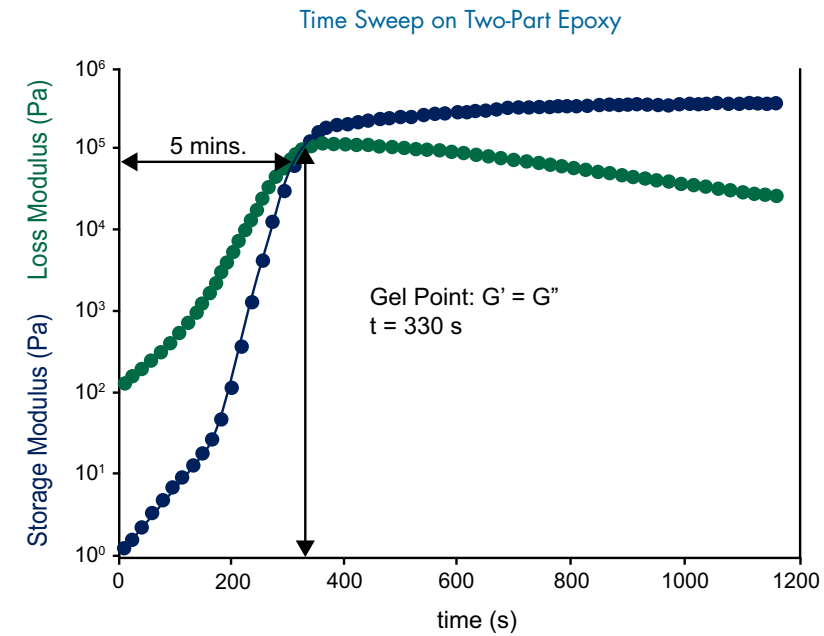



# FLOW AND TRANSIENT | TESTING MODES & APPLICATIONS

## Flow Testing

Flow tests are used to measure a material's "resistance to flow" or viscosity profiles. It is important to note that most materials are non-Newtonian, i.e. their viscosity depends on the rate of deformation. For these materials the viscosity is not a single point value, but is represented by a range of values or a curve that can vary many orders of magnitude over a wide range of shear rates. In the Flow mode, the rheometer applies a wide range of shear rate (or stress) to the sample in a stepped or continuous fashion, and the resultant shear stress (or rate) is measured. The calculated apparent viscosity is typically plotted as a function of the control variable and this curve is referred to as a flow curve. Generalized flow curves for dispersions and polymers are shown below.

## Fluids

The data generated provides information on apparent viscosity, yield stress, shear thinning, thixotropy, and correlates to real world processes. Simple techniques like spindle viscometers can only measure a point or small part of the total curve.

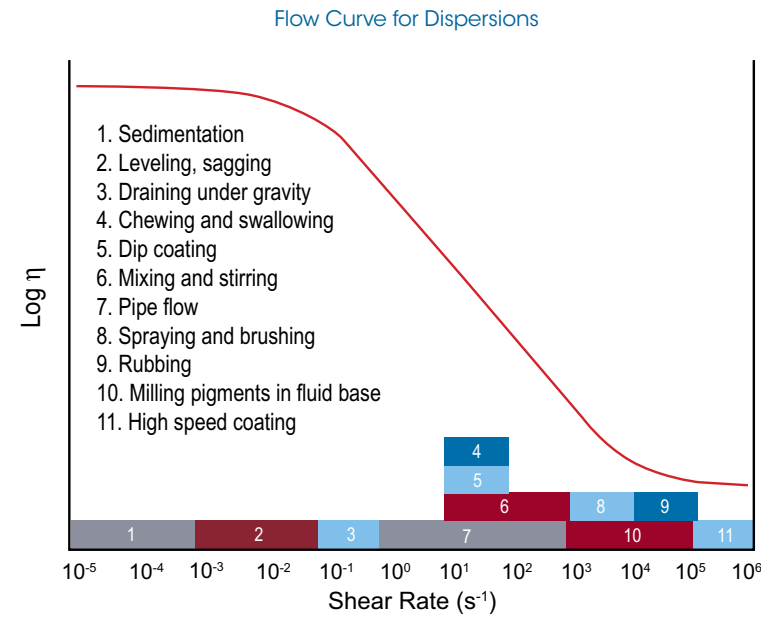

## Polymers

A polymer's molecular weight greatly influences its viscosity, while its molecular weight distribution and degree of branching affect its shear rate dependence. These differences are most apparent at low shear rates not possible with melt flow index or capillary devices. The ARES-G2 can determine molecular weight based on measurements of zero shear viscosity. Cox-Merz and TTS can be used to extend the data to higher shear rates.

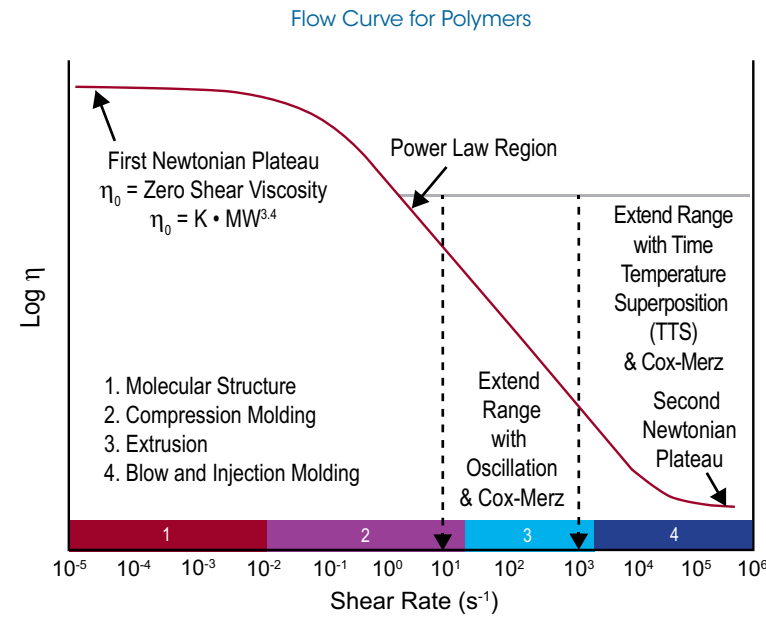

## Transient Testing

Transient tests, which include stress relaxation and creep recovery experiments, are named so because the deformation is applied to the sample in a step fashion. They are both highly sensitive tests for measuring viscoelastic properties of materials. The ARES-G2 is capable of both creep and stress relaxation testing. Thanks to an 800 mN.m motor, fast data acquisition, and the quasi-infinitely stiff torque rebalance transducer, the ARES-G2 achieves the fastest transient response times in both strain and strain-rate. In a creep recovery test a constant stress is applied to the sample and the resulting strain is measured over time. The stress is then removed and the recovery (recoil) strain is measured. In a stress relaxation test, an instantaneous strain is applied to the sample and held constant. The resulting stress decay is measured as a function of time yielding stress relaxation modulus  $G(t)$ .

## Creep and Recovery

Data from creep and recovery experiments performed on paint samples that were reported to have "good" and "bad" performance are shown in the figure below. This testing mode is a powerful tool for measuring viscoelastic properties and understanding and predicting material performance when under loads for long periods of time. Examples include settling stability in complex fluids, and zero shear viscosity and equilibrium recoverable compliance in polymer melts.

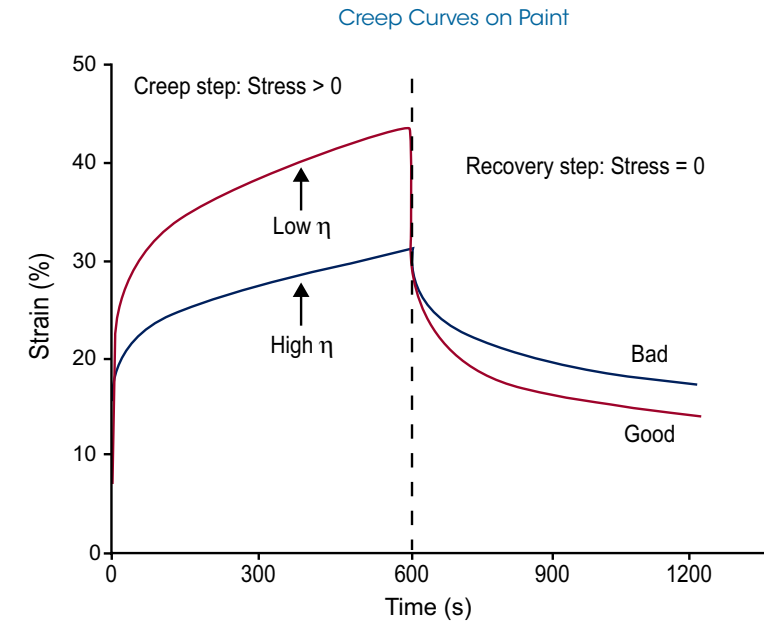

## Stress Relaxation

This example shows stress relaxation modulus  $G(t)$  for polydimethylsiloxane at a temperature of 25 °C.  $G(t)$  is calculated from the time-dependent stress decay divided by the applied strain. Stress relaxation experiments provide a quick and easy way to directly measure relaxation times in materials.

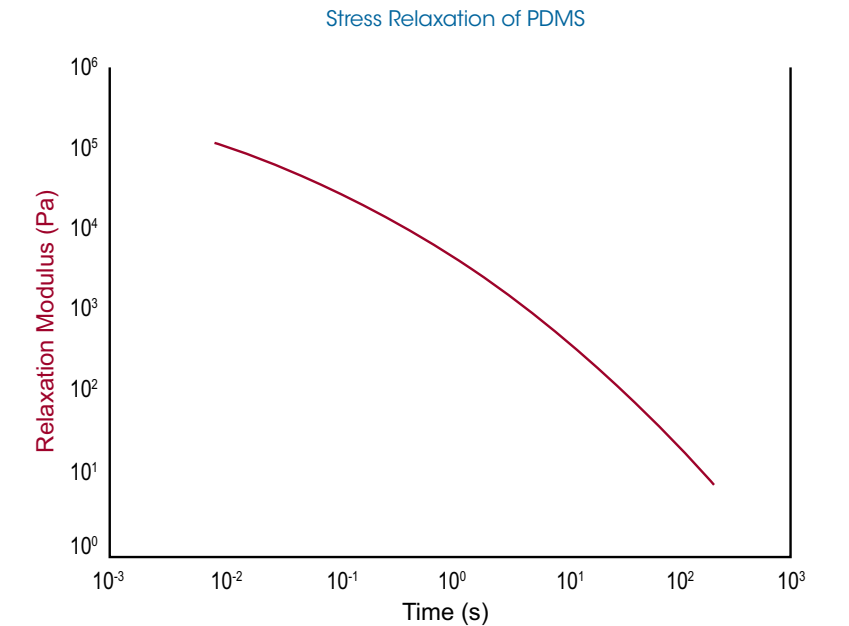

# ADVANCED | TESTING MODES & APPLICATIONS

The high-performance electronics and SMT design of the ARES-G2 make it the preferred choice for advanced testing modes. The fastest-response motor is ideal for applying complex deformation profiles and the Torque Rebalance Transducer provides correction-free data perfect for advanced analyses.

## Multiwave Frequency Sweep

Materials with a transient structure, such as curing thermosets or polymers that thermally or oxidatively degrade, require fast testing because they are changing as the test progresses. These are expediently tested in Multiwave mode. In this mode, two or more mechanical waves can be applied to a sample at the same time independently of one another. Because the waves act independently, the total imposed strain on the sample is the sum of strains caused by all the waves. The latter is an expression of the Boltzmann Superposition Principle, which holds so long as the total applied strain is within the linear viscoelastic region (LVR). Another advantage of this test mode is the ability to provide quick results compared to the standard frequency sweep; this would make it suitable as a high throughput tool. The data in the figure below were obtained using the Multiwave mode to monitor the curing behavior of an epoxy. The gel point is determined by the time at which  $\tan \delta$  is frequency-independent. The **separate motor and transducer design of the ARES-G2 makes it uniquely well-suited to the complex strains and stresses** that are created in a Multiwave experiment.

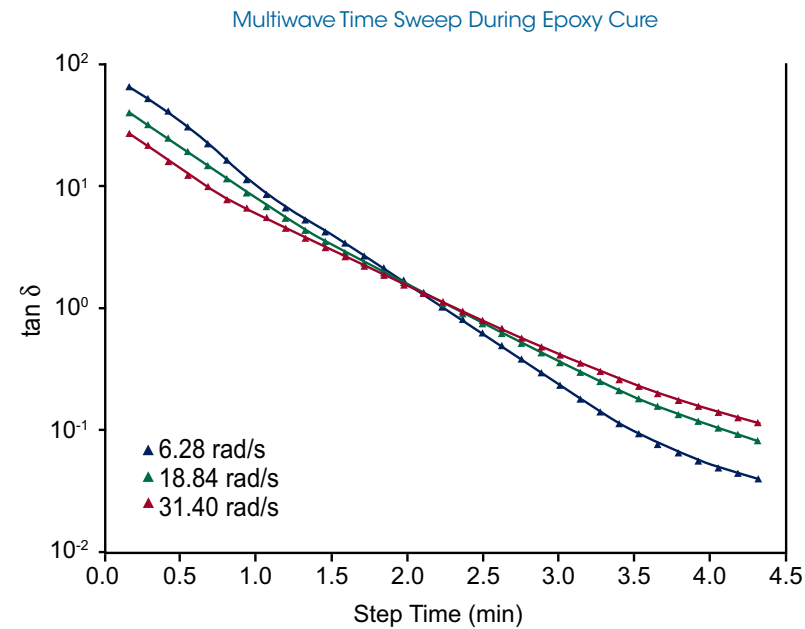

## Arbitrary Waveform Mode

This mode is particularly advantageous for testing materials that may change rapidly with time, for modeling shear behavior in processes, for increased sensitivity in transient tests, and for research in leading edge rheological studies. Not only a standard sinusoidal deformation, but virtually any user-defined waveform expressed by a mathematical equation can be applied. The input strain and resultant stress are measured as a function of time. TRIOS software uses a Fourier transform to convert the data to the frequency domain, and these data are used to calculate any of the material's viscoelastic properties.

In the below, the chosen input function is an "opera house" function, a sinusoidal function that continuously increases in frequency over the period of the lowest frequency. This is the fastest approach to determine the frequency spectrum in the shortest period of time. The continuous dynamic moduli calculated from the Fourier Transformation of the stress response are shown with data from a standard frequency sweep. The time needed to generate the continuous dynamic spectrum using the "opera house" function was 1000 seconds compared to 6600 seconds for a standard frequency sweep with 5 points per decade.

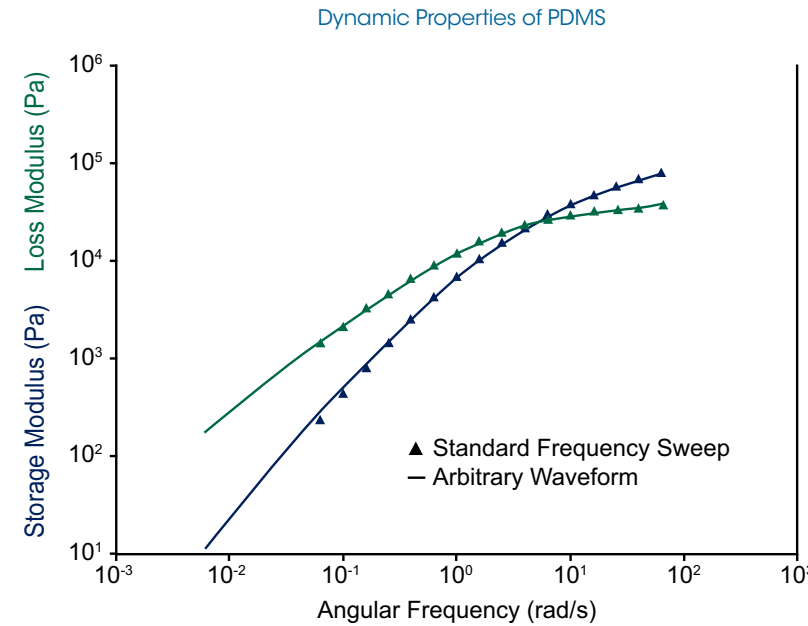

## Large Amplitude Oscillatory Shear (LAOS)

The ARES-G2 is equipped with new high-speed electronics with digital signal processing for transient and oscillatory testing allowing simultaneous collection of angular displacement, torque and normal force in all test modes. This enables fully integrated high speed data acquisition for transient (up to 8,000 Hz) and oscillation (up to 15,000 Hz) measurements. The high sampling speed provides superior resolution of magnitude and phase of the measured signals. This allows much better higher harmonic resolution for automatic analysis during oscillation tests or post Fourier transformation analysis. Higher harmonics that occur in the stress signal in oscillation tests are a result of a non-linear response. This is illustrated for LDPE measured with the Cone and Partitioned Plate accessory in the figure below. High speed data acquisition is then essential to capture the true material's stress response. This capability establishes the ARES-G2 rheometer as the **ideal platform to perform highly accurate LAOS experiments and provide the most trusted fundamental and higher order harmonic data**. An optional software package is available to analyze transient oscillation data and provide all non-linear material parameters such as:  $G'_L$ ,  $G'_M$ ,  $\eta'_L$ ,  $\eta'_M$ , S, T, and Q.

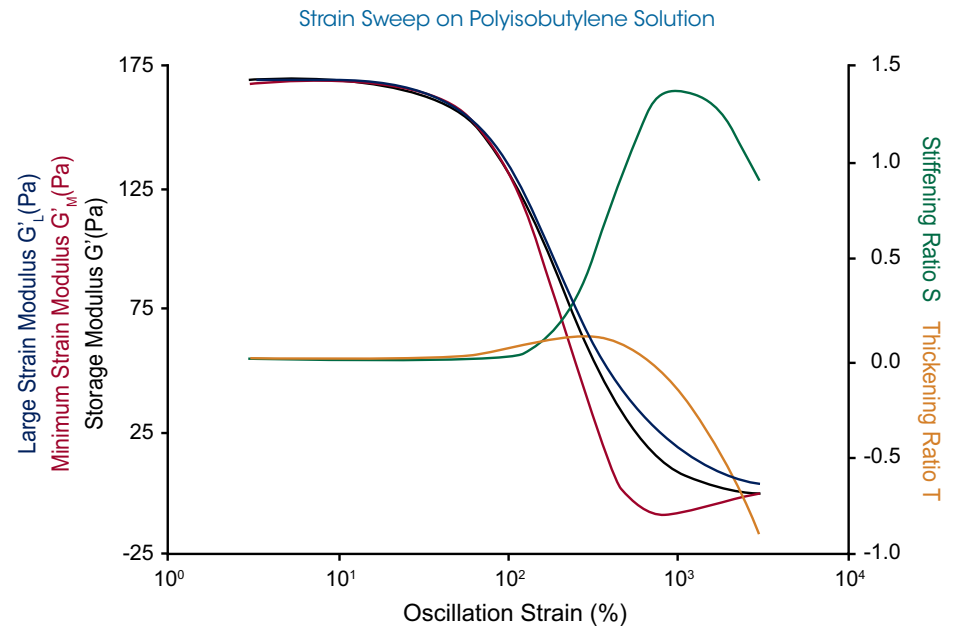
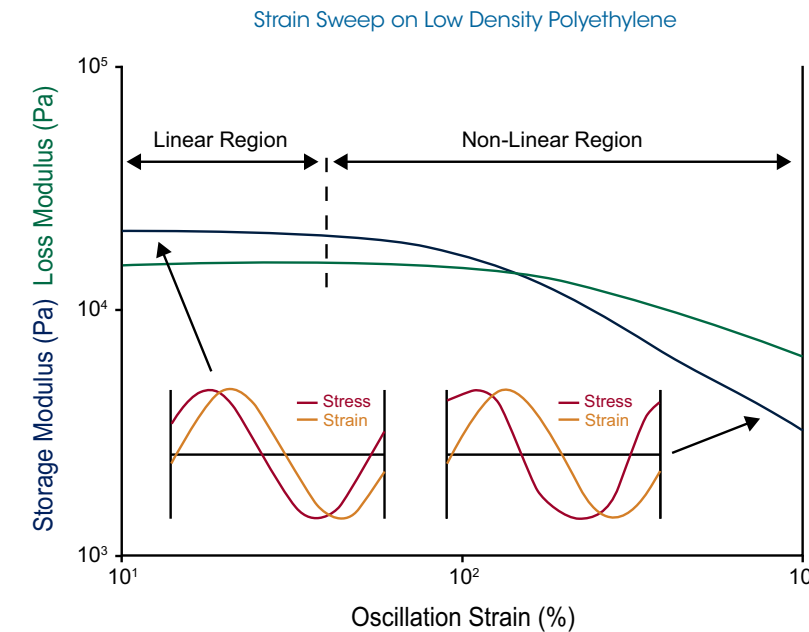

# ORTHOGONAL SUPERPOSITION | TESTING MODES & APPLICATIONS

## A New Dimension in Dual Head Rheological Testing

TA Instruments introduces a new dimension in rheological testing exclusive to the ARES-G2. Simultaneous deformation in the angular and axial directions unlocks all new capabilities for probing non-linear and anisotropic behavior of complex fluids. This new testing capability utilizes the unique capabilities of the ARES-G2 FRT to apply oscillation in the axial direction, orthogonal to the direction of angular shear.



### Features and Benefits

- Exclusive to the ARES-G2 rheometer
- Double gap concentric cylinder
- OSP and 2D-SAOS experiments fully programmable from TRIOS Software
- Simultaneous measurements in two directions
- Advanced Peltier System temperature control

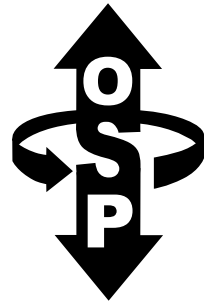

## Orthogonal Superposition (OSP)

### A New Test of Non-Linear Viscoelasticity

Orthogonal Superposition provides an additional powerful method to probe non-linear viscoelasticity. Steady shearing deformation in the angular direction is coupled with an oscillatory deformation applied by the ARES-G2 FRT in the axial direction. Steady state properties in the flow direction and dynamic properties orthogonal to flow are measured. This flow is well-controlled and the viscoelastic response is easily interpreted.

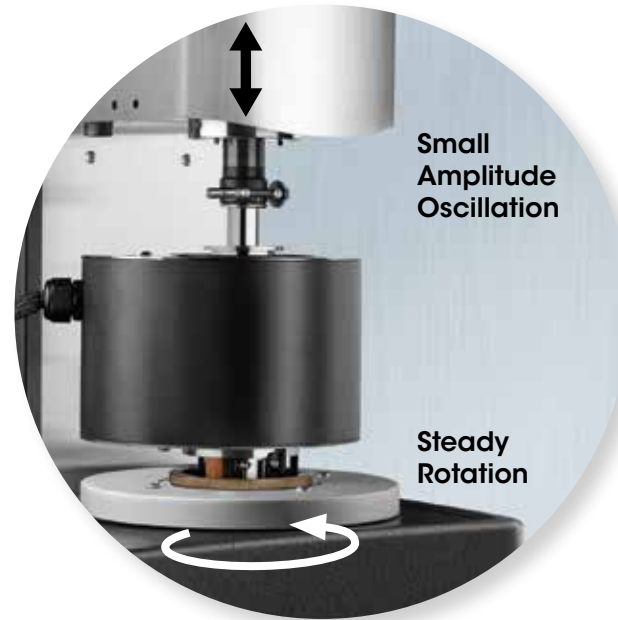

## 2 Dimensional Small Amplitude Oscillatory Shear (2D-SAOS)

### A Selective Probe of Anisotropy

2D-SAOS measures linear viscoelasticity with directional selectivity. This is especially valuable for understanding anisotropy in complex fluids. Simultaneous oscillatory deformations in the angular and axial directions produce either linear oscillations at a controlled angle or local rotational flows, which provide a complete understanding of anisotropy in a single oscillation period.

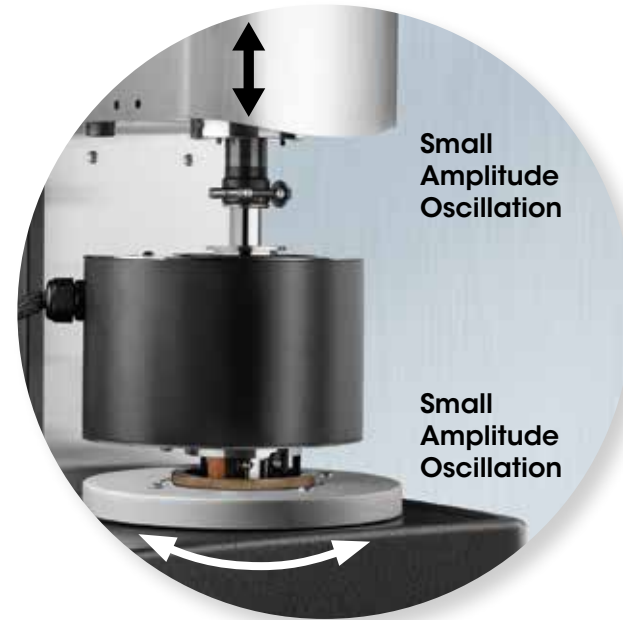

## Xanthan Gum Solution

An orthogonal superposition experiment was performed on a 2% Xanthan Gum solution in water while subjected to steady shear from 0 s<sup>-1</sup> to 10 s<sup>-1</sup>. A frequency sweep was performed simultaneously, revealing the dynamic moduli orthogonal to the direction of steady shear. This demonstrates that the time scale of terminal flow - indicated by the crossover frequency - moves to shorter time scales as the shear rate increases.

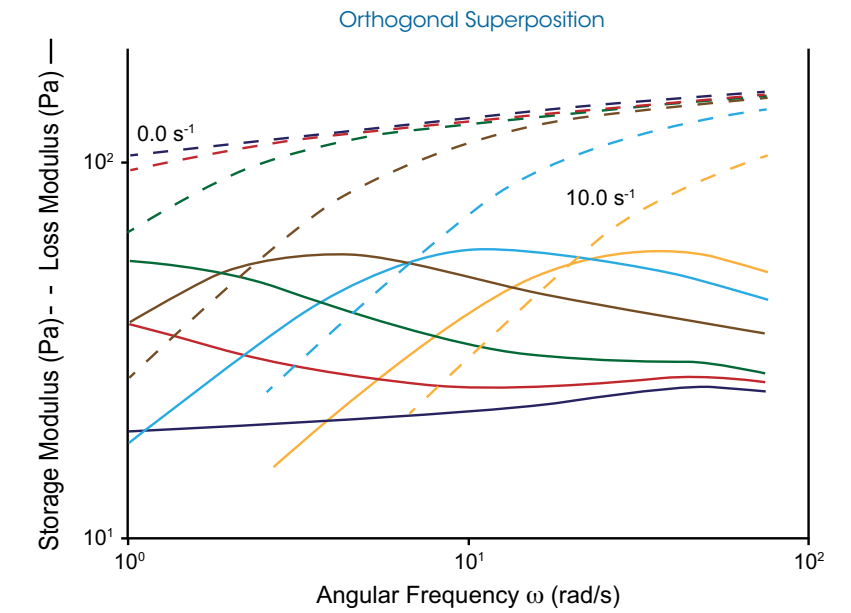

## Highly Filled Dental Adhesive Paste

2D-SAOS reveals anisotropy in a fluid, which may be induced by sample shear history. This highly-filled dental adhesive paste underwent pronounced alignment as the result of previous shear flow. The sample was subjected to an isotropic two-dimensional small amplitude deformation. The resulting stress is clearly anisotropic, revealing the anisotropy of the fluid. This technique can be particularly helpful when exploring thixotropic behavior in filled systems.

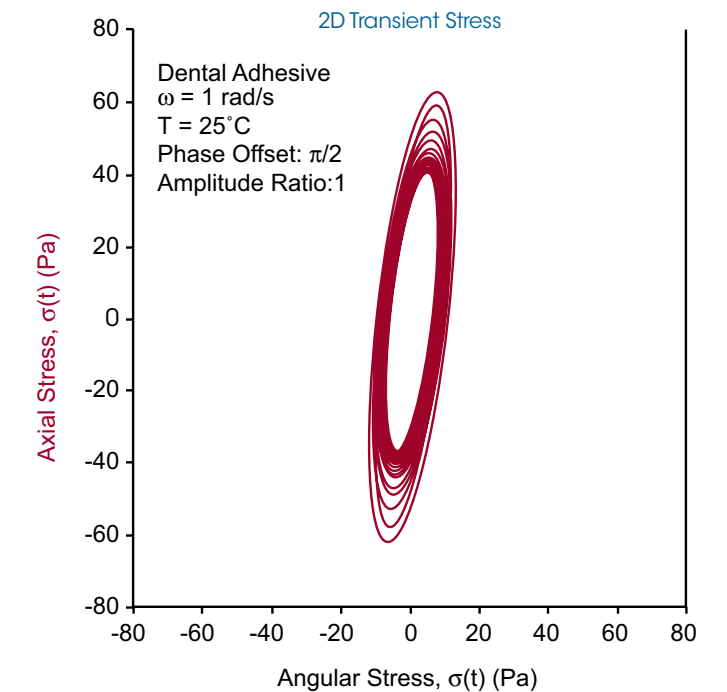
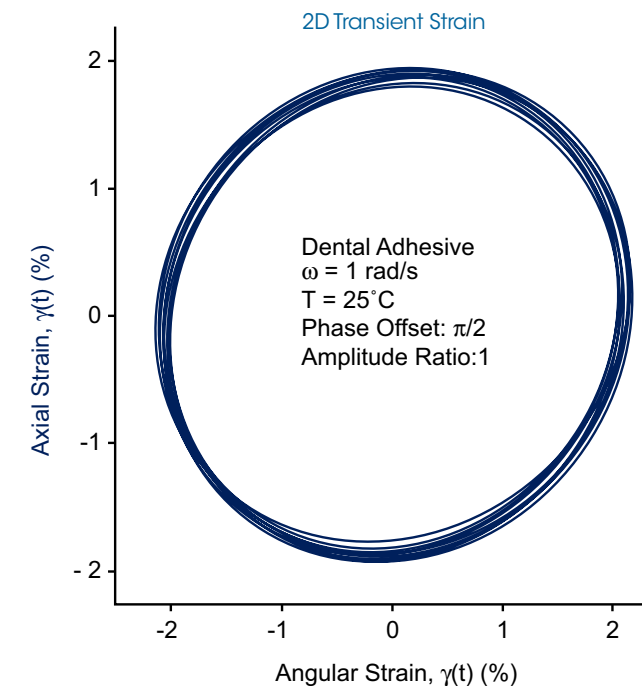



# DYNAMIC MECHANICAL ANALYSIS | TESTING MODES & APPLICATIONS

## Axial Bending, Tension and Compression

Thanks to the unique TA Instruments Force Rebalance Transducer (FRT) technology, the ARES-G2 rheometer is a **rotational rheometer that is also capable of performing linear Dynamic Mechanical Analysis (DMA)** on solids in bending, tension and compression. Axial sample deformation is applied by driving the high sensitivity FRT in controlled strain sinusoidal oscillation, unlocking all new capabilities for solids testing.

## Features and Benefits

- Wide range of geometries:
  - 3-Point Bending
  - Film/Fiber Tension
  - Single and Dual Cantilever (Clamped Bending)
  - Parallel Plates Compression
- Axial Force Control tracks material stiffness and automatically adapts static load
- AutoStrain adjusts applied strain to changing sample stiffness
- Responsive FCO temperature control: -150 °C to 600 °C
- Sample visualization with FCO camera

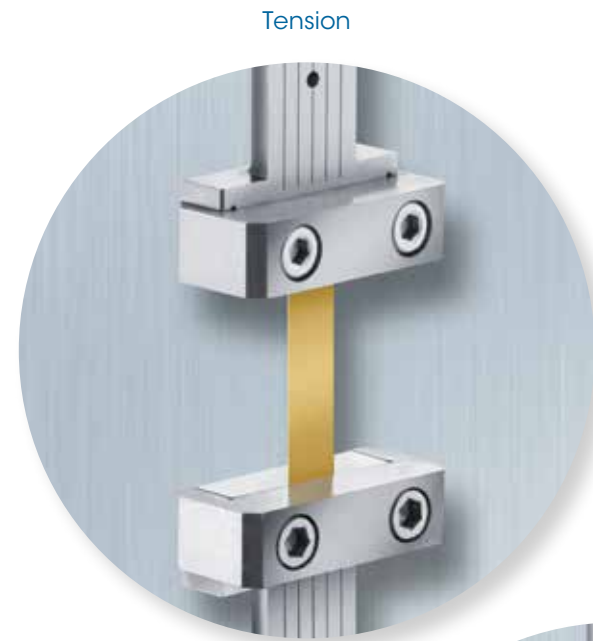

Tension

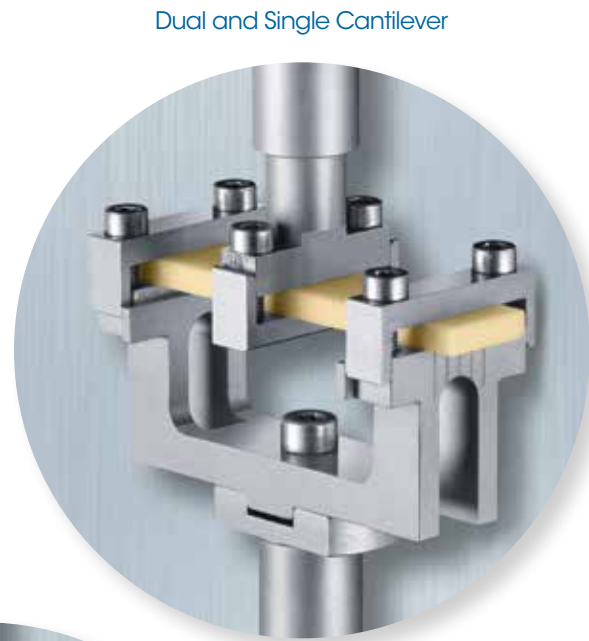

Dual and Single Cantilever

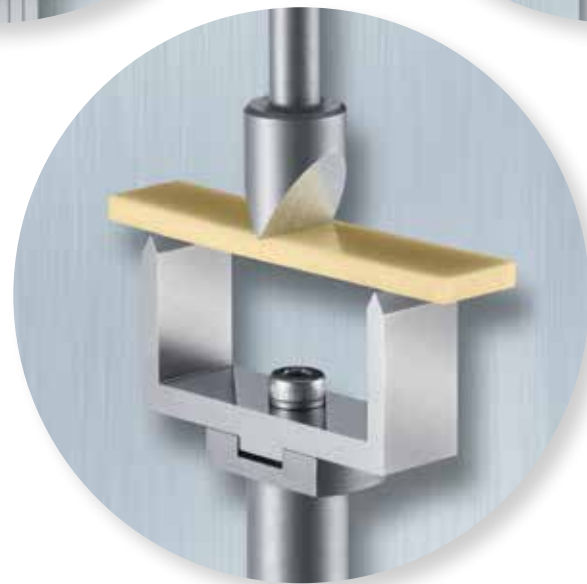

3-Point Bending

## Polyester Film in Tension Mode

An oscillation temperature ramp was performed on a 50 µm thick PET film using the tension geometry over a temperature range of 50 °C to 250 °C. Two major transitions are observed: a glass transition about 109 °C, and melting at 234 °C. The material exhibits a significant shrinkage, as shown in the change of length signal  $\Delta L$ , above the glass transition.

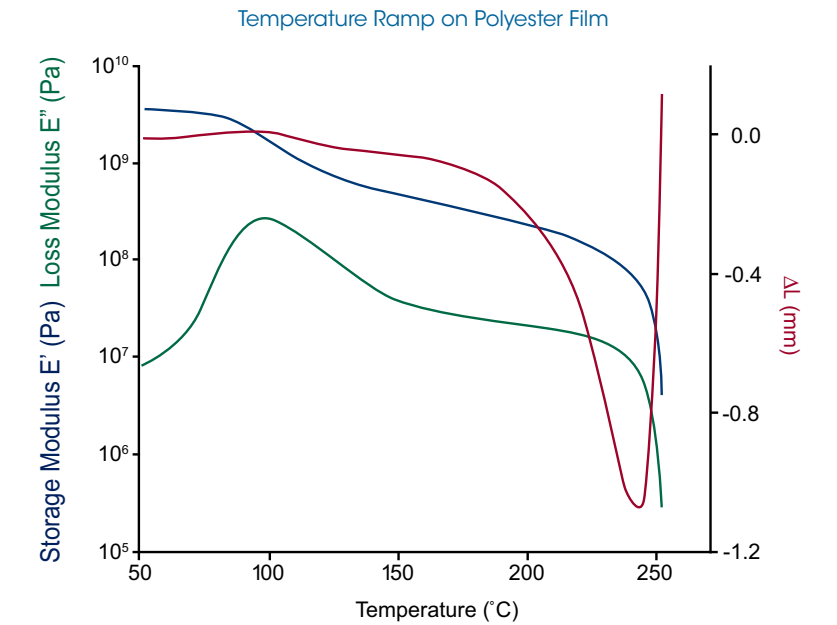

## ABS in 3-Point Bending Mode

The benefits of both Axial Force Control and AutoStrain are highlighted in this oscillation temperature ramp on an ABS bar tested in 3-point bend geometry. Axial Force Control moves the cross-head such that the clamp maintains continuous contact with the sample. This contact force is adjusted throughout the test to track thermal expansion and large changes in the material's modulus during the glass transition, preventing sample bowing. AutoStrain is also used to adjust the input strain, maintaining an optimal oscillation force under all conditions. These features work in concert to ensure the highest quality data on all samples and conditions with minimal experimental optimization.

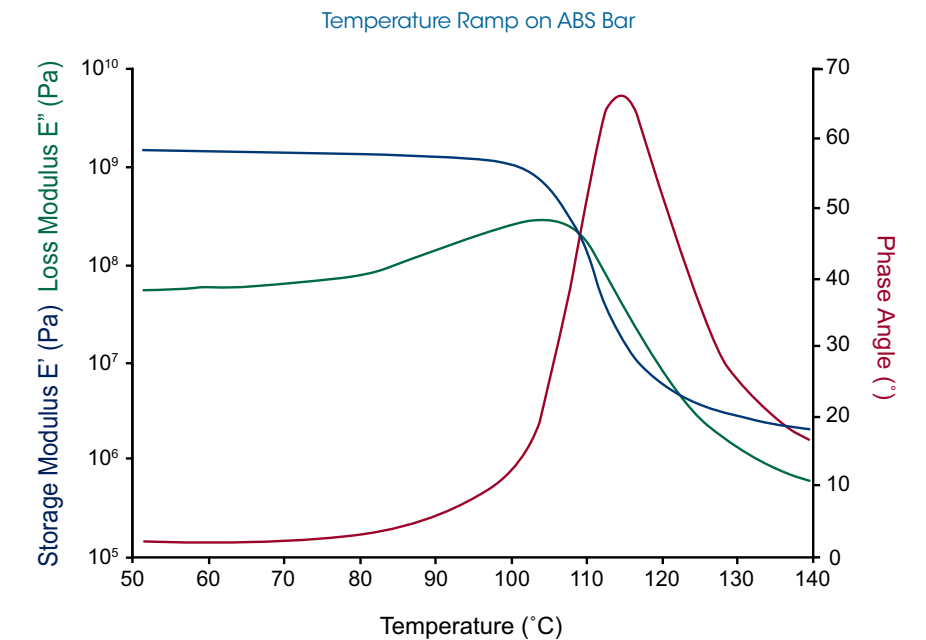

## High Sensitivity Pressure Cell Accessory

The all new High Sensitivity Pressure Cell (HSPC) for the ARES-G2 unlocks complete viscoelastic characterization of fluids in a pressurized environment. The HSPC is the only device that provides a wide range of dynamic oscillatory testing of materials, including low viscosity polymer solutions and structured fluids under controlled atmospheric pressure. Conventional pressure cells employ mechanical bearings that severely limit low torque sensitivity and make viscoelastic characterization impractical for most samples. The HSPC employs an innovative air bearing seal that allows unrivaled low torque performance with **100x better torque sensitivity** than conventional devices, allowing users to characterize critical material behavior such as time, frequency, and strain-dependence on the widest range of fluids.

The HSPC provides atmospheric pressure control up to 5 bar and is paired with the Advanced Peltier System (APS) for stable and accurate temperature control from -10°C to 150°C, providing viscoelastic measurements over a wide range of testing conditions, including at temperatures above the boiling point of volatile components. This new range of test conditions can provide insight to material properties representative of extreme processing or use conditions, such as downhole or extrusion environments.

The HSPC's concentric cylinder measurement system utilizes compressed air flows and an innovative cap design to pressurize the sample volume. A self-aligning design makes the HSPC quick and easy to assemble for anyone, resulting in guaranteed **low torque** measurements, outstanding reproducibility, and more time for testing. Sample pressure is directly measured and saved for a complete record of the sample environment, storing all relevant test information in one convenient TRIOS data file. The High Sensitivity Pressure Cell (HSPC) extends the inertia-free dynamic oscillatory testing capabilities, exclusive to the ARES-G2, to include pressurized test conditions with unrivaled low torque sensitivity for testing on the widest range of fluids.



## Features and Benefits

- Innovative, non-mechanical bearing design provides 100x improved torque sensitivity for testing a wide range of fluids, including polymer solutions and structured fluids
- Unrivaled low torque sensitivity of 1  $\mu\text{N}\cdot\text{m}$  for characterizing low viscosity fluids and weakly structured materials
- Extensive dynamic oscillatory testing capabilities to characterize time, frequency, and strain-dependent viscoelastic behavior
- Stable and accurate temperature control from -10°C to 150°C with the Advanced Peltier System (APS)
- Atmospheric pressure control up to 5 bar allows simulation of extreme processing and use conditions over a wide range of operating parameters
- Completely integrated experience with rheological data and sample pressure directly measured and recorded through powerful TRIOS software
- User-friendly, self-aligning design guarantees low torque performance for everyone, every time

## Performance Specifications

Temperature Range	-10°C – 150°C
Pressure Range	0 – 5 bar
Minimum Torque	1 $\mu\text{N}\cdot\text{m}$
Pressurized Gas	Air or Nitrogen

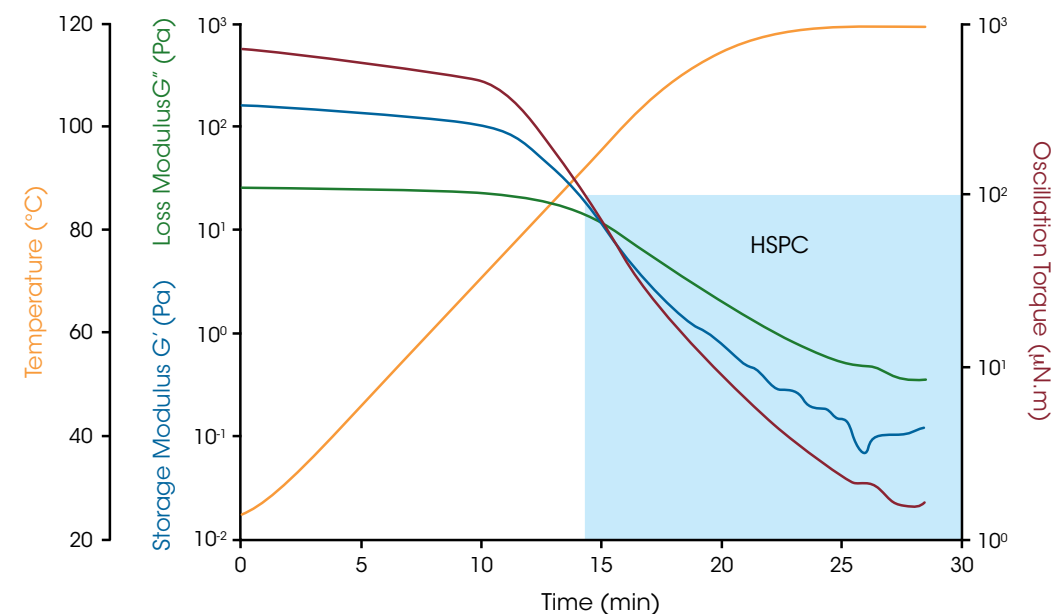

## Characterization of Xanthan Gum Solution Under Pressure

Characterizing viscoelastic properties of fluids at temperatures above boiling poses significant challenges, most notably the loss of volatile ingredients resulting in changes to material composition. Various methods and devices have been employed to trap solvents or suppress evaporation; these can delay compositional changes at higher temperatures but are ineffective beyond the boiling point. A pressurized testing environment is the only means to characterize the rheological properties of materials under such conditions. Xanthan gum is often used as an additive for gelling and food applications. A solution of 2.5 wt% of xanthan gum in water was tested in the High Sensitivity Pressure Cell as the temperature was increased at 5°C/min from 25°C to 120°C. The evolution of the dynamic moduli ( $G'$  and  $G''$ ) was measured over the entire temperature range, even above the boiling temperature of water. A crossover point is clearly identified near 95°C, indicating the transition from a gelled state to a liquid-like polymer solution. Tracking the changing viscoelastic properties and identifying important points of interest such as the modulus crossover provide insight into the full viscoelastic behavior of materials in extreme processing or use conditions.

## Electrorheology (ER) Accessory

Electrorheology (ER) fluids are suspensions of extremely fine non-conducting particles in an electrically insulating fluid, which show dramatic and reversible rheological changes when the electric field is applied. The ARES-G2 ER accessory provides the ability to apply up to 4,000 volts during the course of an experiment using either parallel plate or concentric cylinder geometry. The voltage is applied to the sample via a Trek Amplifier through a high voltage cable. An insulator block between the transducer hub and the upper geometry isolates it from the circuit. Tests can be run with the Advanced Peltier System over the range of temperature from -10 °C to 150 °C.



## Step Voltage on Starch Suspension under Steady Shear

A 10% starch solution in silicone oil demonstrates dramatic and reversible changes in structure under the application of high voltage. The figure shows time-dependent viscosity with varying DC voltage, from 500 to 4000 V, applied for 100 s. The underlying rheological test is a constant rate at 1 s<sup>-1</sup>, which minimizes the disturbance to the structuring process. When an electrical field is applied, polarization of the starch particles in the non-conducting silicone oil leads to stringing of the starch particles, which align between the electrode plates. This orientation is responsible for the strong viscosity increase. The time to align the particles depends on the viscosity of the suspending fluid and the strength of the electrical field. Because under the applied shear rate, deformation of the structuring process is not completely eliminated, a maximum viscosity is observed when the dynamic equilibrium between forming and breaking of strings of aligned particles is achieved.

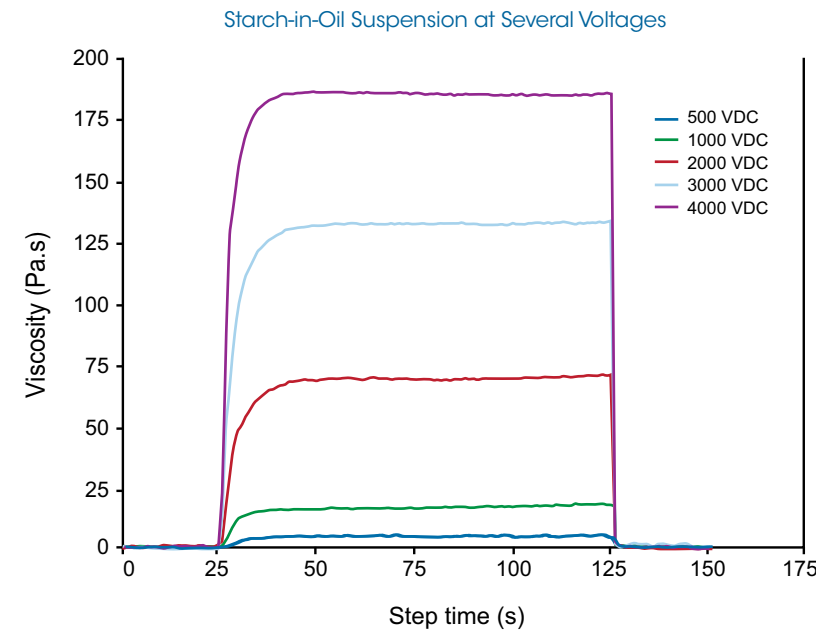

## Dielectric Thermal Analysis Accessory (DETA)

The ARES-G2 DETA is an accessory which expands the testing capability of the ARES-G2 rheometer to measure the electric response of materials through probing the capacitive and conductive properties. The DETA accessory is easily installed or removed from the ARES-G2 rheometer. The ARES-G2 platform provides flexible and easy experimental setup and superior DETA data accuracy through standard features, such as the Forced Convection Oven for temperature control to 350 °C, axial force control to 20 N with gap temperature compensation capability, and TRIOS software. The accessory can be configured with 25 mm standard plates or 8 mm to 40 mm disposable plates. The DETA can be operated with the ARES-G2 in stand-alone mode or in simultaneous dielectric and mechanical measurement mode. The system is compatible with two popular Keysight LCR meters: E4980A (20 Hz to 2 MHz, 0.005 to 20 V) and 4285A (75 kHz to 30 MHz, 0.005 to 10 V).

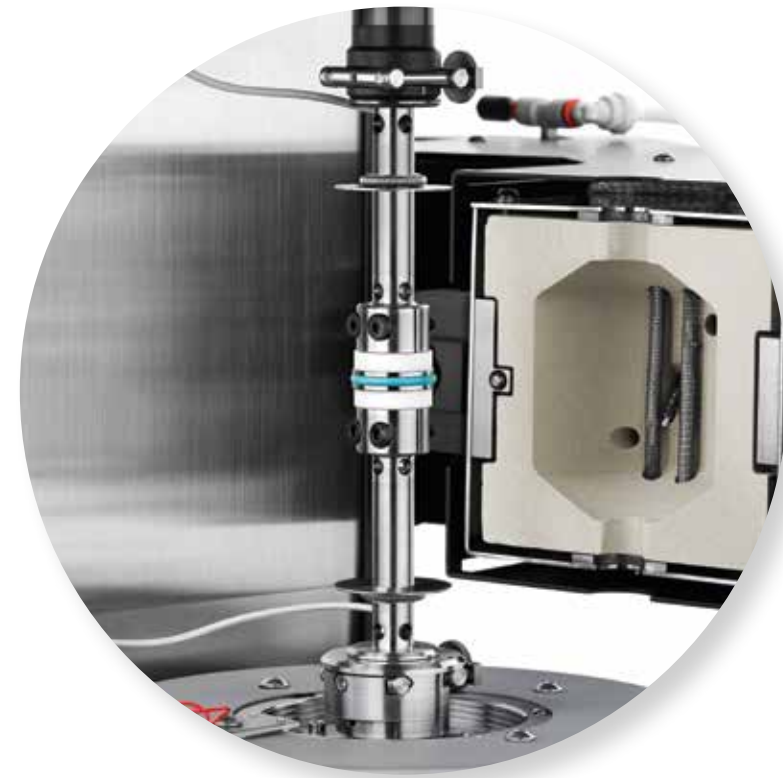

## Dielectric Temperature Ramp at Multiple Frequencies

The figure below shows a temperature ramp on a poly (methyl methacrylate), PMMA, sample at four different dielectric frequencies ranging from 1 kHz to 1 MHz. It can be seen here that the magnitude of  $\epsilon'$  decreases with increasing frequency through the transition region and the peak of the transition in  $\tan \delta$  moves to higher temperatures with increasing frequency.

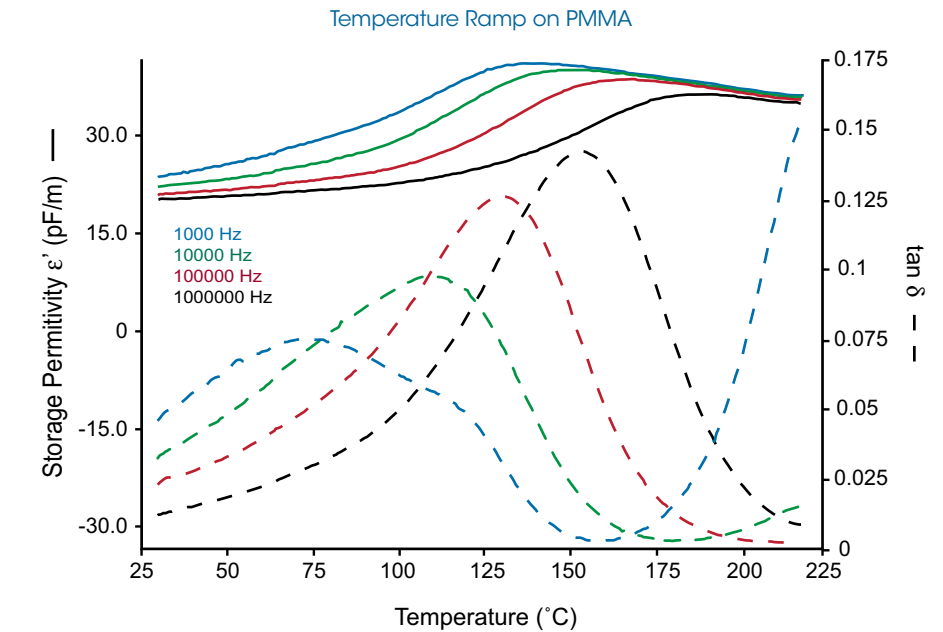



## UV Curing Accessory

UV curing adhesives and radiation curable adhesives use ultraviolet light or other radiation sources to initiate curing, which allows a permanent bond without heating. The ARES-G2 UV Curing Accessory uses a light guide and reflecting mirror assembly to transfer UV radiation from a high-pressure mercury light source to the sample for measurement of the storage and loss moduli during the curing reaction. The accessory includes upper and lower geometry with removable 20 mm diameter plates, collimator, 5 mm waveguide, and remote radiometer/dosimeter. The system interfaces with a UV light source (Omniculture S2000) with wavelengths in the range of 320 to 500 nm. Optional temperature control to a maximum of 150 °C is available using the Advanced Peltier System, APS. Disposable Plates are also available for curing systems.



## UV Curing

A pressure sensitive adhesive (PSA) was characterized with the UV Curing Accessory. The PSA was held at an isothermal temperature of 25 °C and the curing profile was measured at radiation intensities from 50 mW/cm<sup>2</sup> to 150 mW/cm<sup>2</sup>. The sample was measured for 30 seconds before the light was turned on. The data show faster reaction kinetics with increasing intensity, as evidenced by the shorter time for crossover of G' and G''. Similar results can be obtained with controlled temperature, where the reaction is seen to occur more quickly at higher temperatures. The curing reaction happens in less than two seconds. The fast data acquisition of the ARES-G2 (up to 50 pts/sec) enables clear identification of the liquid to solid transition. Note that changing the intensity and temperature by small amounts shifts the crossover point by a fraction of a second. This information is important for understanding adhesive control parameters for high-speed UV curing processes, as well as for understanding differences in initiators when formulating materials.

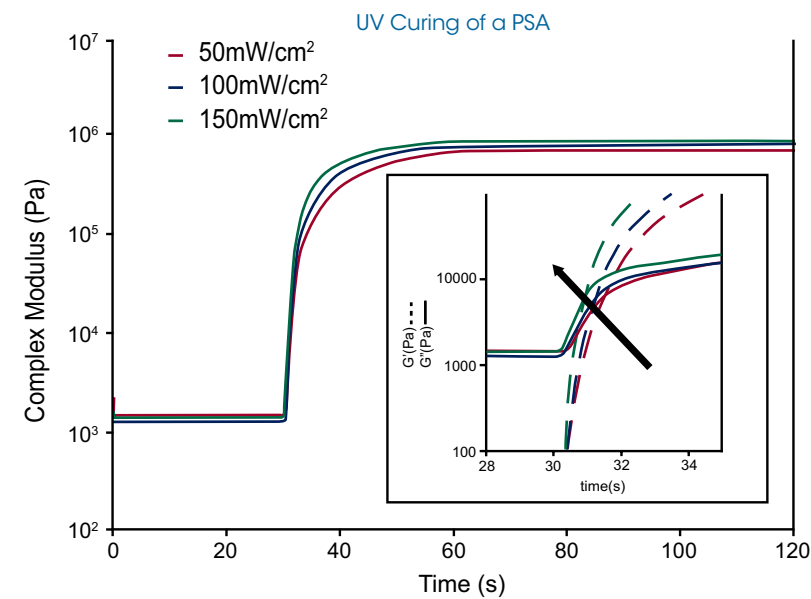

## Interfacial Rheology

Rheometers are typically used for measuring bulk or three-dimensional properties of materials. In many materials, such as pharmaceuticals, foods, personal care products and coatings, there is a two-dimensional liquid/liquid or gas/liquid interface with distinct rheological properties. The patented Double Wall Ring (DWR) system is compatible with the ARES-G2 for quantitative viscosity and viscoelastic information over the widest measurement ranges. The sample is contained in a Delrin trough and the measuring ring is made of platinum-iridium. These materials are selected for their inert chemistry and ease of cleaning. The double wall geometry provides interfacial shear planes on both sides of the geometry surface for higher sensitivity to the monolayer viscoelastic response at liquid-air or liquid-gas interfaces. The Double Wall Ring is capable of truly quantitative viscoelastic parameters because the interface is "pinned" to the diamond-shaped cross-section of the geometry ring. This patented ring (Patent # 7,926,326) has a diameter of 60 mm and was designed for ease-of-use and maximum sensitivity. Surface viscosity measurements can be conducted on surface viscosities as low as 10<sup>-5</sup> Pa.s.m without complicated sub-phase corrections. Oscillation measurements are possible over the widest frequency range of any interfacial system.



## Interfacial Properties of SPAN 65 at a Water-dodecane Interface

SPAN 65 is a complex surfactant with a non-linear architecture. It segregates to the interface between water and dodecane, forming a viscoelastic monolayer which is characterized by the ARES-G2 with Double Wall Ring. The figure below shows the evolution of the interface formation over 70 minutes highlighted by the increase in storage modulus. The viscoelastic character of the interfacial assembly is evident in the frequency sweep to the right. The G', G'' crossover point at 0.2 rad/s and a dominant elastic character at higher frequencies demonstrate the strong interfacial structure. Only the high sensitivity inertia-free measurements of the ARES-G2 allow the full viscoelastic characterization of an interface at frequencies as high as 100 rad/s.

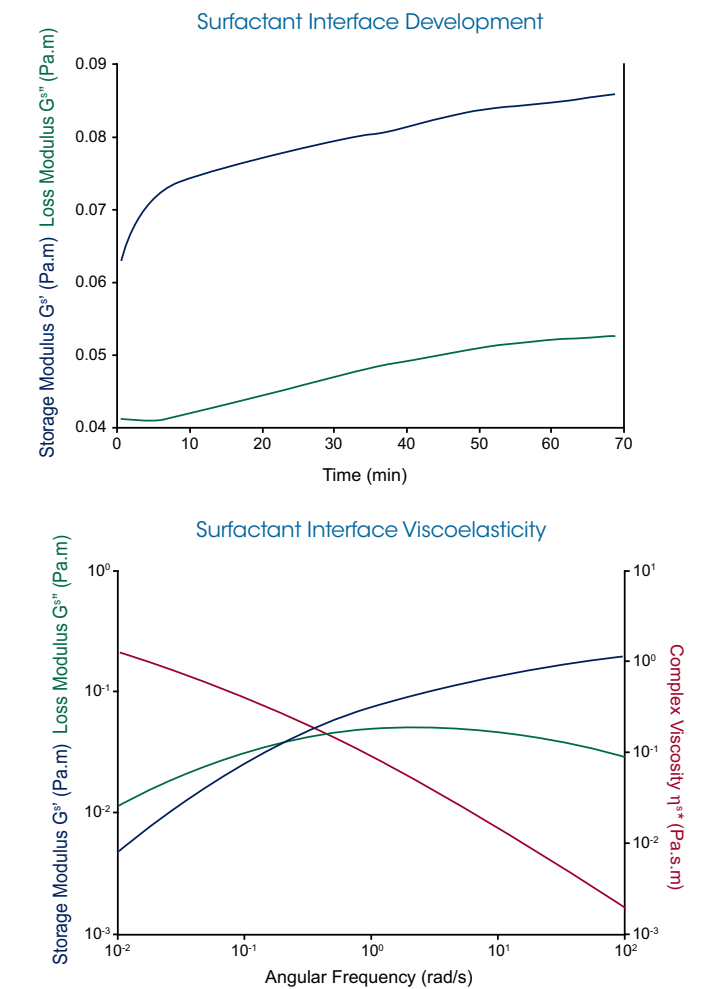

## Tribo-Rheometry Accessory

The new Tribo-Rheometry Accessory enables the measurement of friction and wear directly under the widest range of industrial conditions. This system employs a modular set of standard and novel geometries to add entirely new capability to the ARES-G2 rotational shear rheometer. The coefficient of friction of two solid surfaces in contact can be measured under multiple dry and lubricated conditions and contact profiles. An innovative new self-aligning design ensures uniform solid-solid contact in an easy-to-use and quick-to-install accessory. Tribology experiments also benefit from the preeminent speed control of the ARES-G2, separate torque measurement, and the unrivaled normal force accuracy and stability of the Force Rebalance Transducer.



Ball on Three Plates

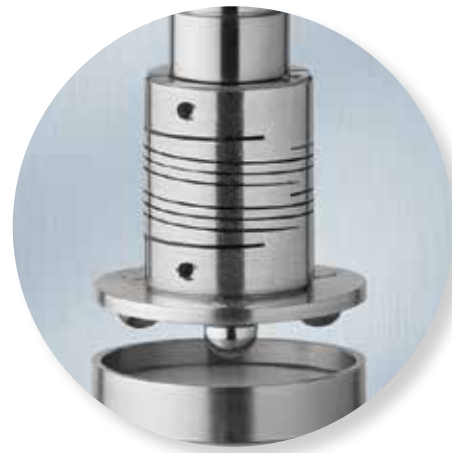

Three Balls on Plate



Ring on Plate



Ball on Three Balls

The Tribo-Rheometry Accessory is compatible with both the Advanced Peltier System (APS) and Forced Convection Oven (FCO) for accurate and stable temperature control for all test geometries. A variety of available contact profiles meet the diverse requirements of tribology applications. The available testing geometries are Ring on Plate, Ball on Three Plates, Three Balls on Plate, and Ball on Three Balls. The ring on plate geometry may also be configured as a partitioned ring, which permits the replenishment of liquid lubrication. The accessory's versatile configurations and interchangeable substrates are ideal for studying the effect of friction and long-term wear on materials ranging from automotive components and greases, lubrication in prosthetic devices, and the performance of personal care creams and lotions.

Experiments are controlled and results are calculated directly through the advanced TRIOS software. Measured quantities include the coefficient of friction ( $\mu$ ), load force ( $F_L$ ), friction force ( $F_f$ ) and Gumbel number ( $G_u$ ). These may be used to construct Stribeck curves, static friction measurements, or explore specific combinations of temperature, contact force, and motion.

## Stainless Steel Ring on PVC Plate

The accompanying figure shows the coefficient of friction between a Stainless Steel ring and a PVC plate lubricated by silicone oil. As the sliding speed between the surfaces is increased, the coefficient of friction initially decreases before systematically increasing with a marked dependence on the axial load. The initial decrease reflects the lubrication of the surface by the silicone oil; increased friction at higher speeds suggests a crossover into the hydrodynamic region of the Stribeck curve where frictional effects are dominated by fluid drag.

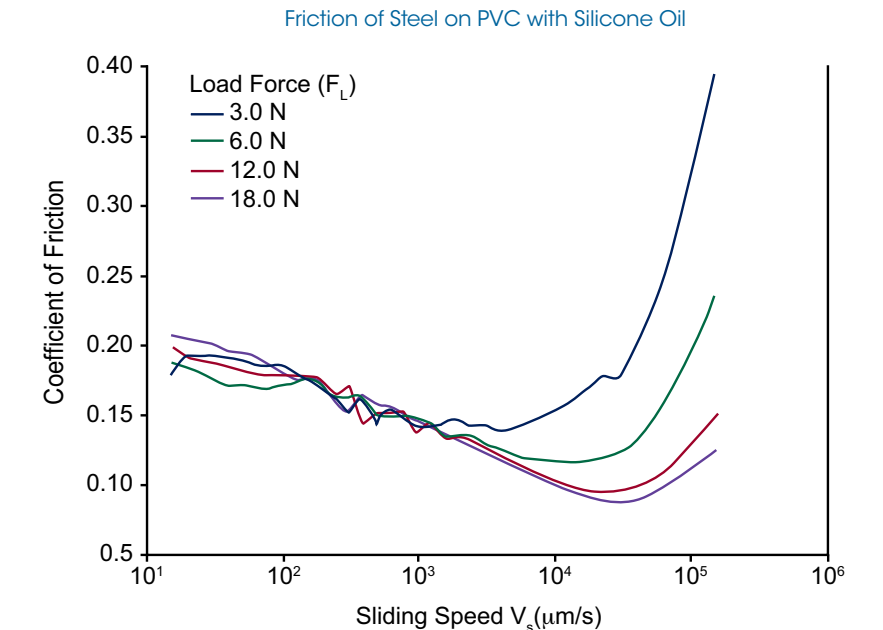

	Temperature Range		Max Load Force	Max Sliding Speed
	APS	FCO		
<b>Ring on Plate</b>	-10 °C to 150 °C	-150 °C to 180 °C	20 N	4.5 m/s
<b>Ball on Three Plates</b>	-10 °C to 150 °C	-150 °C to 350 °C	28 N	2.7 m/s
<b>Ball on Three Balls</b>	-10 °C to 150 °C	-150 °C to 350 °C	24 N	2.3 m/s
<b>Three Balls on Plate</b>	-10 °C to 150 °C	-150 °C to 180 °C	20 N	4.5 m/s



### Air Chiller Systems (ACS-2 and ACS-3)

The new Air Chiller Systems are unique gas flow cooling systems that enable temperature control of the Forced Convection Oven without the use of liquid nitrogen. Equipped with multi-stage cascading compressors, the ACS-2 and ACS-3 permit operation of the FCO at temperatures as low as -55 °C and -100 °C, respectively. Utilizing compressed air, the Air Chiller Systems can help eliminate or reduce liquid nitrogen usage from any laboratory and offers an incredible return on investment.

### Features and Benefits

- Safe:** Eliminates the need for liquid nitrogen or other refrigerated gases
- Convenient:** Never change, refill, or order another tank of liquid nitrogen.
- Small:** Occupies less space than equivalent liquid nitrogen cooling systems.
- Affordable:** Provides considerable cost savings over recurring gas deliveries.

### Force/Torque Rebalance Transducer (Sample Stress)

Transducer Type	Force/Torque Rebalance
Transducer Torque Motor	Brushless DC
Transducer Normal/Axial Motor	Brushless DC
Minimum Transducer Torque in Oscillation	0.05 µN.m
Minimum Transducer Torque in Steady Shear	0.1 µN.m
Maximum Transducer Torque	200 mN.m
Transducer Torque Resolution	1 nN.m
Transducer Normal/Axial Force Range	0.001 to 20 N
Transducer Bearing	Groove Compensated Air

### Drive Motor (Sample Deformation)

Maximum Motor Torque	800 mN.m
Motor Design	Brushless DC
Motor Bearing	Jeweled Air, Sapphire
Displacement Control/Sensing	Optical Encoder
Strain Resolution	0.04 µrad
Min. Angular Displacement in Oscillation	1 µrad
Max. Angular Displacement in Steady Shear	Unlimited
Angular Velocity Range	1 x 10 <sup>-6</sup> rad/s to 300 rad/s
Angular Frequency Range	1 x 10 <sup>-7</sup> rad/s to 628 rad/s
Step Change in Velocity	5 ms
Step Change in Strain	10 ms

### Orthogonal Superposition and DMA modes

Motor Control	Force Rebalance Transducer
Minimum Transducer Force in Oscillation	0.001 N
Maximum Transducer Force	20 N
Minimum Displacement in Oscillation	0.5 µm
Maximum Displacement in Oscillation	50 µm
Displacement Resolution	10 nm
Axial Frequency range	1 x 10 <sup>5</sup> Hz to 16 Hz

### Stepper Motor

Movement/Positioning	Micro-stepping Motor/Precision Lead Screw
Position Measurement	Linear Optical Encoder
Positioning Accuracy	0.1 µm

### Temperature Systems

Smart Swap™	Standard
Forced Convection Oven, FCO	-150 °C to 600 °C
FCO Camera Viewer	Optional
Advanced Peltier System, APS	-10 °C to 150 °C
Peltier Plate	-40 °C to 180 °C
Sealed Bath	-10 °C to 150 °C







## AMERICAS

- New Castle, DE USA
- Lindon, UT USA
- Wakefield, MA USA
- Eden Prairie, MN USA
- Chicago, IL USA
- Irvine, CA USA
- Montreal, Canada
- Toronto, Canada
- Mexico City, Mexico
- São Paulo, Brazil

## EUROPE

- Hüllhorst, Germany
- Bochum, Germany
- Eschborn, Germany
- Wetzlar, Germany
- Elstree, United Kingdom
- Brussels, Belgium
- Ettlen-Leur, Netherlands
- Paris, France
- Barcelona, Spain
- Milano, Italy
- Warsaw, Poland
- Prague, Czech Republic
- Sollentuna, Sweden
- Copenhagen, Denmark

## ASIA & AUSTRALIA

- Shanghai, China
- Beijing, China
- Tokyo, Japan
- Seoul, South Korea
- Taipei, Taiwan
- Guangzhou, China
- Petaling Jaya, Malaysia
- Singapore
- Bangalore, India
- Sydney, Australia



[tainstruments.com](http://tainstruments.com)