



DISCOVERY HYBRID RHEOMETER

The **Discovery Hybrid Rheometer**

The **Most Powerful** and **Versatile Rheometer**

for your laboratory



The Discovery Hybrid Rheometer (DHR) features powerful new technologies from the world leader in rheological measurements. Our new hybrid technology combines a **patented magnetic bearing, advanced drag cup motor, Force Rebalance Transducer (FRT), and new patent-pending optical encoder dual reader**, and **True Position Sensor (TPS)** to deliver sensitive, accurate, and reproducible measurements.

The DHR has improved every performance specification and delivers unrivaled true strain, strain rate, stress control, and normal force accuracy. The DHR also features our most popular TA innovations including patented Smart Swap™ geometries and Smart Swap™ temperature systems.

DISCOVER Powerful New Innovations

The next generation of strain measurements Optical Encoder Dual Reader

All DHR systems feature optical encoders for high-resolution displacement measurements. The HR-3 features a patent-pending optical encoder with dual reader. This new technology provides **ultra-high displacement resolution** of two nanoradians, reduces noise, and enhances phase angle measurements. The benefit is better data and higher sensitivity when running challenging materials over a broad range of conditions, or even extreme conditions.

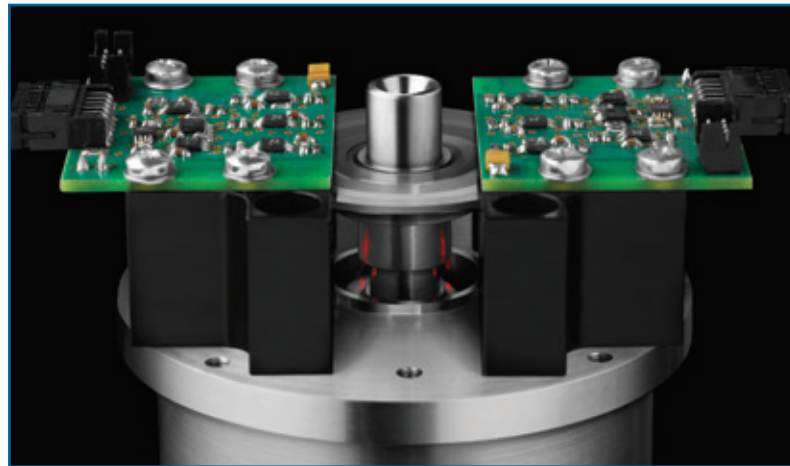

Normal Force Rebalance Transducer (FRT)

The TA Instruments ARES-G2 Force Rebalance Transducer has long been the industry standard for normal force measurements. This FRT technology is now part of the Discovery Hybrid Rheometer. Competitive strain gauge and capacitive sensors rely on physical movement of the device to sense a force. This can result in measurement error. An FRT provides the most accurate normal force measurement because the linear motor is driven to maintain zero deflection. The FRT and the patented magnetic bearing technologies enable **axial Dynamic Mechanical Analysis (DMA) capabilities on every DHR**, permitting amplitude-controlled oscillatory deformation in the axial direction. Now in addition to the most sensitive and accurate rotational shear measurements, the DHR can deliver accurate linear DMA data as well without the installation of external components.

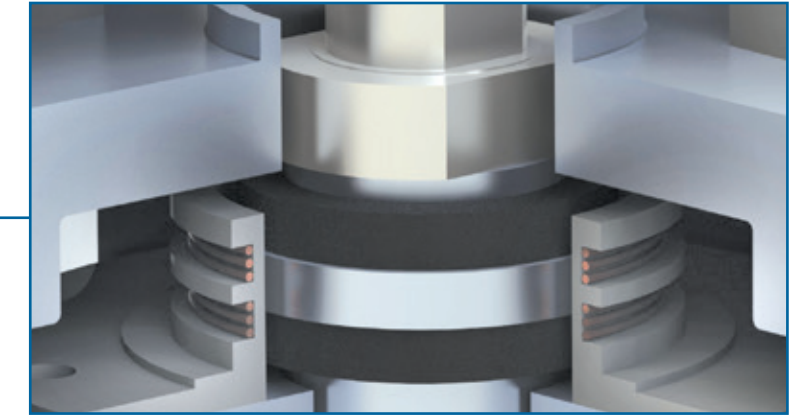

Second Generation Magnetic Thrust Bearing

The DHR is the **only commercial rheometer with a magnetic thrust bearing** and our second generation patented design offers improved low torque performance and mapping stability. The low-end torque performance of any rheometer depends on bearing friction which results in residual torques. The DHR magnetic bearing has a gap 250 times larger than competitive air-bearing designs, and thus no drag from pressurized air flow. The result is 70% less friction enabling the DHR motor to measure 0.5 nN.m of torque. The magnetic bearing design is inherently robust and not susceptible to contamination. (Patent #'s 7,137,290 and 7,017,393)



New True Position Sensor (TPS)

The DHR includes a patented True Position Sensor (TPS) for true gap accuracy. The TPS is a high-resolution linear position sensor that measures and **compensates thermal expansion effects in real time**, ensuring the most accurate data. Unlike competitive devices, the TPS eliminates thermal expansion errors without the need for special high inertia iron core geometries and environmental systems.

The TPS works with all Smart Swap™ geometries and Smart Swap™ environmental systems. (Patent # 9,534,996)

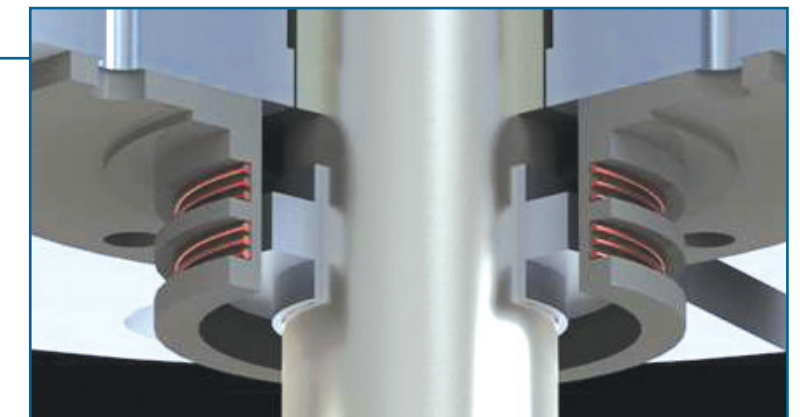

Advanced Drag Cup Motor

The DHR incorporates our redesigned and patented drag cup motor, with digital current control for more stable torque output and minimal drift. The DHR motor provides extremely smooth acceleration, the fastest step strain and step rate response, and keeps inertia, temperature, and friction to an absolute minimum. There are significant performance advantages of TA Instruments' drag cup motor design compared to other drag cup designs and to the synchronous electrically commutated (EC) motors. **Scientists will see significant benefits from the TA motor design in the quality and reproducibility of their sample data.**

(Patent # 6,798,099)

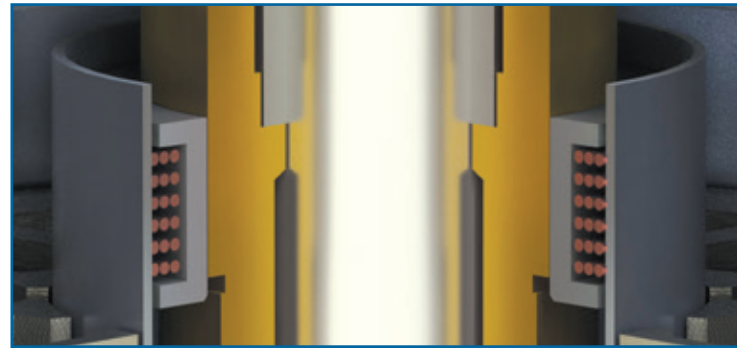

Radial Air Bearings

The DHR is designed with two porous carbon radial air bearings positioned along the length of the shaft providing high stiffness and low friction support in the radial direction. This design is ideal for the testing of high stiffness samples, such as solids in torsion as well as soft solids and low viscosity fluids.

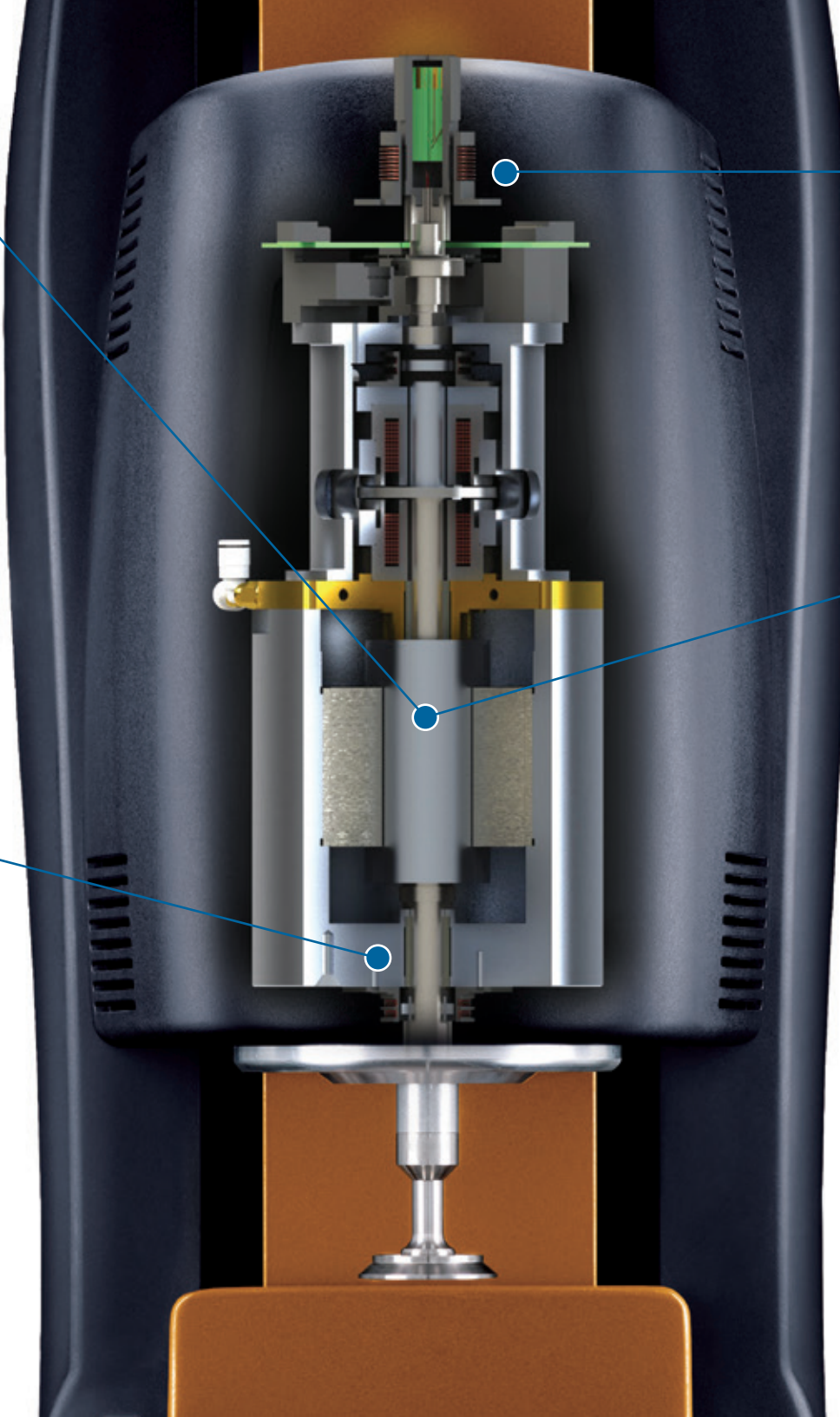
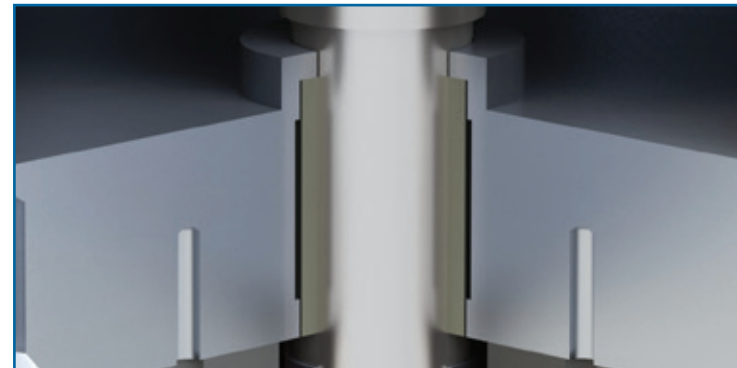

Active Temperature Control (ATC)

Precise control of upper and lower plate temperatures is vital for the most accurate rheological measurements. The DHR features patented ATC technology that enables wireless temperature measurements across an air gap for significant temperature control advantages over traditional non-contact systems. Only with ATC is the actual upper plate temperature known rather than inferred, making real-time control of both plates possible. The benefits are **faster temperature response, true temperature ramp capability, and elimination of complex calibration procedures and offset tables.**

(Patent # 6,931,915)

TA Drag Cup Motor Features

Benefits

Low moment of inertia with less correction before, during, or after the measurement

- Accurate data to higher frequencies on low viscosity fluids during or after the measurement
- Faster transient response because less mass to overcome
- Purer information for LAOS measurements

No permanent magnets

- No interference from external metal such as neighboring instruments on bench, or the rheometer frame itself
- Metal geometries can be made shorter for less compliance
- Residual torque maps are independent of gap settings

True open loop stress control

- Absolutely TRUE stress control
- Best creep and recovery measurements available
- Can measure zero rate

Digital current control

- No range switching for completely seamless torque over the entire torque range

Trim Lock

- Electronic bearing lock for sample trimming

Patented non-contact temp sensor and integrated active motor cooling

- Sensor provides temperature corrected torque for the most accurate torque control and measurements
- Time at max torque is not limited by motor temperature, as in competitive designs

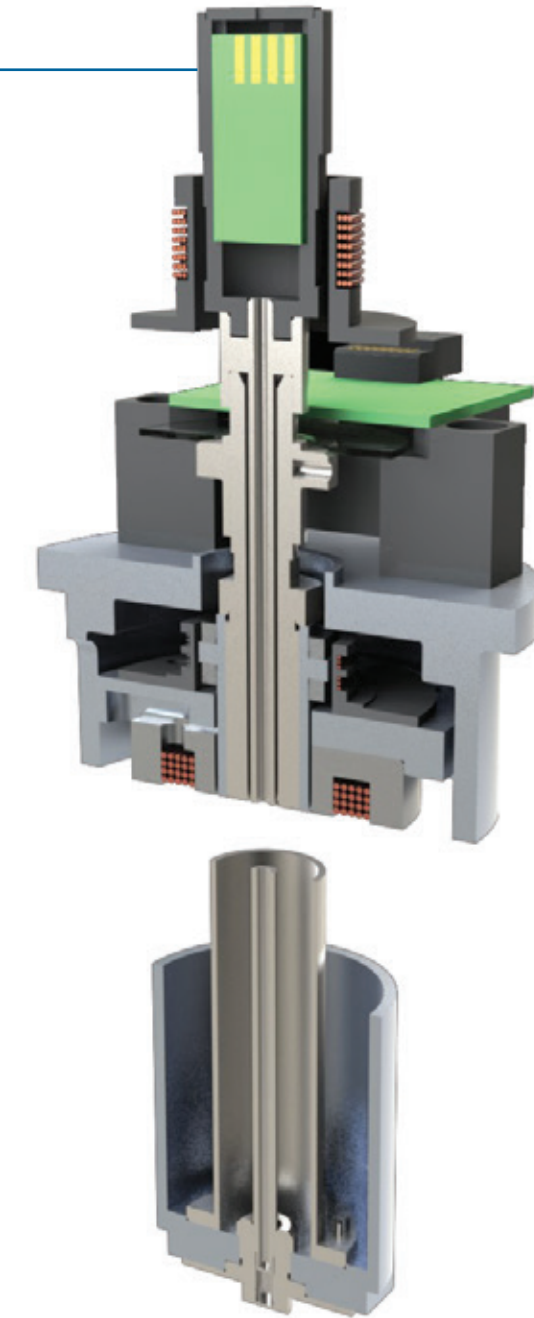

DISCOVER Innovations Designed for Ease of Use and Accuracy

Smart Swap™ Geometries

The DHR features our patented Smart Swap™ geometries with automatic detection. Smart Swap™ geometries include an integrated magnetic cylinder that stores unique geometry information. When attached, the information is automatically read and the software is configured with appropriate parameters (type, dimension, material).
(Patent # 6,952,950)



Smart Swap™ Temperature Systems and Accessories

Only TA Instruments offers the convenience and versatility of Smart Swap™ temperature control options and accessories. Smart Swap™ options are attached to the instrument on its unique magnetic base, making it effortless to switch between accessories. Once attached, the instrument automatically detects and configures the system for operation.



Intuitive Touch Keypad

A robust, intuitive keypad inspires simple interaction by placing the most important rheometer functions at your fingertips. Available functions include: gap zero, trim gap, go to gap, raise and lower head, start and stop tests. The tactile keypad employs a rugged, sealed design that resists even the most aggressive solvents, providing worry-free operation in any environment.



Single-Piece Aluminum - Casting and Linear Ball Slide

The DHR is built on a new single-piece aluminum casting with the rheometer head attached to the casting by a rugged linear ball slide. This configuration reduces torsional and axial compliance by 60% over traditional designs. A micro stepper motor and linear optical encoder ensure precision positioning of the geometry with a resolution of 0.02 microns. The open design provides ease of access and ample space for sample loading and trimming.

Display

The color display reports a variety of real-time data at the test station to facilitate sample loading, and provides system information during experiments.

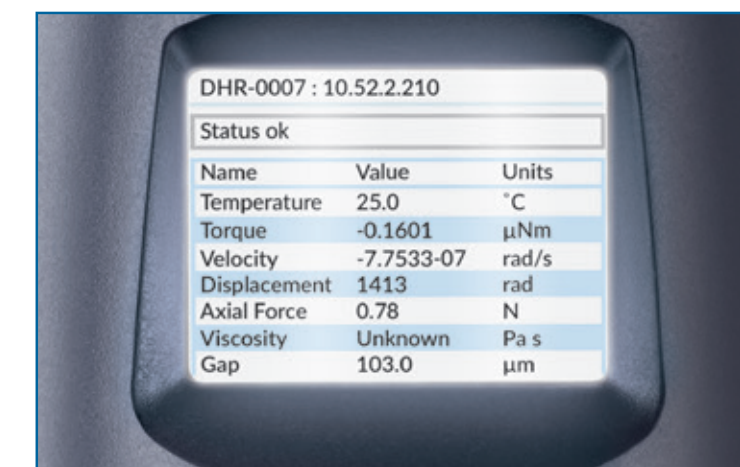

All DHR temperature systems and accessories are designed with superior performance and ease-of-use in mind. Only TA Instruments' DHR offers the convenience and versatility of Smart Swap™ geometries, temperature systems, and accessories. Smart Swap™ technologies provide **fast and easy interchanging of accessories** with automatic detection and configuration of the rheometer for operation.

The **World's** most **Versatile** platform for **Rheological Measurements**



Peltier Plate

Our best-selling temperature control system is the Peltier Plate. It can handle the widest range of material applications with standard, stepped and disposable models. Temperature range is -40 °C to 200 °C with controllable heating rates of up to 20 °C/min. Peltier Plate accessories include evaporation blocking, thermal covers, purge covers, and immersion capability. It is the **highest performing, most versatile, and best accessorized Peltier Plate temperature system on the market.**

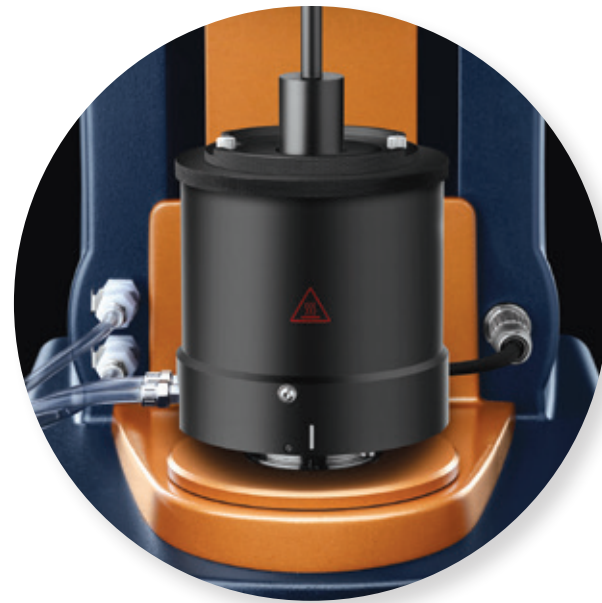

Peltier Concentric Cylinder

The DHR patented Peltier Concentric Cylinder combines the convenience of Smart Swap™ and Peltier heating technology with a wide variety of cup and rotor geometries. Concentric cylinder geometries are commonly used for testing low viscosity fluids, dispersions or any liquids that are pourable into a cup. Convenient Peltier technology provides stable and responsive temperature control from -20 °C to 150 °C.

(Patent # 6,588,254)

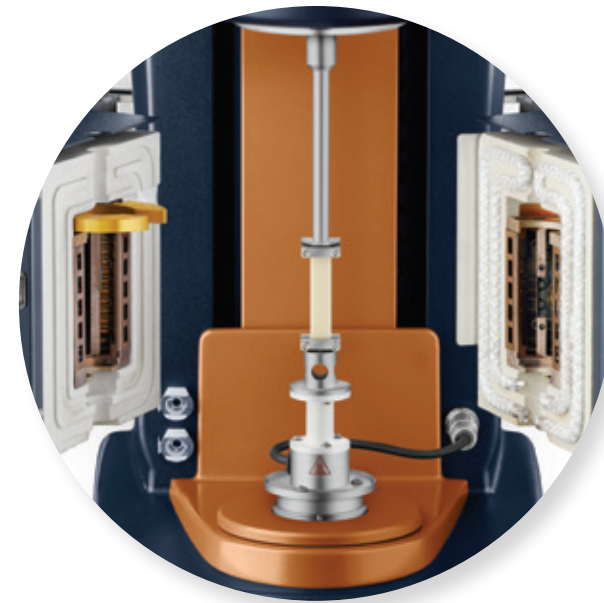

Environmental Test Chamber, ETC

The ETC is a high temperature Smart Swap™ oven that uses controlled convection/radiant heating. Temperature range is -160 °C to 600 °C with heating rates up to 60 °C/min, providing fast response and temperature stability. The ETC is a very popular option for polymer applications and can be used with parallel plate, cone and plate, disposable plate, rectangular torsion, and **axial DMA clamps for solids**. Image capture and camera viewing is optionally available over the entire temperature range.

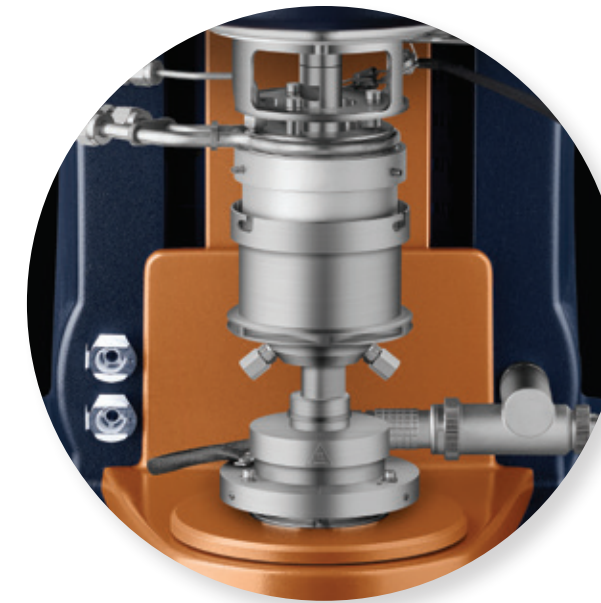

Electrically Heated Plates, EHP

Provides active heating and cooling of cone and parallel plate geometries to a maximum temperature of 400 °C. Optional Gas Cooling Accessory extends the temperature to -70 °C. The EHP is ideal for high-throughput polymer sample testing. With patented Active Temperature Control, ATC, it is the only EHP system capable of direct temperature control of the upper and lower plates. Standard and disposable systems are available for polymer melt and thermosetting materials. Camera viewing option available.

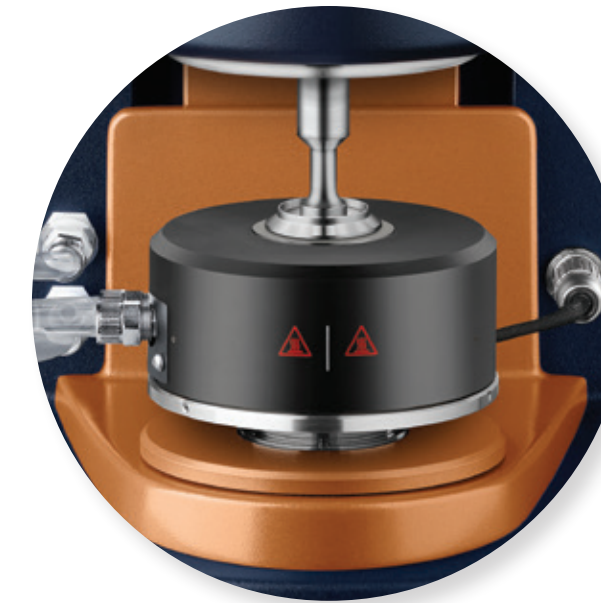

New Dual Stage Peltier Plate

The New Dual Stage Peltier Plate is another first from the innovator of Peltier Plate technology. The unique design uses a stacked Peltier element approach. The benefit is unprecedented low temperature performance providing a continuous temperature range of -45 °C to 200 °C with water circulating at a single heat sink temperature. The Dual Stage Peltier is the perfect choice for applications requiring sub-ambient temperature control.

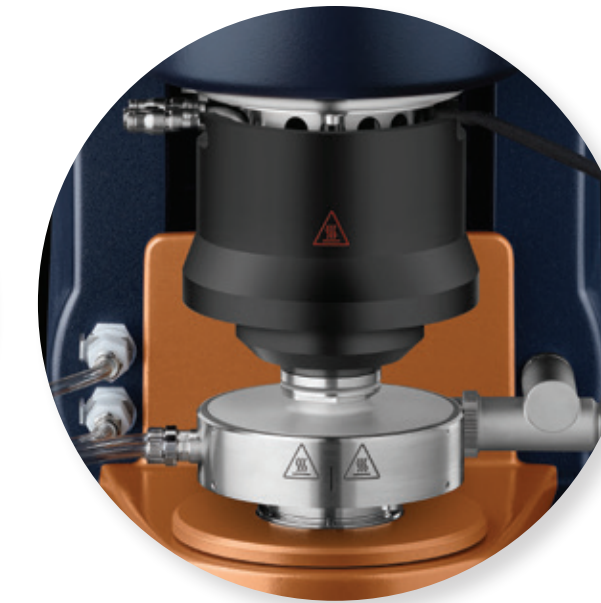

Upper Heated Plate, UHP

The UHP is a temperature option designed for use with Peltier plates to help minimize vertical temperature gradients. The UHP is compatible with all Peltier plate models and provides both upper plate temperature control and purge gas environment. The UHP has a maximum temperature of 150 °C and the lower temperature can be extended using liquid or gas cooling options. The UHP is the only non-contact temperature system to feature patented **Active Temperature Control for direct measurement and control of the upper plate temperature.**



Electrically Heated Concentric Cylinder

The new Electrically Heated Concentric Cylinder (EHC) system extends the temperature of concentric cylinder measurements to 300 °C. Efficient electrical heaters and optimized heat transfer ensure the most accurate and uniform temperature control. The EHC is compatible with a wide variety of concentric cylinder accessories, including the popular Pressure Cell.



Dry Asphalt and Asphalt Submersion Systems

TA asphalt systems meet or exceed SHRP, ASTM, and AASHTO requirements and include 8 and 25 mm parallel plates and sample molds. The Dry Asphalt System combines our superior Upper Heated Plate with a unique lower stepped Peltier Plate. Flexible cooling options include Peltier, Vortex, and water circulator cooling. The Asphalt Submersion Cell employs the classic approach of temperature control by fully submersing the sample in circulating water.



Air Chiller Systems (ACS-2 and ACS-3)

The new Air Chiller Systems are unique gas flow cooling systems that enable temperature control of the Environmental Test Chamber without the use of liquid nitrogen. Equipped with multi-stage cascading compressors, the ACS-2 and ACS-3 permit operation of the ETC at temperatures as low as -50 °C and -85 °C, respectively. Utilizing compressed air, the Air Chiller Systems can help **eliminate or reduce liquid nitrogen usage from any laboratory** and offer an incredible return on investment.



Relative Humidity Accessory

The DHR-RH Accessory is a new environmental system that enables accurate control of sample temperature and relative humidity. The accessory employs a custom-designed humidity and temperature chamber that is optimized for rheological measurements and provides stable, reliable control of temperature and humidity over a wide range of operating conditions. A wide variety of test geometries are available, including geometries specially designed to study true humidity-dependent rheology.

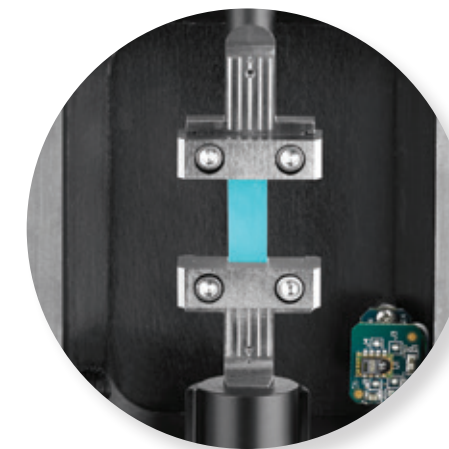

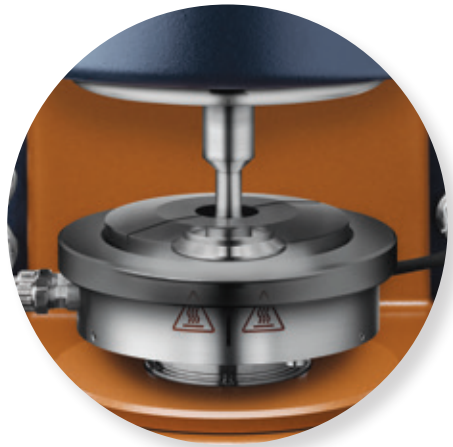

Solvent Trap/ Evaporation Blocking System

Solvent Trap cover and Solvent Trap geometries together create a thermally stable vapor barrier, virtually eliminating any solvent loss during rheological experiments and improving temperature uniformity.

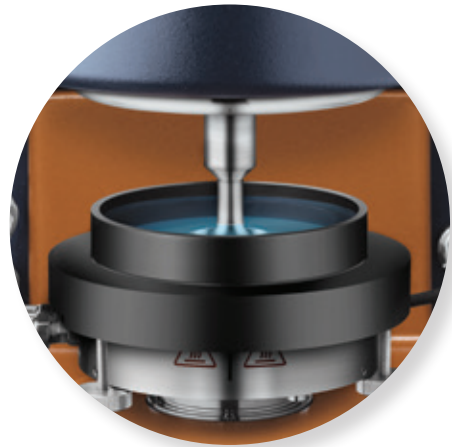

Peltier Immersion Ring

The Peltier Plate Immersion Ring allows samples to be measured while fully immersed in a fluid. The immersion ring is compatible with all Peltier Plate models and is easily attached to the top of the Peltier Plate. A rubber ring provides the fluid seal. This option is ideal for studying the properties of hydrogels.



Insulating Thermal Covers

Thermal Insulation Covers are constructed of an anodized aluminum core surrounded by an insulating exterior. The aluminum core conducts heat to the upper geometry, providing uniform temperature throughout the sample. Insulated Solvent Traps offer the added benefit of preventing evaporation.

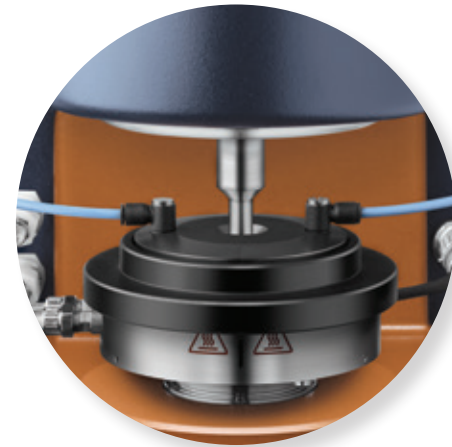

Purge Gas Cover

The Purge Gas Cover is a hard-anodized aluminum two-piece split cover with 4 mm diameter compression fittings. This cover can be used to purge the sample area with dry nitrogen gas to prevent condensation below room temperature, or purge with humidified gas to prevent sample drying.

New Advanced Peltier Plate

The new Advanced Peltier Plate **combines ultimate flexibility with exceptional temperature performance** in a single Peltier Plate temperature system designed to cover the widest range of applications. The unique Quick Change Plate system provides the ability to easily attach lower plates of different materials and surface finishes, disposable plates for testing curing materials, and an Immersion Cup for characterizing materials in a fluid environment.

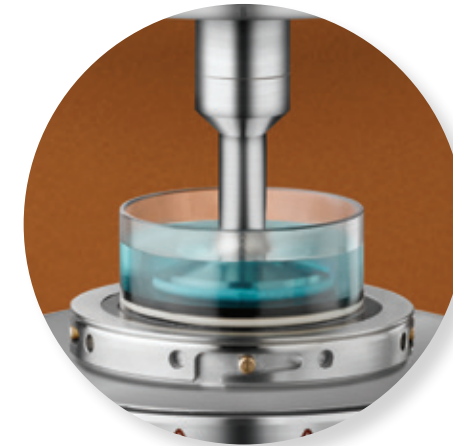
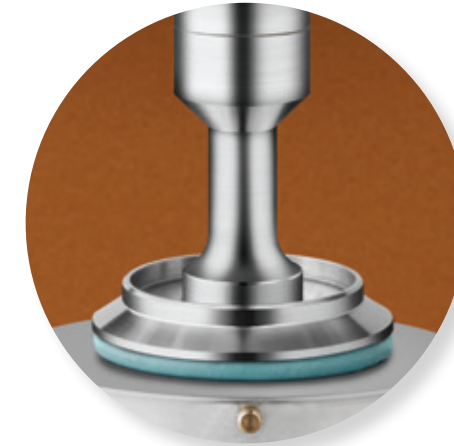

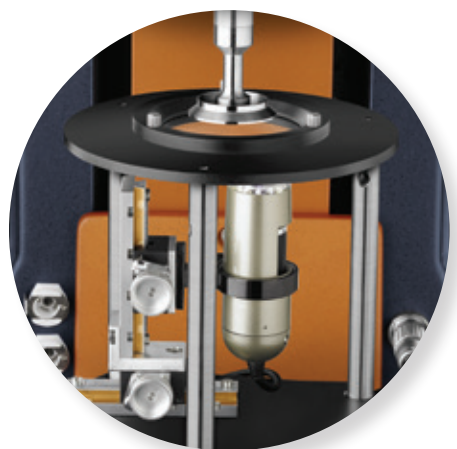

Optics Plate Accessory, OPA

The OPA is an open optical system that permits basic visualization of sample structure during rheological experiments, revealing important insights about material behavior under flow. An open platform with a borosilicate glass plate provides a transparent optical path through which the sample can be viewed directly. This enhances the understanding of a range of materials, especially suspensions and emulsions.

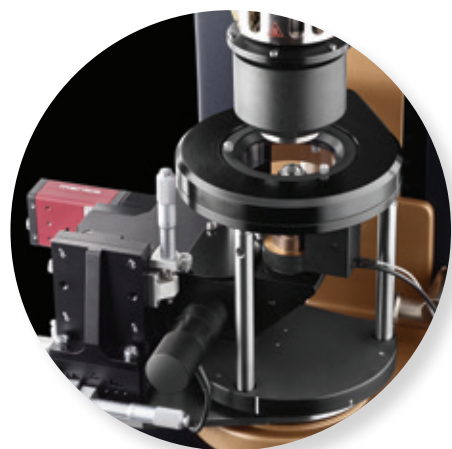

Modular Microscope Accessory, MMA

The Modular Microscope Accessory (MMA) enables complete flow visualization with simultaneous rheological measurements. A high-resolution camera collects images at up to 90 fps coupled with industry-standard microscope objectives that provide magnification up to 100x. Illumination from a blue-light LED can be coupled with a cross-polarizer or dichroic splitter for selective illumination or fluorescence microscopy.

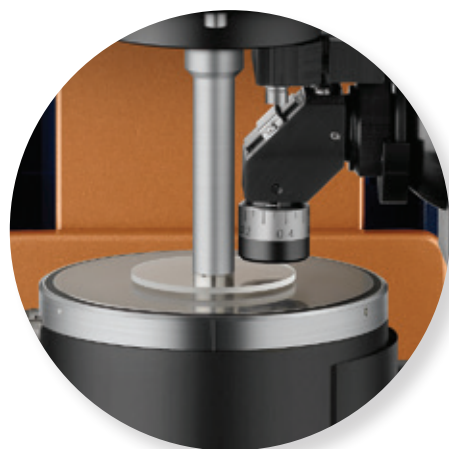

Small Angle Light Scattering, SALS

The SALS option provides simultaneous rheological and structural information such as particle size, shape, orientation and spatial distribution. The accessory features patented Peltier Plate temperature control, scattering angle (θ) range of 6° to 26.8° , scattering vector range (q) of $1.38 \mu\text{m}^{-1}$ to $6.11 \mu\text{m}^{-1}$. Length scale range is $1.0 \mu\text{m}$ to about $4.6 \mu\text{m}$.
(Patent # 7,500,385)

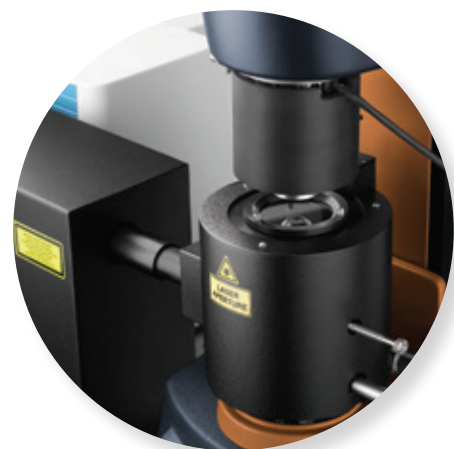

Rheo-Raman Accessory

The new Rheo-Raman Accessory allows for simultaneous collection of Raman spectroscopy data during rheology experiments. Raman spectroscopy is a technique that provides critical information about molecular structure and bonding and can elucidate intermolecular interactions of pure components and mixtures. The Rheo-Raman Accessory from TA Instruments integrates with the iXR Raman Spectrometer™ from Thermo Fisher Scientific™ to provide a turnkey, safe system with Class 1 laser certification.

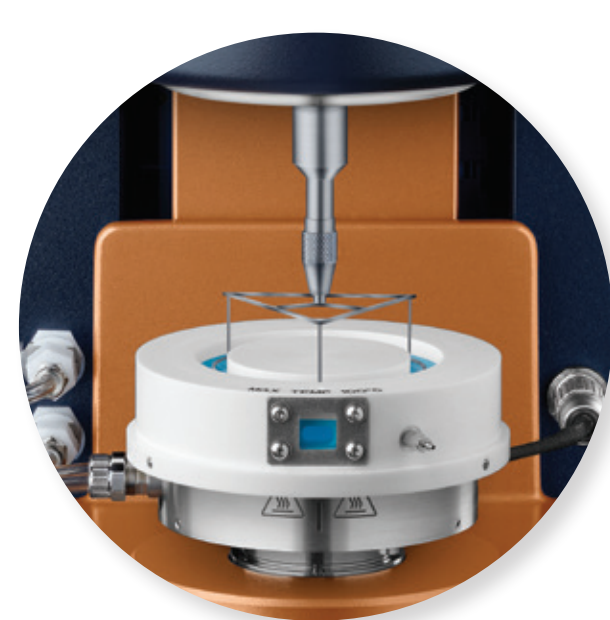

Interfacial Rheology: Double Wall Ring and Double Wall Du Noüy Ring

Patented technologies allow the characterization of interfacial rheology using specialized geometries to measure the viscosity and viscoelastic properties at two-dimensional liquid-air and liquid-liquid interfaces. The Well-defined flows and negligible sub-phase contributions in the Double Wall Ring (DWR) and Double Wall du Noüy Ring (DDR) make these tools the preferred choice for sensitive measurements of interfacial rheology. In TA Instruments interfacial rheology systems, the sample is contained in a Delrin® trough with measuring geometries made of Platinum-Iridium. These materials are selected for their inert chemistry and ease of cleaning. The choice of different interfacial rheology options gives you the greatest flexibility in choosing the appropriate geometry for your application.
(Patent # 7,926,326)

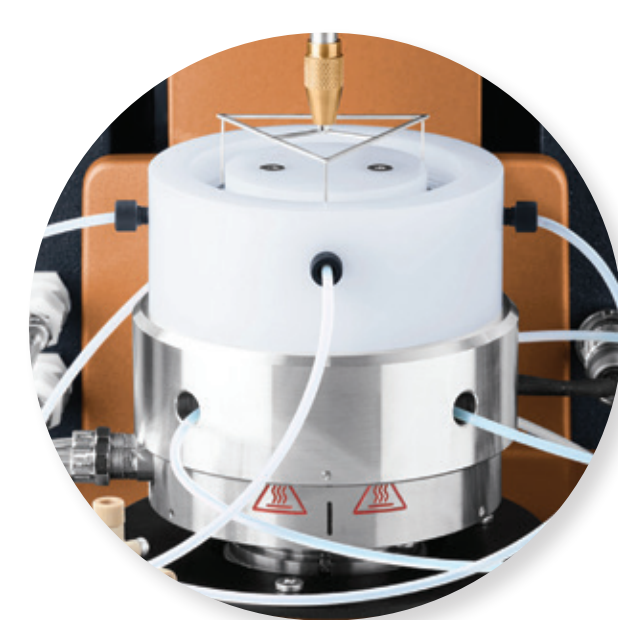
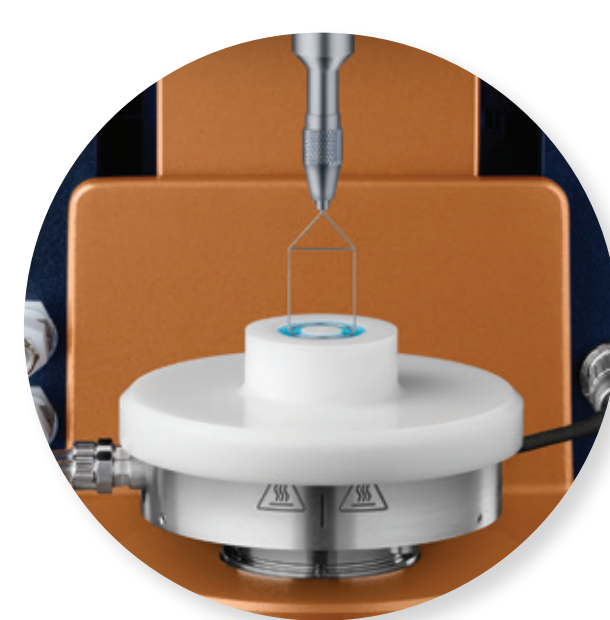

Interfacial Exchange Cell

The new Interfacial Exchange Cell expands TA Instruments' patented offerings for interfacial rheology by providing the ability to directly manipulate the composition of the lower liquid layer (subphase) during rheological measurements. This unique capability enables the characterization of the interfacial response to a modified subphase composition, opening possibilities for quantifying the effects of changes in pH, salt, or drug concentration, or the introduction of new proteins, surfactants, or other active ingredients.



ETC Geometry Accessory Kits

The kits feature standard geometries configured for testing thermoplastics and rubber, thermosetting and other curing systems, pressure-sensitive adhesives and asphalt binders. A wide variety of stainless geometries of various diameters and cone angles, and disposable plates are also available to fully accessorize the temperature system.

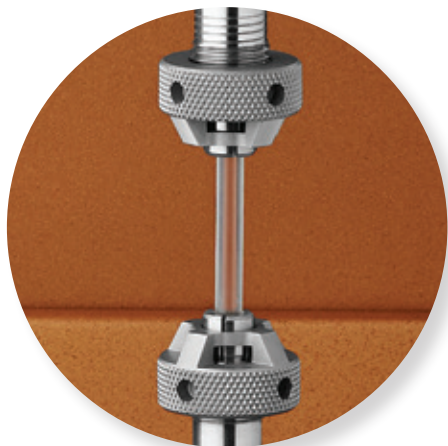

ETC Torsion Clamp Kits

The Torsion Clamp Kits offer an easy way to test solid rectangular or cylindrical samples under shear deformation on the rheometer. This type of torsional testing can be used to study transition temperatures and evaluate blend compatibility in multi-component polymeric samples.

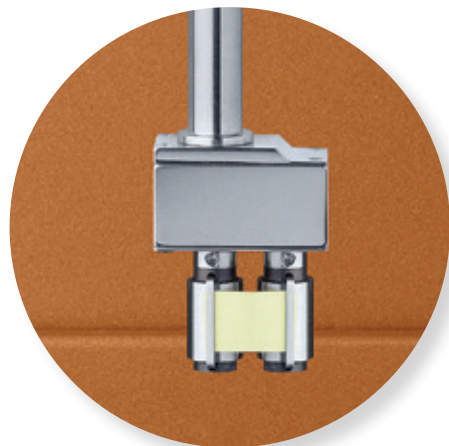

SER3 Universal Testing Platform

The SER3 is a universal testing platform to perform extensional rheology measurements and a range of physical material property measurements such as tensile, peel, tear and friction on small solid samples.

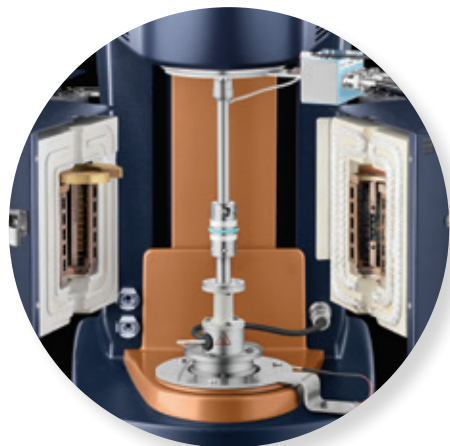

Dielectric Analysis

Dielectric analysis is a powerful technique that measures electrical properties such as capacitance and conductance. It can be used to characterize polar materials such as PVC, PVDF, PMMA, and PVA, phase separating systems, and monitor curing kinetics in materials such as epoxy and urethane systems. Dielectric analysis can measure at frequencies as high as 2MHz, well beyond traditional mechanical limits.

Dynamic Mechanical Analysis (DMA)

Backed by over four decades of TA Instruments' expertise in rotational rheology and linear DMA measurements, the Discovery Hybrid Rheometer's DMA mode adds a new dimension for testing solid and soft-solid materials. Now, in addition to the most sensitive and accurate rotational shear measurements, the DHR can deliver accurate **linear Dynamic Mechanical Analysis (DMA) data**. Compatible with the ETC Oven and Relative Humidity Accessory, the DMA capability is available in: film tension, three-point bend, cantilever, and compression. Axial DMA complements solid torsion testing by providing a direct measure of the modulus of elasticity, or Young's Modulus (E). The new DMA mode is ideal for identifying a material's transition temperatures and provides reliable measurements over the instrument's full range of temperatures.

The axial DMA capability is enabled by the DHR's active Force Rebalance Transducer (FRT) and patented magnetic bearing technologies that permit amplitude-controlled measurements in the axial direction. During DMA measurements, the position of the active bearing is directly controlled to impose oscillatory linear deformation on the sample. Competitive instruments employing air bearings and passive normal force measurements are inherently incapable of such measurements due to design limitations. Powered by the **FRT technology available on all DHR models**, the DMA mode does not require the installation of external components, so it is **always quick and easy to get great data!**

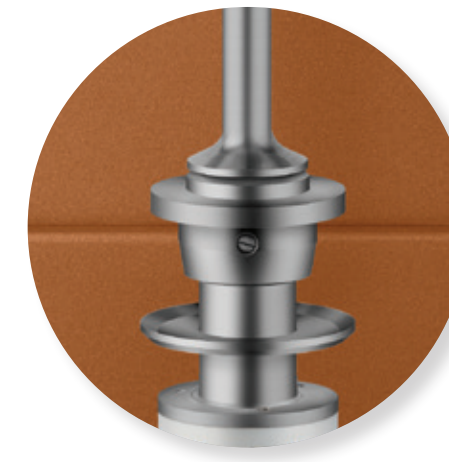
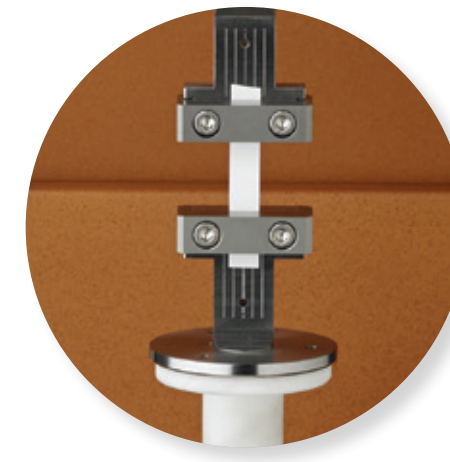
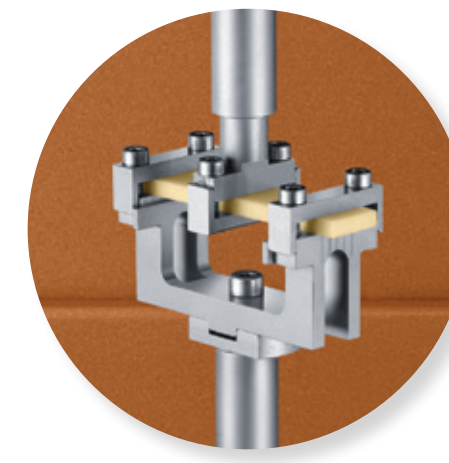
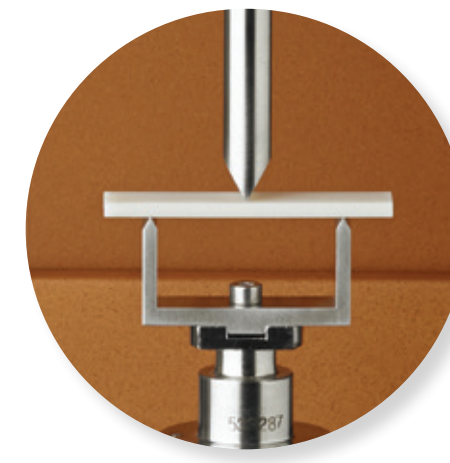



Pressure Cell

An optional sealed vessel for studying the effect of pressure on rheological properties or materials that volatilize under atmospheric pressure. Can be used to a pressure up to 138 bar (2,000 psi) and to a maximum temperature of 300 °C.



Starch Pasting Cell

The Starch Pasting Cell (SPC) is a powerful and accurate tool for rheological characterization of the gelatinization process and final properties of starch products or basic characterization of many other highly unstable materials.

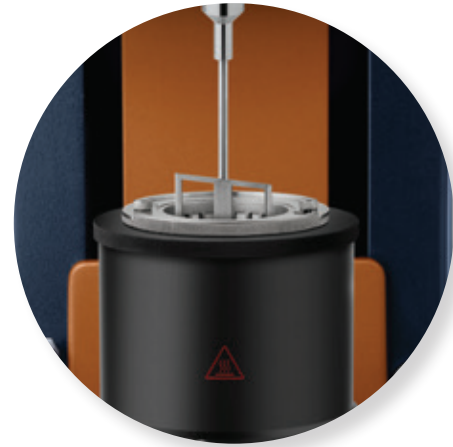

Building Materials Cell

The Building Materials Cell is a specially designed, abrasion-resistant and durable concentric cylinder cup and rotor for testing samples with large particles such as concrete slurries and mixes. The paddle type rotor, slotted cage, and the large diameter cup promote adequate sample mixing while preventing sample slip at both the cup and rotor surfaces.

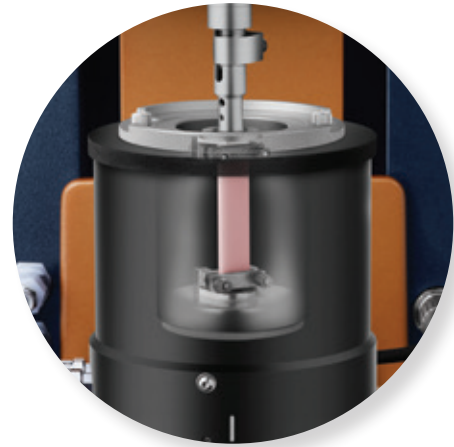

Torsion Immersion Cell

The Torsion Immersion Cell allows rectangular bar-shaped samples to be clamped and characterized while immersed in a temperature-controlled fluid. The resulting change in mechanical properties, caused by swelling or plasticizing, can be analyzed in oscillatory experiments.

Tribo-Rheometry

The new Tribo-Rheometry Accessory enables measurement of the coefficient of friction between two solid surfaces under dry or lubricated conditions. The unique self-aligning design ensures uniform solid-solid contact and axial force distribution under all conditions. A **modular set of standard and novel geometries** offers a choice of different contact profiles and direct simulation of end-use conditions.

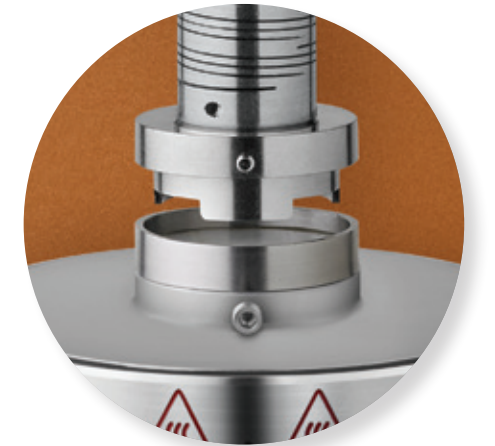
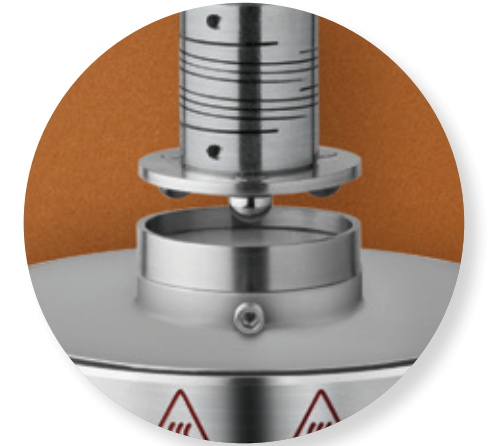
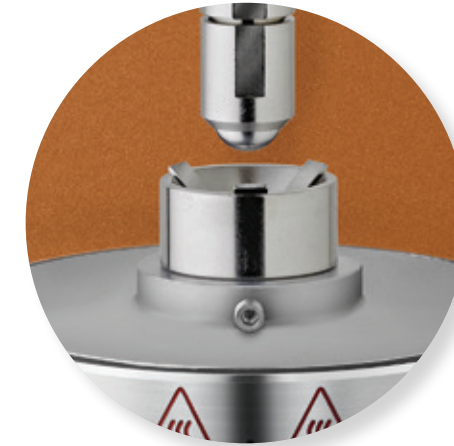

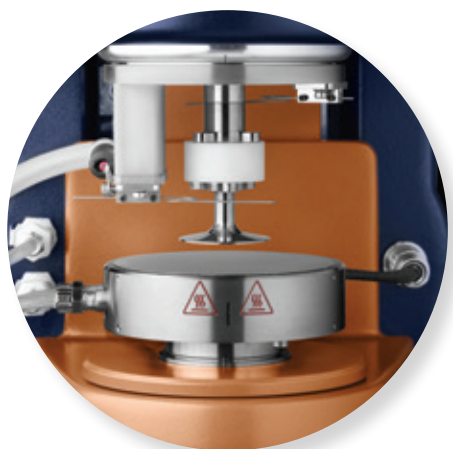

Electrorheology

Allows characterization of electro-rheological fluids with a voltage up to 4000 V in both DC and AC modes. Features parallel plate and concentric cylinder geometries and a maximum temperature of 200 °C. Flexible programmable voltage profiles such as step, ramp, sine, and triangle wave functions as well as functions with DC offsets.

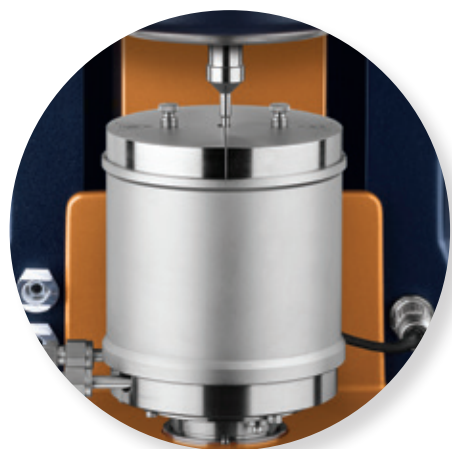

Magneto-Rheology

The new MR Accessory enables the complete characterization of magneto-rheological fluids under the influence of a controlled field. Applied fields up to 1 T and a sample temperature range of -10 °C to 170 °C make the MR Accessory ideal for all studies of MR fluids and ferrofluids.

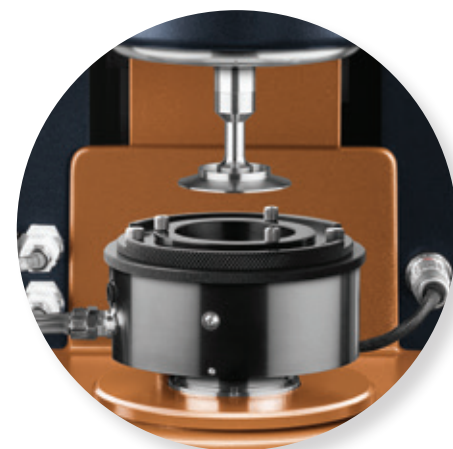

Immobilization Cell

The new Immobilization Cell Accessory permits the characterization of drying, retention, and immobilization kinetics of paints, coatings and slurries. Solvent is dewatered from the sample through a paper substrate affixed to a perforated lower plate under controlled temperature and vacuum. Rheological changes in the sample during this immobilization process are simultaneously quantified through an oscillatory time sweep test with controlled axial force.



Generic Container Holder

The Generic Container Holder is a Smart Swap™ option that can hold any container with an outer diameter of up to 80 mm for characterizing materials with rotors. This allows for quick off-the-shelf evaluation of materials, such as paints and varnishes, creams, pasta sauce, etc., without creating large shearing from sample loading. It also is an excellent platform for beakers or jacketed beakers.



UV Curing Accessories

Two Smart Swap™ accessories for rheological characterization of UV-curable materials are available for the DHR-3 and DHR-2 rheometers. One accessory uses a light guide and reflecting mirror assembly to transfer UV radiation from a high-pressure mercury light source. The second accessory uses self-contained light emitting diodes (LED) arrays featuring primary peaks of 365 nm and 455 nm. Both systems are compatible with optional disposable plates and temperature control up to 150 °C.

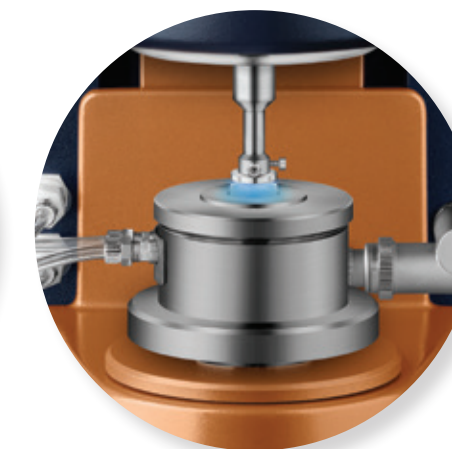

Technical Specifications

Specification	HR-3	HR-2	HR-1
Bearing Type, Thrust	Magnetic	Magnetic	Magnetic
Bearing Type, Radial	Porous Carbon	Porous Carbon	Porous Carbon
Motor Design	Drag Cup	Drag Cup	Drag Cup
Minimum Torque (nN.m) Oscillation	0.5	2	10
Minimum Torque (nN.m) Steady Shear	5	10	20
Maximum Torque (mN.m)	200	200	150
Torque Resolution (nN.m)	0.05	0.1	0.1
Minimum Frequency (Hz)	1.0E-07	1.0E-07	1.0E-07
Maximum Frequency (Hz)	100	100	100
Minimum Angular Velocity ^[1] (rad/s)	0	0	0
Maximum Angular Velocity (rad/s)	300	300	300
Displacement Transducer	Optical Encoder	Optical Encoder	Optical Encoder
Optical Encoder Dual Reader	Standard	N/A	N/A
Displacement Resolution (nrad)	2	10	10
Step Time, Strain ^[2] (ms)	15	15	15
Step Time, Rate ^[2] (ms)	5	5	5
Normal/Axial Force Transducer	FRT	FRT	FRT
Maximum Normal Force (N)	50	50	50
Normal Force Sensitivity (N)	0.005	0.005	0.01
Normal Force Resolution (mN)	0.5	0.5	1

[1] Zero in controlled stress mode. Controlled rate mode depends on duration of point being measured and sampling time.

[2] Results at 99% of commanded value

DMA Mode

Specifications	
Motor Control	Force Rebalance Transducer
Minimum Force in Oscillation	0.003 N
Maximum Axial Force	50 N
Minimum Displacement in Oscillation	0.01 μm
Maximum Displacement in Oscillation	100 μm
Axial Frequency Range	6×10^5 rad/s to 100 rad/s (10^5 Hz to 16 Hz)

Instrument Features

- Patented Ultra-low Inertia Drag Cup Motor
- Patented Second Generation Magnetic Bearing
- High-Resolution Optical Encoder
- Optical Encoder Dual Reader (Patent Pending)^[1]
- Normal Force Rebalance Transducer (FRT)
- Patented True Position Sensor
- Nano-Torque Motor Control
- Superior True Stress, Strain, and Strain Rate Control
- Direct Strain Oscillation^[2]
- Thrust & Dual-Radial Bearing Design
- Ultra-low Compliance Single-Piece Frame
- Heat and Vibration Isolated Electronics Design
- Patented Smart Swap™ Geometries
- Original Smart Swap™ Temperature Systems
- Superior Peltier Technology
- Patented Heat Spreader Technology
- Patented Active Temperature Control
- Color Display
- Intuitive Touch Keypad
- Patented Traceable Torque Calibration

[1] Discovery HR-3 model only

[2] Discovery HR-2 and HR-3 models only



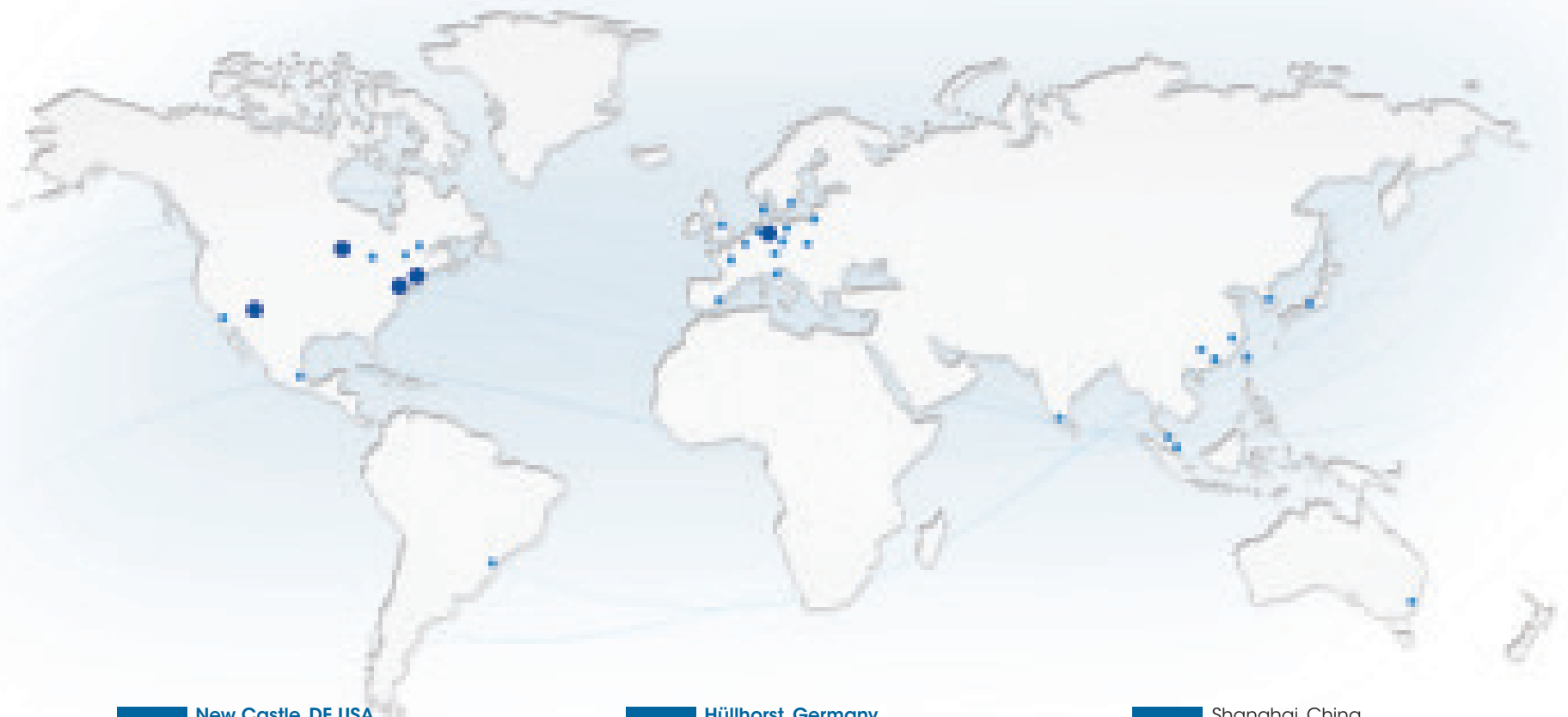

AMERICAS

New Castle, DE USA

Lindon, UT USA

Wakefield, MA USA

Eden Prairie, MN USA

Chicago, IL USA

Costa Mesa, CA USA

Montreal, Canada

Toronto, Canada

Mexico City, Mexico

São Paulo, Brazil

EUROPE

Hüllhorst, Germany

Bochum, Germany

Eschborn, Germany

Wetzlar, Germany

Elstree, United Kingdom

Brussels, Belgium

Etten-Leur, Netherlands

Paris, France

Barcelona, Spain

Milano, Italy

Warsaw, Poland

Prague, Czech Republic

Sollentuna, Sweden

Copenhagen, Denmark

ASIA & AUSTRALIA

Shanghai, China

Beijing, China

Tokyo, Japan

Seoul, South Korea

Taipei, Taiwan

Guangzhou, China

Petaling Jaya, Malaysia

Singapore

Bangalore, India

Sydney, Australia



tainstruments.com