



MICROCALORIMETRY: ITC & DSC



## Microcalorimetry

Isothermal titration calorimetry (ITC) and differential scanning calorimetry (DSC) are powerful analytical techniques for in-depth characterization of molecular binding events and structural stability. Thermodynamic binding signatures not only reveal the strength of a binding event, but the specific or nonspecific driving forces involved. Structural stability profiles from DSC reveal strengths and weaknesses in higher order structure and define the behavior of individual domains and their interactions. The TA Instruments Affinity ITC, Nano ITC and Nano DSC provide the performance, reliability and ease-of-use required for the most demanding applications in drug discovery, protein-protein interactions, structure-function characterization and more.



## AFFINITY ITC and ITC AUTO | ISOTHERMAL TITRATION CALORIMETER

The Affinity ITC and ITC Auto are designed for the most challenging life science laboratory environments that require high sensitivity, high productivity and the most advanced ITC technologies. The Affinity ITC brings advanced engineering to all critical aspects of the measurement ensuring the highest quality ITC data.

### Features and Benefits:

- AccuShot™ delivers the titrant to the right location for the best mixing
- FlexSpin™ provides innovative slow speed stirring, efficient mixing and highest sensitivity
- Fully automated, user-selectable system cleaning routines eliminate run-to-run contamination
- Intelligent Hardware Positioning for precise reliable injections
- Solid-state active heating and cooling for true isothermal temperature control
- Choice of standard volume (1.0 mL) or low volume cells (190  $\mu$ L)
- Industry proven 96-well, temperature-controlled liquid handling autosampler. Autosampler can be included with initial purchase or added at a later date
- Powerful ITCRun and NanoAnalyze for the most comprehensive suite of tools for method optimization, model fitting, batch analysis, graphing and data export.

TA Instruments has perfected what others have attempted. The Affinity ITC is a powerful tool for measuring a wide variety of molecular interactions. It provides both inexperienced and advanced ITC users the highest confidence in generating superior ITC data.

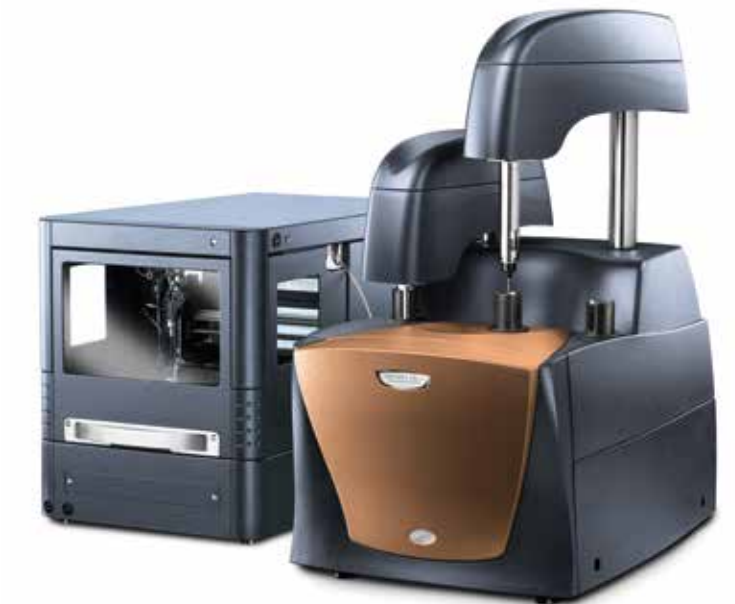

**The Affinity ITC cell is optimized in shape, material, and volume to provide the greatest measurement accuracy over the widest range of sample chemistries.**

### Choice of Cell Volumes:

The Affinity ITC features two fixed-in-place calorimetric cells: a sample cell where injections take place and a matching reference cell. Two cell volumes are available: 1.0 mL (Standard Volume) and 190  $\mu$ L (Low Volume). Automation is available in either configuration.

Selection of cell volume depends on the range of binding constants to be measured ( $K_d$ : mM to low nM) and the availability of sample. TA Instruments' experienced application teams can recommend the best instrument configuration for your specific measurement requirements.

### Cylindrical Cell Geometry:

The cylindrical cell geometry maximizes stirring efficiency, eliminates dead zones and entrapped air bubbles which are common in competitive designs.

### Cell Composition:

To maximize measurement accuracy and response, the Affinity ITC Standard Volume configuration has cells constructed of either 24 k 99.999% Gold (Au0) or Hastelloy. The Low volume configuration is only available with the Gold (Au0) cells. The inert chemical properties of Gold, its high thermal conductivity and its ability to be cleaned with strong acids and bases make it the preferred choice for ultrasensitive ITC instruments.



Low Volume  
(190  $\mu$ L)

Standard Volume  
(1.0mL)

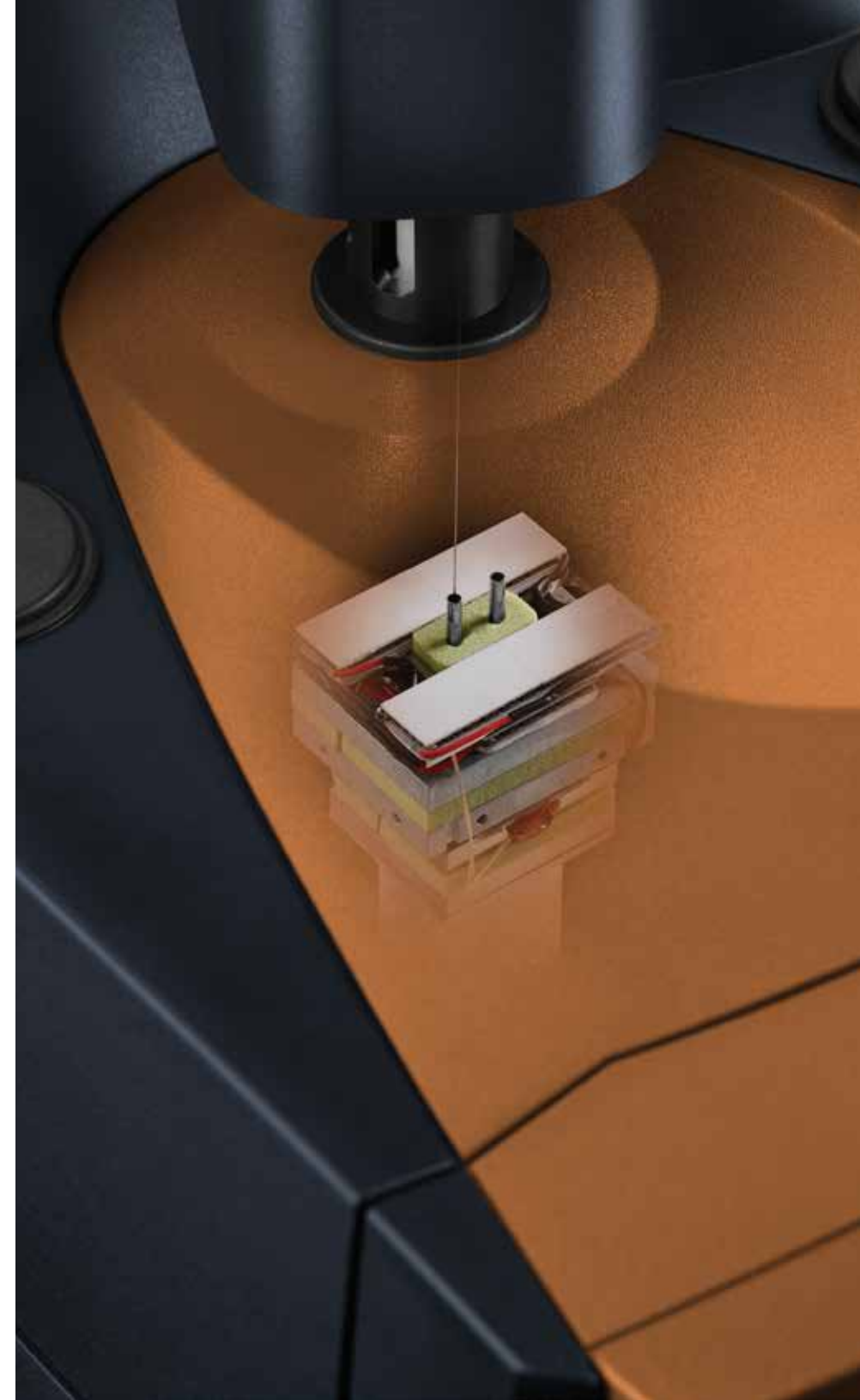

**Solid-State Temperature Control & Power Compensation Operation. The Affinity ITC utilizes multiple solid-state thermoelectric elements for active heating and cooling of the sample and reference cells.**

### Advantages of active heating and cooling:

- Faster heating and cooling between temperature set points
- Rapid equilibration at temperature set point
- Active temperature control eliminates drift on long ITC experiments

The absorption or evolution of heat as a result of a binding reaction is detected by the thermoelectric elements after which heater power is adjusted to maintain the temperature difference between the sample and reference cell at zero. The combination of power compensation and thermoelectric temperature control ensures the fastest response and highest resolution for ITC.

## FlexSpin™

New FlexSpin technology dramatically improves one of the most important aspects of ITC experiments, mixing.

### Features and Benefits:

- Revolutionary new paddle shape and its separation from injection system results in better mixing, sharper peaks and faster return to baseline
- More efficient mixing and precise delivery of titrant reduces peak width up to 50%
- Improved sample delivery system decreases equilibration times by 40%
- Slower stir speeds (10X slower than competitive instruments) for highest sensitivity while protecting delicate structures
- In conjunction with cylindrical cell shape, eliminates dead zones
- Suspended on a flexible support, eliminating the possibility of damage due to misalignment



## AccuShot™

The precision and the location of the titrant delivery are critical to obtaining the highest quality ITC data. The AccuShot injection system has been completely redesigned to optimize these factors. AccuShot delivers the right amount of titrant in the right location, every time.

### Features and Benefits:

- Injection system separate from stirring mechanism
- Syringe needle positioned to deliver titrant at the top of stirring paddle for better mixing and sharper peaks
- High precision stepper motor for the most accurate delivery of a 0.01  $\mu\text{L}$  to 250  $\mu\text{L}$  injection
- Improved sample delivery system decreases equilibration times by 40%
- Small diameter cannula minimizes 1st injection diffusion
- Single syringe for all injection volumes and experiment designs
- Quick, easy syringe replacement
- Easy titrant loading without injection syringe removal
- Fully automated internal and external cleaning of injection cannula

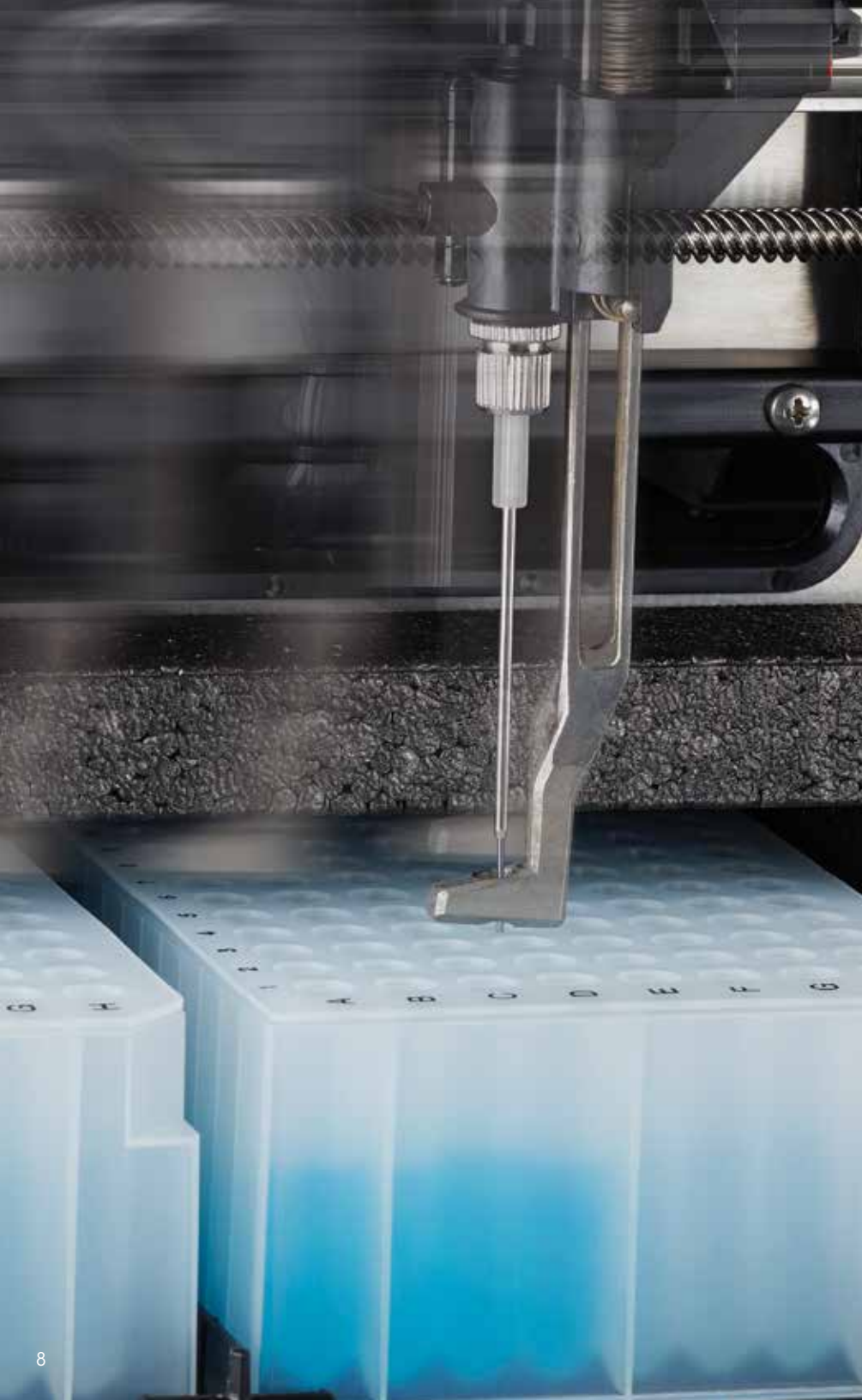

## AFFINITY ITC AUTO | TECHNOLOGY

What others have attempted TA Instruments has perfected. By combining automation and liquid handling technology prevalent in today's life science laboratories with the high performance Affinity ITC, TA has created the most powerful platform for automated, high throughput ITC experiments.

### Affinity ITC Autosampler Features and Benefits:

- HPLC grade liquid handling
- Small benchtop footprint to optimize space
- Samples configured in two (2) 96-well plates
- User-selectable temperature control (ambient down to 4°C)
- Full sample pathway cleaning capability
- Batch file processing for rapid analysis and reporting
- Sample throughput: From 10 to 50 per day depending on experimental conditions
- Optimization tool in NanoAnalyze guides users to proper experimental parameters and maximizes throughput



# AFFINITY ITC AUTO | INTELLIGENT HARDWARE POSITIONING

Previous attempts at ITC automation commonly experience misalignment, broken and bent syringes and overall reliability issues. Intelligent Hardware Positioning eliminates these issues and ensures accurate and reliable placement of automated hardware on the Affinity ITC.

## Features and Benefits:

- Alignment tabs ensure perfect positioning of the cell loading needle, stirring mechanism, and titrant injection cannula into the sample cell
- Self-aligning arms are part of a proprietary design that provides safe, error-free positioning

The Intelligent Hardware Positioning gives users a new level of confidence for safe, reliable, unattended, continuous operation of the Affinity ITC.



The automated cleaning system engineered into the Affinity ITC Auto instrument ensures that the entire system is cleaned between sample titrations. This completely eliminates cross-contamination from one run to another.

## Cleaning Features and Benefits:

- Dedicated wash/rinse stations for stirring/injection syringes and cell cleaning/filling
- User-programmable cleaning routines can be saved and retrieved
- Fully automated cleaning of the internal and external surfaces of key components, including autosampler transfer syringe and needle
- Five user-selectable cleaning solutions
- Complete sample pathway cleaning

|                                    | Affinity ITC Auto | Affinity ITC    |
|------------------------------------|-------------------|-----------------|
| <b>Injection/Stirring cleaning</b> | Fully automated   | Fully automated |
| <b>Cell cleaning</b>               | Fully automated   | Cleaning tool   |
| <b>Cell filling cleaning</b>       | Fully automated   | Manual          |



Dedicated Wash Station



Autosampler Stream Selection Valve

### Affinity ITC Auto Reproducibility

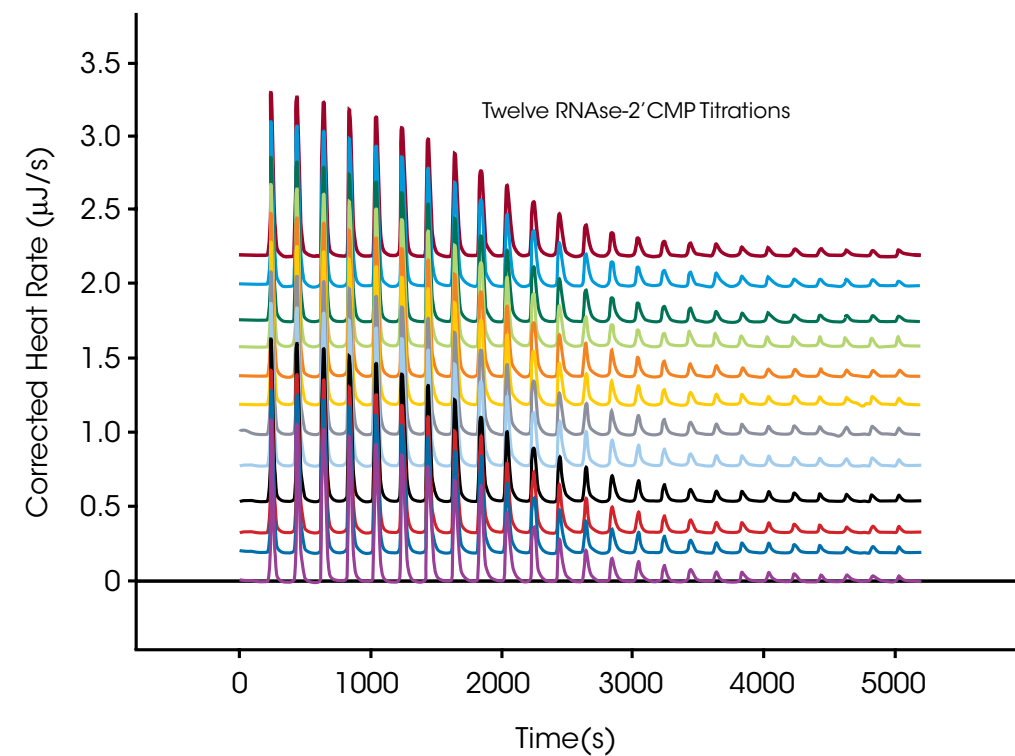

The Affinity ITC Auto provides unmatched sample reproducibility with the highest sensitivity and reliability. The figure shows twelve titrations performed with complete system cleaning performed between each titration. Data plots are offset for display purposes.

### Affinity ITC Auto Cleaning Efficiency

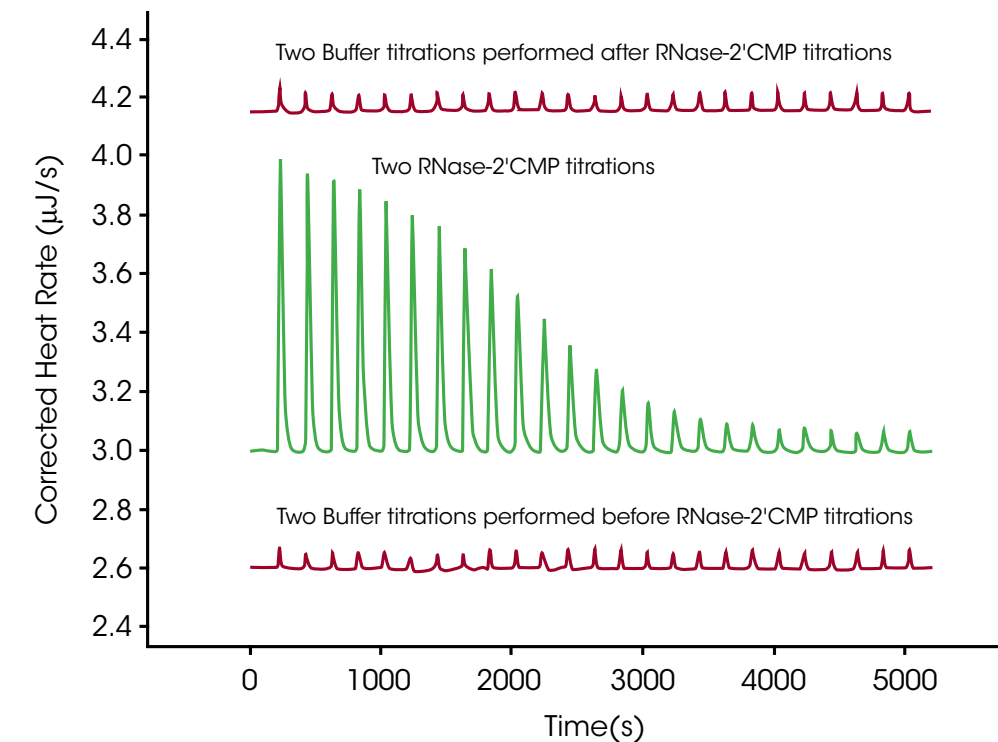

Complete system cleaning is user-programmable with Affinity ITC Auto instrument control software. Choosing from five (5) solvent ports ensures the entire sample path is clean. The buffer titrations before and after the protein-ligand titrations provide the highest confidence in the cleaning protocol for the Affinity ITC Auto.





The NANO ITC features many of the high performance technologies found in the Affinity ITC. It is a versatile, high-sensitivity, cost-effective isothermal titration calorimeter that can easily outperform competitive systems in a wide range of applications.

#### Features and Benefits:

- Choice of Standard Volume (1.0 mL) or Low Volume (190  $\mu$ L) cells
- Solid-state active heating and cooling for true isothermal temperature control
- High precision injection buret for accurate titrant delivery
- Unique removable injection syringe for fast, reliable loading and cleaning
- Powerful ITCRun and NanoAnalyze for the most comprehensive suite of tools for method optimization, model fitting, batch analysis, graphing and data export



## NANO ITC | TECHNOLOGY

The Nano ITC cell is optimized in shape, material, and volume to provide the greatest measurement accuracy over the widest range of sample chemistries.

### Choice of Cell Volumes:

The Nano ITC features two fixed-in-place calorimetric cells: a sample cell where injections take place and a matching reference cell. Two cell volumes are available: 1.0 mL (Standard Volume) and 190  $\mu$ L (Low Volume).

Selection of cell volume depends on the range of binding constants to be measured ( $K_d$ ; mM to low nM) and the availability of sample. TA Instruments' experienced application teams can recommend the best instrument configuration for your specific measurement requirements.

### Cylindrical Cell Geometry:

The cylindrical cell geometry maximizes stirring efficiency, eliminates dead zones and entrapped air bubbles, which are common in competitive designs.

### Cell Composition:

To maximize measurement accuracy and response, the Nano ITC Standard Volume configuration has cells constructed of either 24 k 99.999% Gold (Au0) or Hastelloy. The Low volume configuration is only available with the Gold (Au0) cells. The inert chemical properties of Gold, its high thermal conductivity and its ability to be cleaned with strong acids and bases make it the preferred choice for ultrasensitive ITC instruments.



Low Volume  
(190  $\mu$ L)

Standard Volume  
(1.0mL)

The Nano ITC utilizes multiple solid-state thermoelectric elements for active heating and cooling of the sample and reference cells. A unique removable buret and injection syringe ensures easy sample loading and accurate sample delivery.

### Accurate Temperature Control with Active Heating and Cooling:

- Faster heating and cooling between temperature set points
- Rapid equilibration at temperature set point
- Active temperature control eliminates drift on long ITC experiments

The absorption or evolution of heat as a result of a binding reaction is detected by the thermoelectric elements after which heater power is adjusted to maintain the temperature difference between the sample and reference cell at zero. The combination of power compensation and thermoelectric temperature control ensures the fastest response and highest resolution for ITC.

### Unique Injection Buret and Removable Injection Syringe:

- Accurate control of the titrant volume delivery and user-selectable stir speed is accomplished with a unique, easily removed buret
- Removable injection syringes allows thorough cleaning and easy sample loading.
- Partial syringe fills for short titrations are user-programmable in the instrument control software

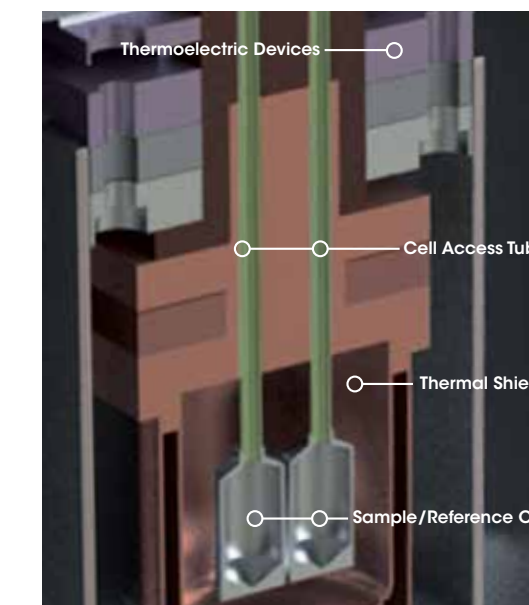

# THE POWER OF ITC | THEORY

## ITC Theory

All molecular interactions have a unique thermodynamic signature that is characterized by

- Binding constant ( $K_D$ )
- Enthalpy ( $\Delta H$ )
- Entropy ( $\Delta S$ )
- Stoichiometry (n)

ITC is a label-free direct measurement of the heat evolved or absorbed during a binding reaction.

The data from a typical binding experiment is shown to the right. The integrated areas under each injection peak are plotted against the molar ratio of the active species. An independent binding model is fit to this data to directly determine the enthalpy ( $\Delta H$ ), binding constant ( $K_D$ ) and stoichiometry (n).  $K_D$  represents the association binding constant. The dissociation binding constant,  $K_D'$ , is defined as  $1/K_D$ .

Gibbs Free Energy is calculated directly from the binding constant,  $K_D$   
 $\Delta G^\circ = -RT \ln K_D$

The change in entropy ( $\Delta S$ ) term is then calculated directly  
 $\Delta G^\circ = \Delta H - T\Delta S$

ITC is a powerful analytical technique that does not require labeling or immobilization and is considered the most sensitive, accurate assay method for optimizing laboratory productivity in life science applications, such as drug discovery and validation, molecular variant comparisons and protein-protein interactions.

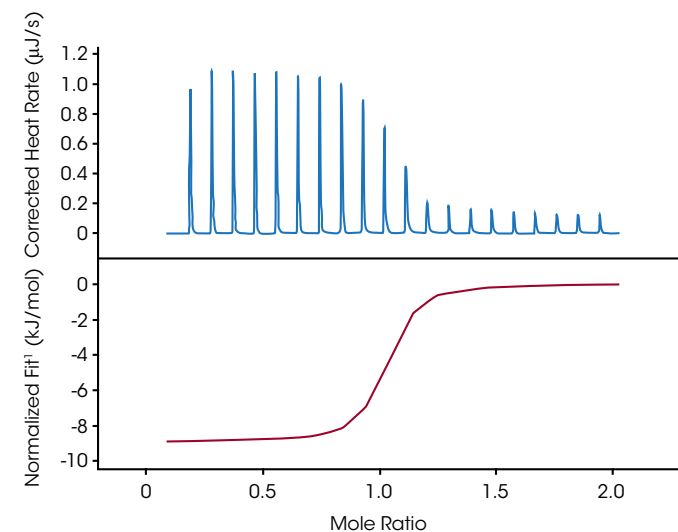

| Thermodynamics Reveals Nature of Binding |  |
|--|--|
| $\Delta G^\circ$                         | Total Binding Affinity                                 |
| $\Delta H$                               | Hydrogen-bond formation and van der Waals interactions |
| $\Delta S$                               | Desolvation and Conformational effects                 |

## Enzyme Kinetics Using ITC

In addition to binding, an isothermal titration calorimeter is also a powerful tool to perform enzyme kinetics analysis. The substrate concentration-dependent heat flow of enzymatic reactions may be used for kinetics analysis and the determination of Michaelis-Menten reaction parameters:

### Features and Benefits:

- No labeling, immobilization or modification required
- No limit on solution turbidity
- Ideal for characterization of novel enzyme-substrate reactions
- Continuous assay, no need to quench the reaction

The rate of heat flow and reaction enthalpy are easily and accurately determined using the multiple injection method (top figure). Michaelis-Menten and Lineweaver-Burk plots (bottom figure) are used to fit the data from the top figure to determine reaction kinetics parameters.

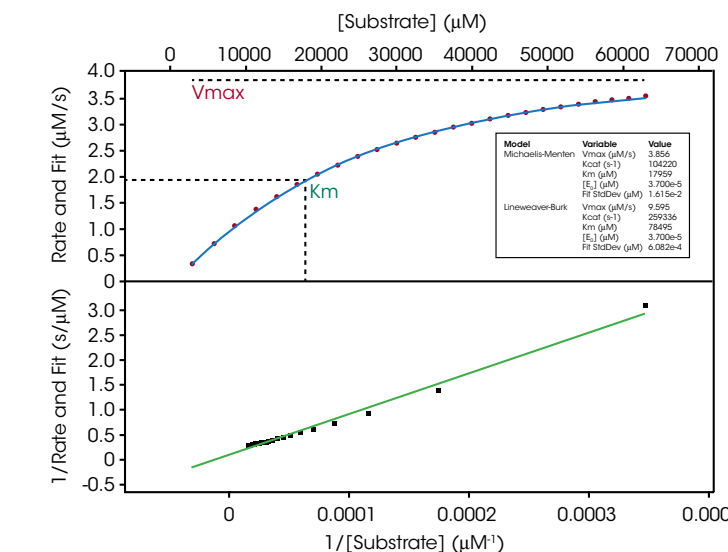
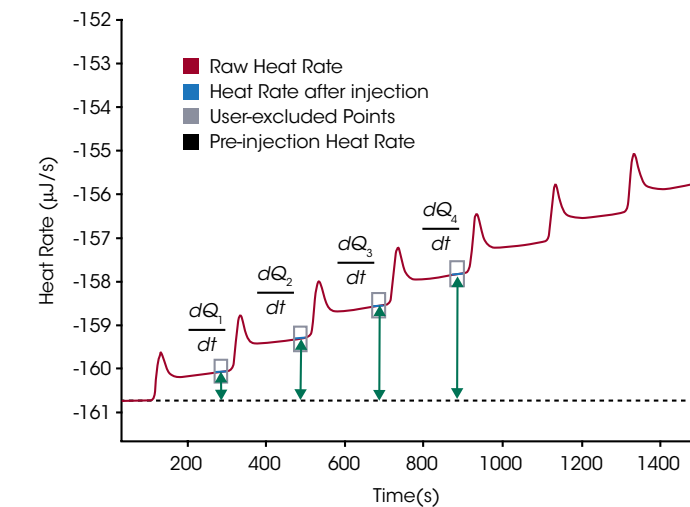

### Low and Standard Volume Comparison

The sensitivity of the Nano ITC Low Volume ensures that with less sample the instrument will generate accurate and reproducible results in a shorter overall titration time. The Standard Volume and Low Volume Nano ITC instruments provide the flexibility and sensitivity for performing a wide variety of ITC experiments.

#### Nano ITC Low Volume:

- Sample Cell =  $\text{KHCO}_3$ ; 0.36 mM
- Injection Syringe = HCl; 4.2 mM
- Injection volume = 1.4  $\mu\text{L}$
- Injection interval = 175 sec
- provides the highest sensitivity
- can produce shortest titration times
- is ideal for maximizing the data with minimum sample consumption

#### Nano ITC Standard Volume:

- Sample Cell =  $\text{KHCO}_3$ ; 0.36 mM
- Injection Syringe = HCl; 5.6 mM
- Injection volume = 5  $\mu\text{L}$
- Injection interval = 300 sec
- Allows more sample mass to be loaded
- Produces high quality data when the molecular interactions are high affinity and yield low heat values

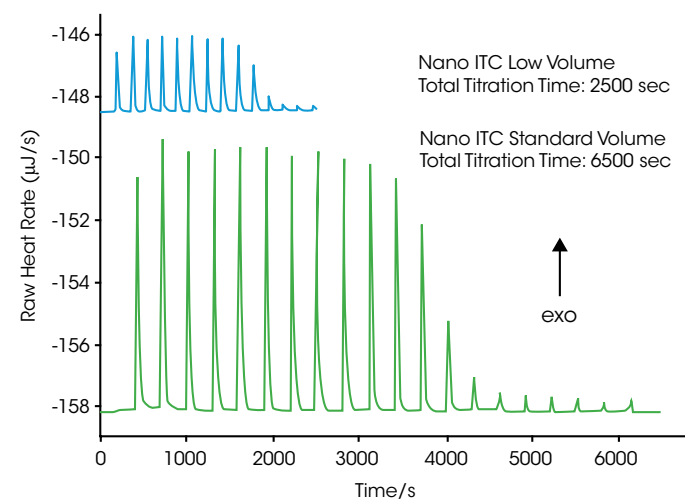

### Characterizing Binding Interactions by ITC

All binding events are accompanied by the evolution or absorption of heat (a change in enthalpy,  $\Delta H$ ). In a single ITC experiment a full thermodynamic characterization of the binding reactions can be obtained. With the appropriate experimental design, fundamental information about the molecular interactions driving the process, as well as the stoichiometry of binding ( $n$ ) and the binding constant ( $K_d$ ) is generated. The first figure shows a typical incremental titration (20, 5  $\mu\text{L}$  injections) of an inhibitor, 2'-CMP, titrated into RNase A;  $n = 0.99$ ,  $K_d = 5.92 \times 10^{-7} \text{ M}$ , and  $\Delta H = -64.4 \text{ kJ mol}^{-1}$ . The second figure shows the same experiment, plotting the individual integrated peak areas vs the ratio of the two binding molecules. As the binding sites become saturated, the amount of heat produced with individual injections decreases. The resulting titration curve reveals valuable information on the enthalpy ( $\Delta H$ ), entropy ( $\Delta S$ ) and overall Gibbs free energy ( $\Delta G^\circ$ ) of the reaction taking place in the calorimeter. ITC is a powerful analytical tool and considered the most sensitive assay technique for characterizing the fundamental driving forces of molecular binding reactions.

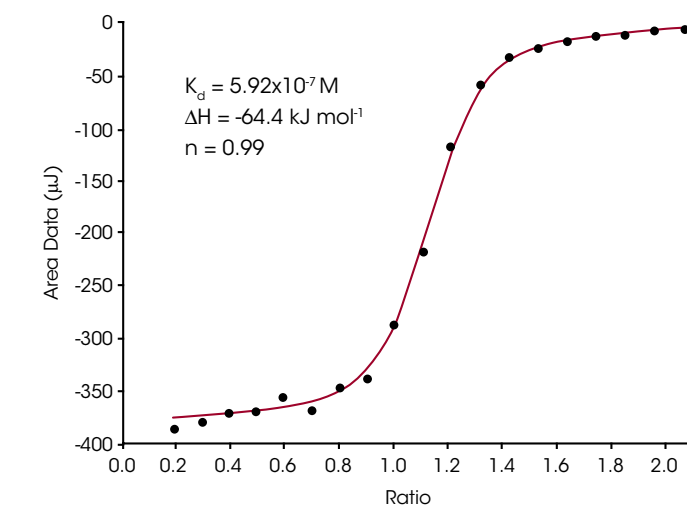
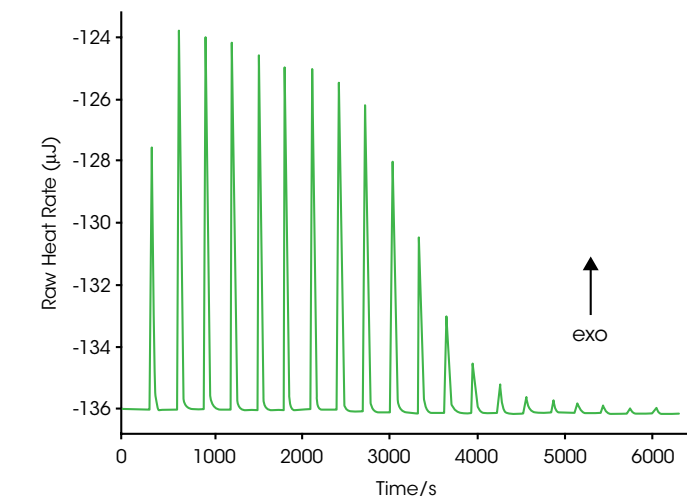

### Protein Interactions

When two proteins interact and bind, conformational changes in the proteins, and rearrangement of the solvent in the vicinity of the binding site, result in the absorption or generation of heat. Quantification of this reaction heat by ITC provides a complete thermodynamic description of the binding interaction, the stoichiometry of binding, and the association constant. This figure contains the titration data of porcine pancreatic trypsin into soybean trypsin inhibitor using a Nano ITC. Twenty, 5  $\mu\text{L}$  aliquots of ligand were titrated into the sample cell while the temperature of the system was maintained at 25  $^{\circ}\text{C}$ . Top panel: The signal (heat) produced following each addition of protein to the inhibitor. Bottom panel: Integration of the heats over the time course of the experiment; the  $\mu\text{J}$  in each peak are plotted against the mole ratio of the titrant to inhibitor.

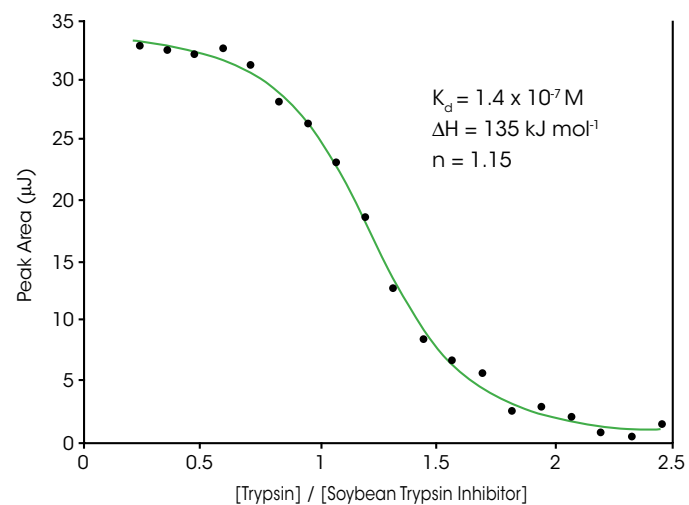
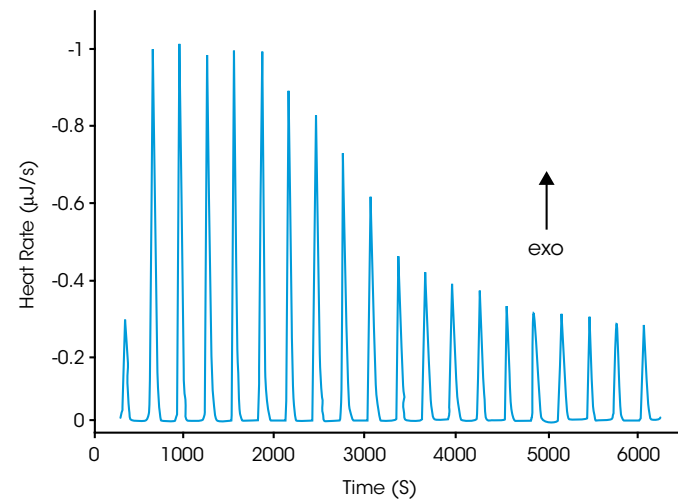

### Characterization of Enzyme Kinetics

Every reaction generates or absorbs heat, so every reaction can in principle be studied by calorimetry. In practice it has been shown that representative enzymes from every EC classification can be analyzed kinetically using ITC. In addition, ITC analyses are rapid, precise, nondestructive, compatible with both physiological and synthetic substrates, and are as sensitive as spectroscopic techniques but do not require a spectroscopic label or chemical tag. Importantly, ITC analyses of enzyme kinetics are also straightforward. The figure shows the hydrolysis of a single 10  $\mu\text{L}$  injection of trypsin into a solution of BAEE in the absence (blue) and presence (red) of benzamidine, a competitive inhibitor. The area under both curves (representing the total heat output for complete conversion of substrate to product) is the same either in the presence or absence of inhibitor, allowing the  $K_M$  and  $k_{cat}$  of the reaction under both conditions to be calculated, as well as the inhibition constant.

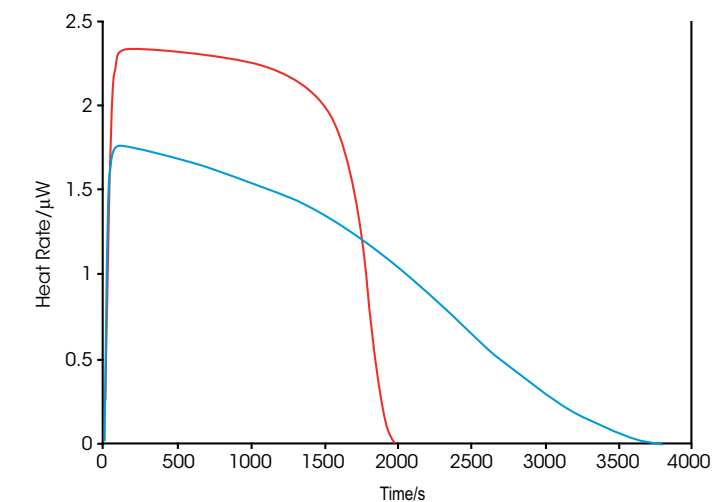

### Continuous Single Injection

Continuous single injection titration is an attractive alternative to the traditional incremental titration ITC for samples exhibiting very rapid binding reactions. These continuous injection experiments can be completed in less total time than normally required for a full set of incremental titrations. This technique provides accurate determinations of stoichiometry ( $n$ ) and enthalpy ( $\Delta H$ ) for a wide range of binding constants. Continuous injection and incremental injection experiments can be performed in both the ITC standard volume and low volume instruments with no alterations in hardware or software supplied with the instruments.

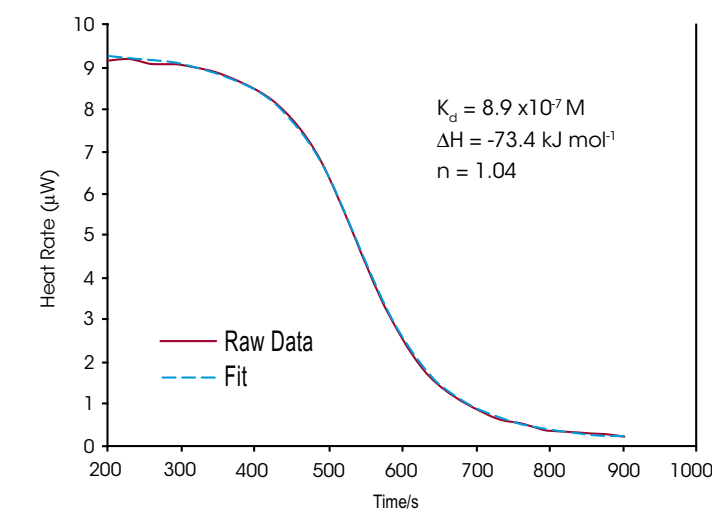



## NANO DSC AND DSC AUTO | DIFFERENTIAL SCANNING CALORIMETER

The Nano DSC has the versatility and precision for characterizing molecular stability, determining high affinity ligand binding and deconvoluting multi-domain structures. There is no other DSC with the proprietary technologies, high performance or the sample throughput of the Nano DSC and Nano DSC Auto.

### Features and Benefits:

- Highest sensitivity, lowest cell volume for unmatched performance
- Capillary cell design for analysis of samples that tend to aggregate or precipitate
- Built-in precision pressurizing system maintains accurate, constant pressure in the cells
- Solid-state thermoelectric elements for accurate temperature control during heating and cooling scans
- Upgradeable with industry proven HPLC grade autosampler for reliable high sample throughput



## NANO DSC | TECHNOLOGY

The Nano DSC is designed for ultra-sensitive measure of heat absorbed or released by dilute in-solution bio-molecules as they are heated or cooled. The capillary cell design, solid-state thermoelectric temperature control and easy cleaning ensure the highest sensitivity and data reproducibility for a wide variety of applications.

### Features and Benefits:

- 300  $\mu$ L active volume capillary cells for analyzing hydrophobic samples
- Easy, accurate sample loading with laboratory pipette
- Built-in, user-programmable pressurization system (up to 6 atm)
- Flexible data acquisition interface for easy experiment setup
- NanoAnalyze software for accurate model fitting and multi-file batch processing



The NanoDSC is a powerful thermal scanning instrument that utilizes a 300  $\mu$ L capillary cell design and solid-state thermoelectric temperature control to provide unmatched performance.

### Nano DSC Capillary Platinum Cells

- Fixed-in-place capillary cells attenuate aggregation and precipitation
- Platinum cells are inert and compatible with strong acids, bases and protein cleaning enzymes
- 300  $\mu$ L active cell volume minimizes sample consumption
- Sample cell loading with laboratory pipette is easy and ensures no trapped air bubbles

### Nano DSC Solid-State Thermoelectric Temperature Control:

- Accurate, reproducible temperature control for highest sensitivity in both heating and cooling scans and unmatched baseline reproducibility
- Innovative, user-programmable built-in pressure system for complex analysis of water characteristics and molecule structure
- User-programmable scan rates for scan flexibility and highest confidence in data analysis

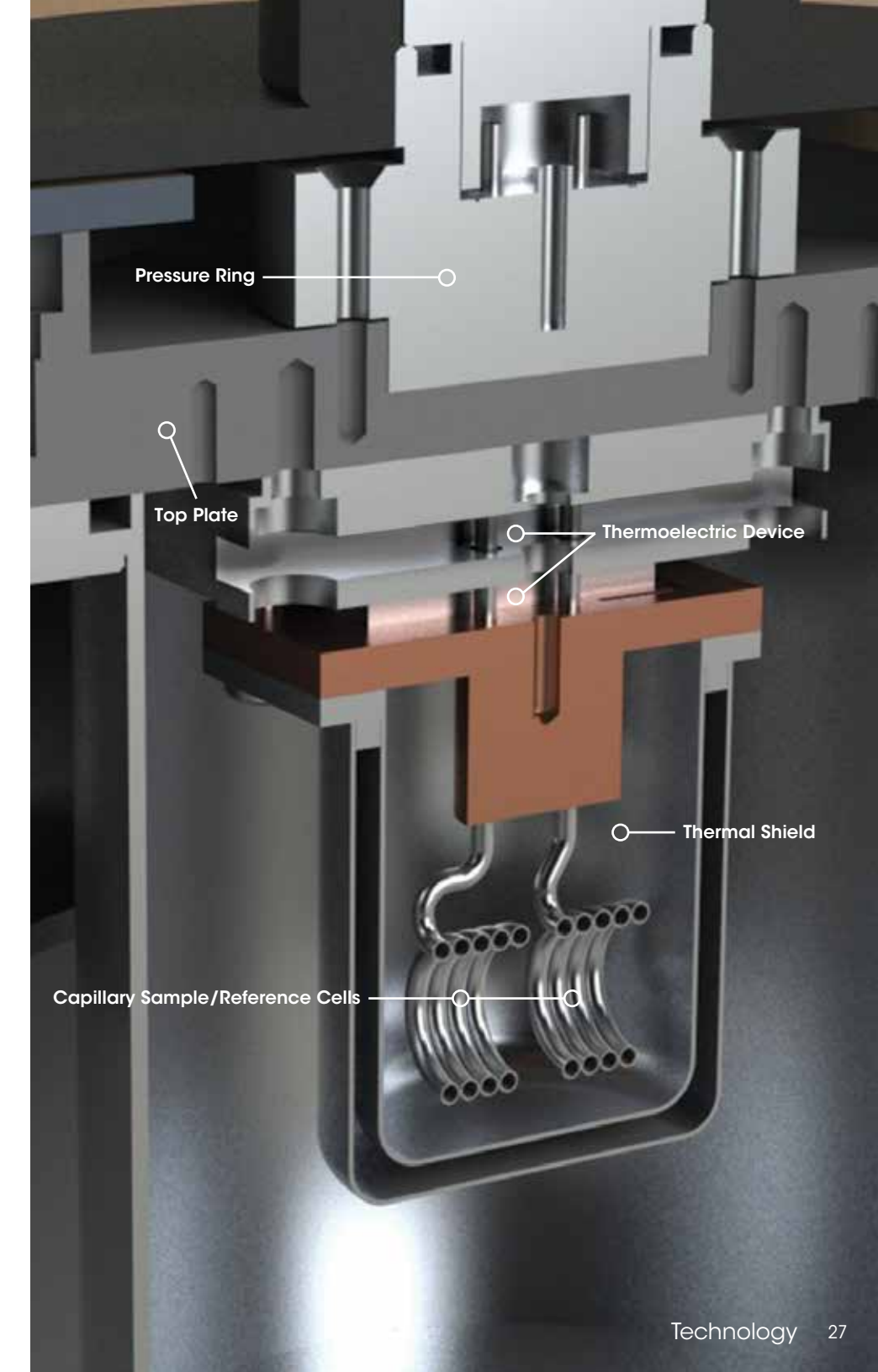

The Nano DSC Autosampler enables true “start and walk away” capability without sacrificing either sensitivity or reliability. It is an industry-proven 96-well plate autosampler that stores and delivers samples to the DSC cells. User-programmable washing routines ensure no sample carry over and the 96-well format maximizes sample throughput.

### Autosampler Features and Benefits:

- Industry-proven HPLC autosampler reliability
- Easy connection to the Nano DSC through autosampler interface
- Two (2) 96-well plates store samples at temperatures down to 4°C
- Four (4) wash/rinse solvent ports on the autosampler interface are user-programmable
- Two (2) exit ports enable the collection of sample and matching buffer/solvent solutions from both the sample or reference cells
- Autosampler is programmable through the Nano DSC instrument operating software



### How much Protein is Required for a DSC Scan?

Determining the thermodynamic parameters of a protein by differential scanning calorimetry (DSC) using the Nano DSC requires about the same amount of protein as surface plasmon resonance or fluorescence studies. Because of the Nano DSC’s extreme sensitivity and baseline reproducibility, and the sample cell’s small volume (300  $\mu$ L), a complete, interpretable, accurate scan can be obtained on essentially any protein of interest. The sensitivity and accuracy of the Nano DSC is demonstrated by this data. Hen egg white lysozyme (in pH 4.0 glycine buffer) was prepared at various concentrations. As little as 2  $\mu$ g of lysozyme in the capillary cell is sufficient to provide quality data yielding accurate values of all four thermodynamic parameters!

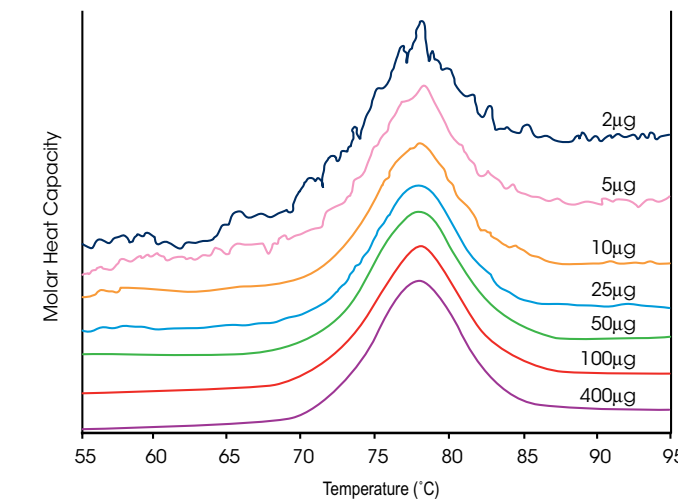

| Lysozyme in cell ( $\mu$ g) | Calorimetric                        |   | Van't Hoff                   |                                     |
|-----------------------------|-------------------------------------|---|------------------------------|-------------------------------------|
|                             | $\Delta H$ ( $\text{kJ mol}^{-1}$ ) | $\Delta S$ ( $\text{kJ K}^{-1} \text{mol}^{-1}$ ) | $T_m$ ( $^{\circ}\text{C}$ ) | $\Delta H$ ( $\text{kJ mol}^{-1}$ ) |
| 400                         | 512                                 | 1.46  | 78.0                         | 515                                 |
| 100                         | 512                                 | 1.46  | 78.0                         | 509                                 |
| 50                          | 517                                 | 1.47  | 77.9                         | 513                                 |
| 25                          | 513                                 | 1.46  | 77.8                         | 513                                 |
| 10                          | 515                                 | 1.47  | 78.0                         | 515                                 |
| 5                           | 490                                 | 1.40  | 78.0                         | 510                                 |
| 2                           | 503                                 | 1.43  | 77.8                         | 499                                 |



## Characterization of Protein Stability

Analyzing the stability of a protein in dilute solution involves determining changes in the partial molar heat capacity of the protein at constant pressure ( $\Delta C_p$ ). The contribution of the protein to the calorimetrically measured heat capacity (its partial  $C_p$ ) is determined by subtracting a scan of a buffer blank from the sample data prior to analysis. Heating the protein sample initially produces a slightly increasing baseline but as heating progresses, heat is absorbed by the protein and causes it to thermally unfold over a temperature range characteristic for that protein, giving rise to an endothermic peak. Once unfolding is complete, heat absorption decreases and a new baseline is established. After blank subtraction, the data can be analyzed to provide a complete thermodynamic characterization of the unfolding process.

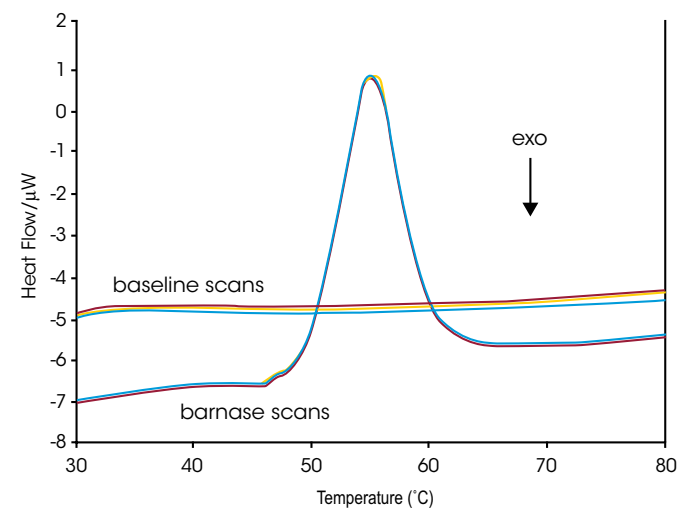

## Characterization of Protein Structure

DSC can be used to characterize both the specific binding of a ligand (for example, a drug to a receptor binding site), or nonspecific binding (for example, detergents binding to hydrophobic patches on a protein surface). In some instances ligand binding, even if to a specific receptor site, results in long-range protein structural rearrangements that destabilize the entire complex. The figure shows DSC scans of  $Ca^{2+}$  saturated bovine  $\alpha$ -lactalbumin at various protein:  $Zn^{2+}$  ratios scanned at  $1^{\circ}C/min$ . The midpoint of the thermal unfolding of the protein decreases from  $65^{\circ}C$  in the absence of  $Zn^{2+}$  to  $35^{\circ}C$  at a protein:  $Zn^{2+}$  ratio of 1:70. The enthalpy of unfolding is also decreased substantially by high  $Zn^{2+}$  concentrations.

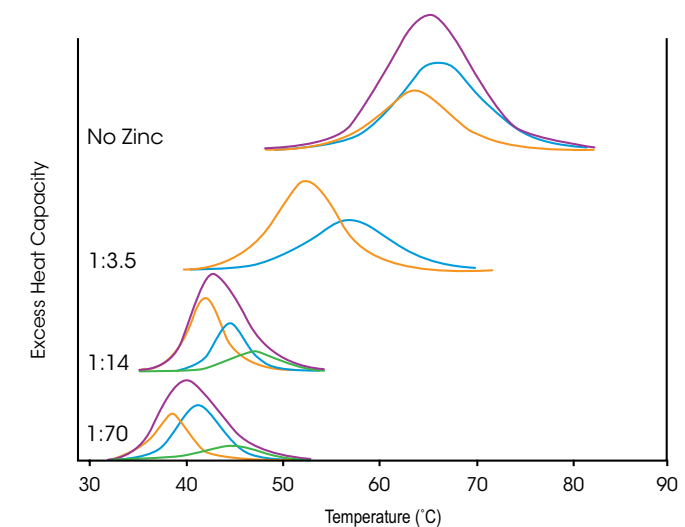

## Investigation of Protein-Ligand Binding

DSC is a valuable tool for studying binding between a biological macromolecule and a ligand such as another biopolymer or a drug. Unlike ITC, DSC allows the thermodynamics that drive binding to be correlated with conformational changes in the macromolecule caused by the binding reaction. DSC is particularly useful for characterizing very tight or slow binding interactions. DSC also allows characterization of binding reactions that are incompatible with the organic solvent requirements of some ITC experiments (i.e., where ligand solubility for an ITC experiment requires concentrations of organic solvent not tolerated by the protein). The data shows DSC scans of RNase A bound with increasing concentrations of 2'-CMP showing that the protein is stabilized by higher concentrations of the inhibitor. Essentially identical data was obtained in the presence of 5% DMSO, verifying that organic solvents are compatible with the DSC technique.

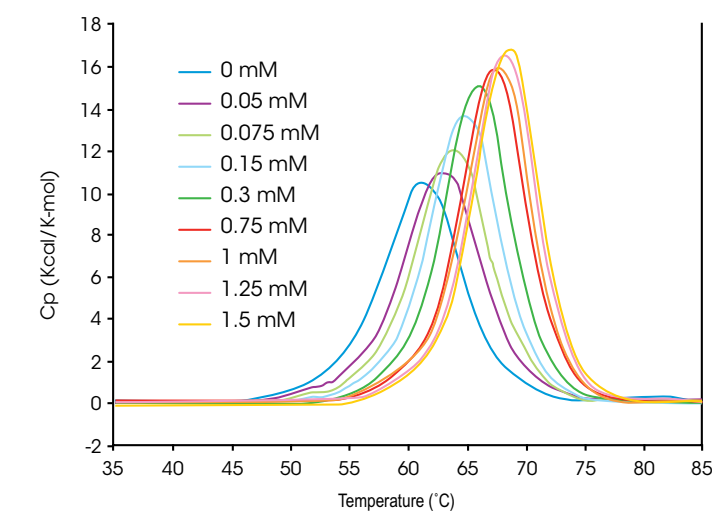

## Nano DSC Capillary Cell Advantages

This figure shows two DSC scans of matched samples of human IgG1 at 0.5 mg/ml in physiological buffer. The data from the DSC with a "coin" shaped sample cell shows the easily recognizable exothermic aggregation/precipitation event at approx  $89-90^{\circ}C$ , while the data collected on the Nano DSC with a capillary sample cell shows a stable post-transition baseline that will enable complete and accurate determinations of transition temperatures ( $T_m$ ) and enthalpy ( $\Delta H$ ).

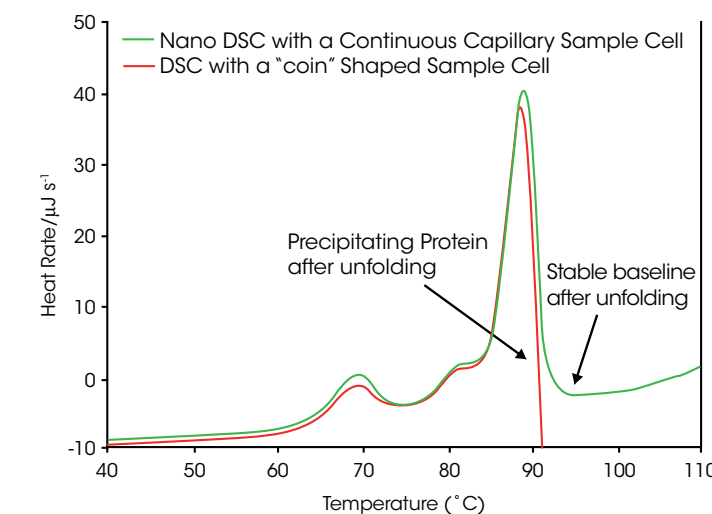

## Instrument Control & Data Acquisition Software

The Affinity and Nano instruments control and data acquisition functions are executed within a Windows-compatible software interface, ITCRun or DSCRun. All experimental parameters and sample information are easily entered into an intuitive graphical user interface and can be saved as an experimental template for future use.

Real-time monitoring of the raw data as the experiment progresses allows rapid assessment of the data quality and instrument performance in individual tabs. Unique icon-controlled functions, such as immediate baseline subtraction, are always available on the display.

## ITCRun & DSCRun Features and Benefits:

- Automatic configuration of user interface for automated or non-automated instruments
- Individual viewing tabs for real-time monitoring of instrument performance characteristics and raw data acquisition
- Easy experiment setup
- Direct autosampler programming and control for automated instruments
- Software passes all experimental parameters to NanoAnalyze™



## Data Analysis with NanoAnalyze™

All ITC and DSC raw data files are easily and quickly analyzed with a powerful ITC/DSC data analysis software, NanoAnalyze. Individual window tabs for each processing step guide the user through the analysis of Individual raw data files or the batch processing of multiple files.

## NanoAnalyze™ Features and Benefits:

- Easy import of all ITC and DSC raw data files
- User-selectable fitting models for ITC and DSC
- Easy set up of new fitting models
- Drag & Drop subtraction of baseline blank files
- Powerful experiment design and optimization tool
- Flexible overlay graphs for quick data comparisons
- Generates thermodynamic profile bar graph
- Easy export of all data to delimited text files
- Full-featured editing tools for preparation of publication quality images

All instrument control, data acquisition and data analysis software required for ITC and DSC data are provided with all Affinity and Nano instruments. All software updates and feature improvements are available on the TA Instruments website.

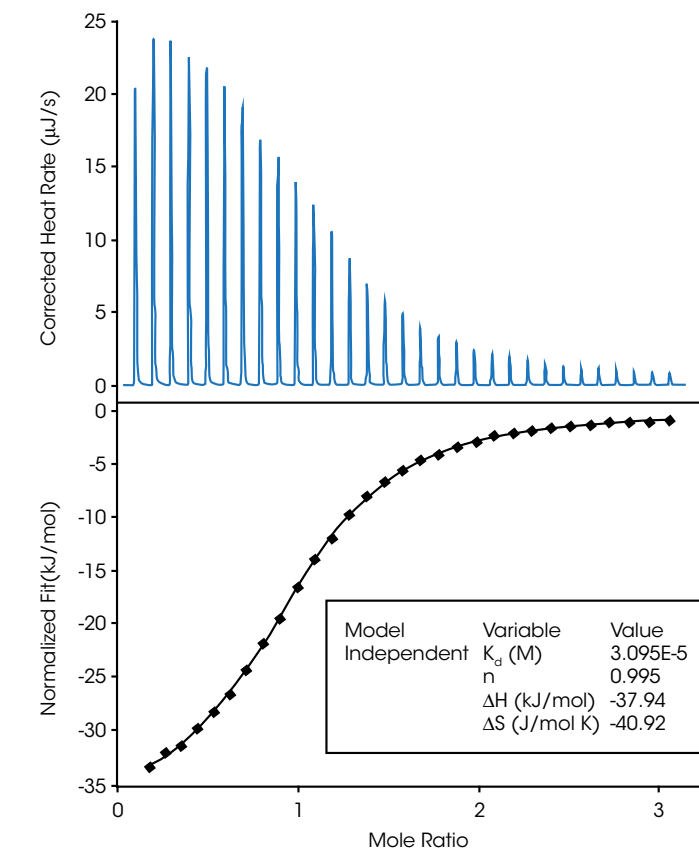

### Automated Cleaning Station

The Cleaning Station provides user-programmable, automated cleaning of sample cells in the Nano ITC, Affinity ITC and Nano DSC. It is a stand-alone easy-to-use cell cleaning accessory that is touch-screen operated and can be connected to a computer via USB for downloading custom cleaning methods created on a dedicated software program. The Cleaning Station is a convenient, reliable microcalorimetry accessory for automated sample cell cleaning in TA Instruments' ultrasensitive ITC and DSC instruments.



### Cleaning Station Features and Benefits:

- Cleaning accessory for all Nano ITC, Affinity ITC and Nano DSC instruments
- Compatible with all Nano ITC and Affinity ITC cell cleaning tools
- Stand-alone accessory with easy-to-use touch-screen operation
- 3 solvent inlets for programming simple rinses or complex cleaning methods
- USB connection to computer for downloading custom cleaning methods
- Dedicated Cleaning Station Method Editor software



### Degassing Station

The Degassing Station is a stand-alone, touch-screen operated multi-featured microcalorimetry accessory for reliable sample preparation and manual cell cleaning method execution for all Nano ITC, Affinity ITC and Nano DSC instruments. The degassing chamber will accommodate a variety of sample tubes and vials as well as a standard 96-well plate and serve as a stirring platform for effectively degassing samples prior to an ITC or DSC analysis. The vacuum source connections are compatible with all Nano ITC and Affinity ITC cleaning tools. The Degassing Station is a reliable, easy-to-use accessory for maintaining sample integrity and cell cleanliness in TA Instruments' ultra-sensitive ITC and DSC Instruments.

### Features and Benefits:

- Stand-alone accessory with easy-to-use touch-screen operation
- Sample Equilibration Temperature Range (0 °C to 80 °C)
- Temperature adjustment rate of 2.5 C/min for quick, accurate changes
- Vacuum Control Range (1-25 "Hg) for effective sample degassing and cell cleaning
- Vacuum chamber for degassing sample in vials/tubes or a single 96-well plate
- Stirring rates (120 - 1500 rpm) for effective stirring of large or small sample volumes
- Timer Range (0-99 min)



| Affinity ITC and ITC Auto                  | Standard Volume           | Low Volume                |
|--|---------------------------|---------------------------|
| Minimum Detectable Heat                    | 0.1 µJ                    | 0.04 µJ / 0.05 µJ         |
| Maximum Measurable Heat                    | 5,000 µJ                  | 5,000 µJ                  |
| Low Noise Level                            | 0.0025 µWatt              | 0.0013 µW / 0.0014 µWatt  |
| Baseline Stability                         | 0.02 µWatt/hr             | 0.02 µWatt/hr             |
| Temperature Stability                      | ± 50 µ°C at 25°C          | ± 8 µ°C / 50 µ°C at 25°C  |
| Temperature Control                        | Active heating & cooling  | Active heating & cooling  |
| Operating Temperature                      | 2 to 80°C                 | 2 to 80°C                 |
| Sample Cell Size                           | 1.0 mL                    | 190 µL                    |
| Injection Syringe Volume                   | up to 250 µL              | up to 250 µL              |
| Minimum Injection Volume                   | 0.01 µL                   | 0.01 µL                   |
| Stirring Speed Range                       | 0 – 200 rpm               | 0 – 200 rpm               |
| Response Time                              | 13 Sec / 18 Sec           | 3.3 sec / 11 Sec          |
| Cell Geometry                              | Fixed Cylindrical         | Fixed Cylindrical         |
| Cell Composition                           | 24K Gold / Hastelloy      | 24K Gold / Hastelloy      |
| <b>Automation Specifications</b>           |                           |                           |
| Autosampler Tray Temperature Control Range | Ambient to 4°C            | Ambient to 4°C            |
| Sample Capacity                            | 96 (96-well plate format) | 96 (96-well plate format) |
| Available Wash/Rinse Buffer Ports          | Five (5) on Autosampler   | Five (5) on Autosampler   |

| Nano ITC                 | Standard Volume          | Low Volume               |
|--------------------------|--------------------------|--------------------------|
| Minimum Detectable Heat  | 0.10 µJ                  | 0.05 µJ                  |
| Maximum Measurable Heat  | 5,000 µJ                 | 5,000 µJ                 |
| Low Noise Level          | 0.0025 µWatt             | 0.0014 µWatt             |
| Baseline Stability       | 0.02 µWatt/hr            | 0.02 µWatt/hr            |
| Temperature Stability    | 0.00005°C at 25°C        | ±0.00005°C at 25°C       |
| Temperature Control      | Active heating & cooling | Active heating & cooling |
| Operating Temperature    | 2 to 80°C                | 2 to 80°C                |
| Sample Cell Size         | 1.0 mL                   | 190 µL                   |
| Injection Syringe Volume | 100 µL & 250 µL          | 50 µL                    |
| Minimum Injection Volume | 0.12 µL / 0.26 µL        | 0.06 µL                  |
| Stirring Speed Range     | 0 to 400 rpm             | 0 to 400 rpm             |
| Response Time            | 13 Sec / 18 Sec          | 11 Sec                   |
| Cell Geometry            | Fixed Cylindrical        | Fixed Cylindrical        |
| Cell Composition         | 24K Gold / Hastelloy     | 24K Gold                 |

| Nano DSC and DSC Auto  |                              |
|------------------------|------------------------------|
| Short-term Noise       | 0.015 µWatts                 |
| Baseline Stability     | 0.028 µWatts                 |
| Response Time          | 5 Sec                        |
| Operating Temperature  | -10°C to 130°C               |
| Temperature Scan Rate  | 0.001°C to 2°C/minute        |
| Pressurization Control | Built-in up to 6 atmospheres |
| Cell Geometry          | Fixed Capillary/Cylindrical  |
| Active Cell Volume     | 300 µL / 330 µL              |
| Cell Composition       | Platinum/Gold                |
| Heat Measurement Type  | Power Compensation           |

| Automation                            |   |
|---------------------------------------|---|
| Sample Capacity                       | 490 µL/sample well/800 µL/reference well                    |
| Sample Tray Temperature Control Range | 4 °C to Ambient   |
| Available Wash/Rinse Buffer Ports     | 4 for Sample/Reference Cells; 2 for Sample Handling Syringe |

## References

- Garbett, N., DeLeeuw, L. and J.B. Chaires. MCAPN-2010-04.  
High-throughput DSC: A Comparison of the TA Instruments Nano DSC Autosampler System™ with the GE Healthcare VP-Capillary DSC™ (2010)
- Demarse, N. and L.D. Hansen. MCAPN-2010-01.  
Analysis of Binding Organic Compounds to Nanoparticles by Isothermal Titration Calorimetry (ITC). (2010)
- Quinn, C.F. MCAPN-2010-02. Analyzing ITC Data for the Enthalpy of Binding Metal Ions to Ligands. (2010)
- Quinn, C.F. and L.D. Hansen. MCAPN-2010-03. Pressure Perturbation Calorimetry: Data Collection and Fitting. (2010)
- Román-Guerrero, A., Vernon-Carter, E.J. and N.A. Demarse. MCAPN-2010-05. Thermodynamics of Micelle Formation. (2010)
- TA Instruments, Microcalorimetry Technical Note MCTN-2010-02.  
Advantages of Using a Nano DSC when Studying Proteins that Aggregate and Precipitate when Denatured. (2010)
- TA Instruments, Microcalorimetry Technical Note, MCTN-2010-03. How to Choose an ITC Cell Volume. (2010)
- Choma, C.T. MCAPN-2010-01. Characterizing Virus Structure and Binding by Calorimetry. (2009)
- Schon, A. and E. Freire. Anal. Biochem. 513: 1-6 Enthalpy Screen of Drug Candidates. (2016)
- Ross, P.C. and E. Freire. MPC-2013-03, Enthalpy Screening by Isothermal Titration Calorimetry. (2013)



**AMERICAS**

- New Castle, DE USA**
- Lindon, UT USA**
- Wakefield, MA USA**
- Eden Prairie, MN USA**
- Chicago, IL USA
- Costa Mesa, CA USA
- Montreal, Canada
- Toronto, Canada
- Mexico City, Mexico
- São Paulo, Brazil

**EUROPE**

- Hüllhorst, Germany**
- Bochum, Germany
- Eschborn, Germany
- Wetzlar, Germany
- Elstree, United Kingdom
- Brussels, Belgium
- Ettien-Leur, Netherlands
- Paris, France
- Barcelona, Spain
- Milano, Italy
- Warsaw, Poland
- Prague, Czech Republic
- Sollentuna, Sweden
- Copenhagen, Denmark

**ASIA & AUSTRALIA**

- Shanghai, China
- Beijing, China
- Tokyo, Japan
- Seoul, South Korea
- Taipei, Taiwan
- Guangzhou, China
- Petaling Jaya, Malaysia
- Singapore
- Bangalore, India
- Sydney, Australia



[tainstruments.com](http://tainstruments.com)