

Waters™



MICROCALORIMETRY: TAM IV & TAM 48



TAM IV Microcalorimetry System

All chemical, physical and biological processes are associated with a heat production or heat consumption. Conceived over 25 years ago as a Thermal Activity Monitor the fourth generation TAM is the most sensitive, stable and flexible microcalorimeter system in the world for directly measuring this universal heat signal and, therefore, the quantitative thermodynamic and kinetic observation of any process. It is a unique microcalorimeter system that is completely modular and combines the highest heat flow sensitivity with unmatched long term temperature stability for measuring many processes that are undetectable by other techniques. A wide range of calorimeter configurations and sample handling systems provide maximum application flexibility and ensure optimum laboratory productivity.

TAM IV | MICROCALORIMETRY SYSTEM



The new **TAM IV** is the world's most
SENSITIVE, STABLE AND FLEXIBLE
microcalorimeter system.

It is completely modular and combines the highest heat flow sensitivity with unmatched long-term temperature stability to measure processes that are undetectable by other techniques. The TAM IV-48 expands the TAM IV capabilities as a high-throughput microcalorimeter system that can be configured to accommodate up to 48 individual calorimeters. The power and flexibility of the TAM IV thermostat, coupled with the available calorimeters and accessories, creates a flexible, powerful analytical platform suitable for any laboratory and offers performance and sample throughput that is unmatched by any other isothermal calorimetry instrument.

TAM IV Features & Benefits:

- New and more responsive temperature control provides faster thermal equilibration and extended temperature range of 4 °C to 150 °C for real-world cold storage applications.
- Unmatched temperature stability for accurate heat flow measurement in experiments that last anywhere from a few hours to days and weeks
- Four calorimeter positions that can be equipped with up to four calorimeters, each of which operates simultaneously and independently
- Calorimeters are available in a wide variety of configurations: size, sensitivity, throughput, and ancillary sample measurement or manipulation capabilities
- New Accessory Interface box with capacity for up to eight separate accessories for unmatched flexibility
- New voltage I/O module for interfacing up to three independent probes/sources, such as pH probe or light source

TAM IV-48 Features & Benefits:

- Easy configuration of 1 to 48 microcalorimeters for high throughput, parallel sample measurements for maximizing laboratory productivity

Unique isothermal calorimetry platform for screening biologicals, energetic materials and production control testing



TAM IV



TAM IV - 48

The most **STABLE** and **PRECISE TEMPERATURE CONTROL**

The TAM IV calorimeter system efficiently and accurately controls the set temperature for the thermostat with advanced hardware and electronics. Precise temperature control and unmatched calorimeter sensitivity ensure all measurements being made will have the best stability, signal-to-noise ratio and reproducibility, even for the most challenging applications.

TAM IV Thermostat Features & Benefits:

- An oil based liquid bath system for a continuously circulated heat sink medium that prevents any thermal event in the room environment from altering the constant temperature bath or affecting any of the calorimeters
- A temperature regulation system utilizing state-of-the-art electronic thermistors and sensors to constantly adjust the heating, cooling and uniform oil flow speed for a temperature drift over 24 hours of less than $\pm 100 \mu \text{ }^\circ\text{C}$
- The continuously circulated oil acts as a heat sink medium, and provides a uniform and precise temperature environment for sample testing when operating in isothermal, scanning or step isothermal modes.

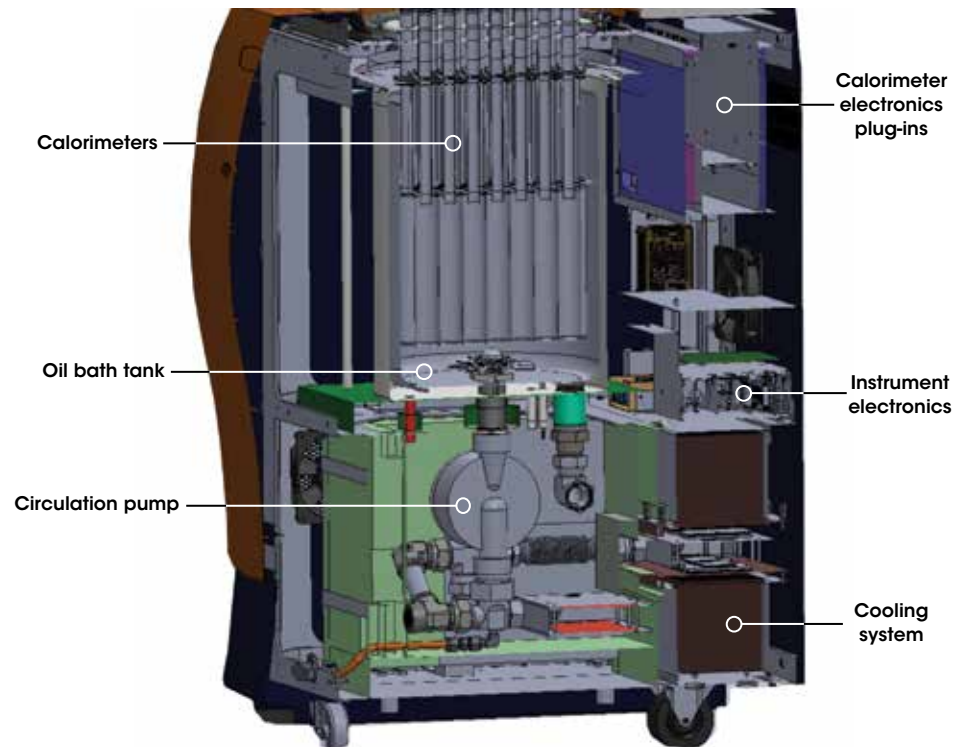

Temperature Control Features & Benefits:

Isothermal:

- Classical mode for microcalorimetric measurements
- Thermostat is maintained at constant temperature while heat generated or absorbed by the sample is measured
- Both short term and long term experiments can be accurately performed with exceptional stability and reliability

Step isothermal:

- Perform multiple isothermal temperature analyses in a single experiment
- Identical signal stability and sensitivity is achieved as in conventional isothermal experiments.
- Data recorded continuously for detecting temperature-dependent events during step temperature changes, as well as in isothermal dwells

Scanning:

- Experiments performed under extremely slow and well controlled scanning conditions provides greater resolution of phase transitions compared to conventional DSC instruments
- The slow scan rate (maximum 2 °C/h) allows large samples to be analyzed close to thermal, physical and chemical equilibrium
- The slow scanning rate allows the possibility of verifying that a reaction follows the Arrhenius relationship.

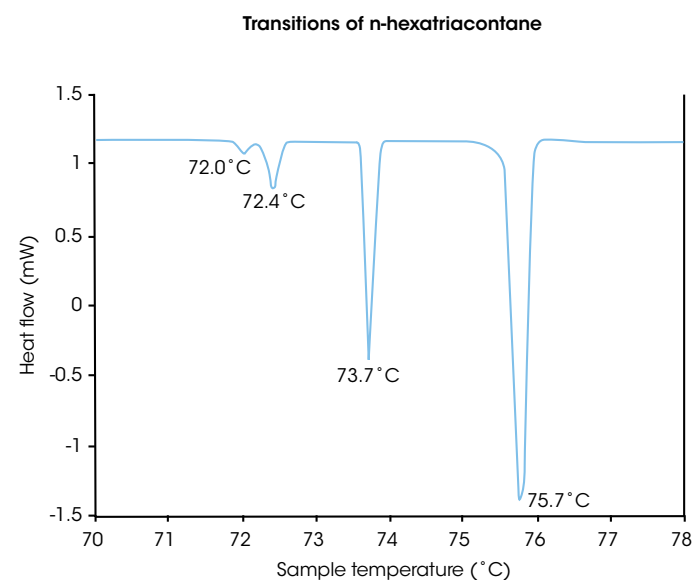

Example of slow scanning experiment resolving four endothermic transitions of n-hexatriacontane

The **BROADEST** and most **ACCURATE TEMPERATURE RANGE**

The TAM IV is designed for reliable operation at an extended temperature range of 4 °C to 150 °C. The expanded sub-ambient temperature range extends the application capability of the TAM IV to more accurately simulate low temperature conditions and accurately assess Arrhenius kinetics.

Features & Benefits:

- The TAM IV utilizes proven hardware and electronic controls to ensure stable and reliable operation from 4 °C to 150 °C
- User installable dry gas purge system ensures condensation free environment.
- User programmable temperature settings for easily and accurately characterizing biological and ecological samples at sub-ambient environmental conditions
- Low temperature range is ideal for high precision sample analysis (food, freeze-dried pharmaceuticals, batteries) at representative cold storage/operation temperatures
- Enhanced data acquisition for stability and kinetics data below the glass transition point for samples with glass transitions temperatures near ambient temperature
- Lower temperatures enable the accurate and reproducible characterization of samples exhibiting fast reaction rates with short induction times

TAM IV High Efficiency Cooling System

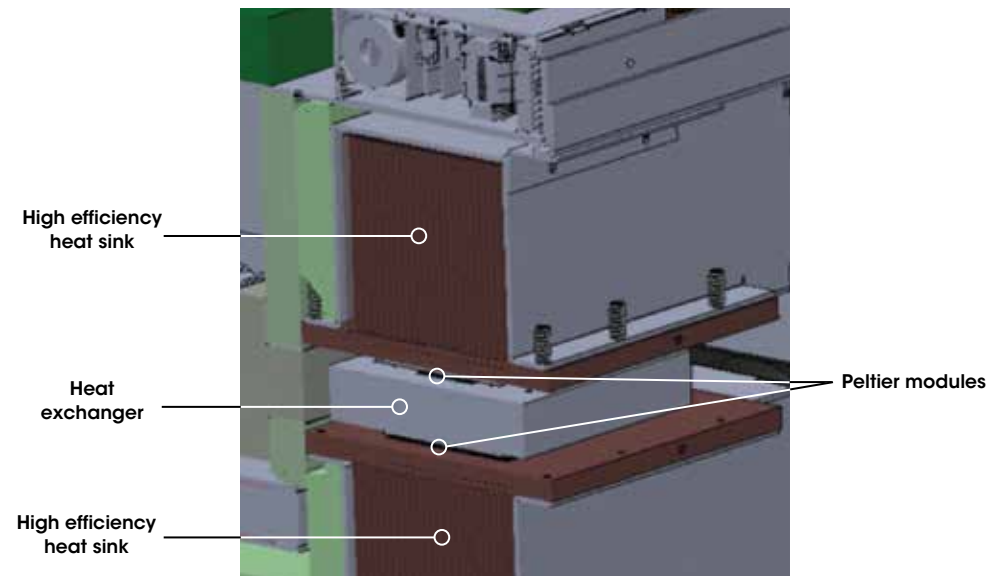

Dry Gas Envelope



TAM IV | CALORIMETERS

The primary TAM IV calorimeters are heat flow calorimeters. All calorimeters are twin type calorimeters, consisting of a sample and a reference and measuring the heat flow difference between the two positions. All installed calorimeters can operate simultaneously and independently

Feature & Benefits:

- Enables experiment optimization based on
 - sample volume
 - absolute sensitivity
 - throughput
 - addition of external stimuli and complimentary measurements such as humidity, titration, electrical potential, atmospheric pressure, and more
- Maximum sensitivity with the Nanocalorimeter and Microcalorimeter featuring user-accessible reference positions
- Optimum sample throughput with Minicalorimeters utilizing a fixed reference to reduce the space occupied by the calorimeters

Heat flow measurement

The TAM IV heat flow calorimeters are designed to facilitate the transfer of the heat produced or consumed by any process in the sample through heat flow sensors. A thermoelectric sensor responds to a temperature difference by generating a potential over the sensor, according to the Seebeck effect.

Measuring principle characteristics:

- One side of the thermoelectric sensor is in contact with the sample and the other is maintained isothermal through contact with the TAM IV thermostat via the calorimeter heat sink
- The potential is measured as a voltage signal and is proportional to the heat flow generated by the sample
- A heat flow measurement is a passive measurement and ideal for slower reactions
- Exceptional temperature stability of the TAM IV thermostat ensures that the measured heat flow values, even over long periods of time, are stable, accurate and sensitive
- A sample with a nearly-identical inert reference reduces baseline noise by eliminating the effect of any small thermostat fluctuations on the measured heat flow
- The dynamic correction mode uses the time constants of the loaded calorimeter and automatically calculates the signal using the Tian equation to resemble the process taking place in the sample
- Dynamic correction decreases the time constant 3-5 times and is recommended for rapid reactions, such as those seen in titration experiments

Sample Size



Nanocalorimeter



4 mL Multicalorimeter



Microcalorimeter



20 mL Multicalorimeter



Macrocalorimeter

Absolute Sensitivity

TAM IV | CALORIMETERS WITH ACCESSIBLE REFERENCE

The Nanocalorimeter and Microcalorimeter employ a user accessible reference and deliver the maximum in heat flow sensitivity. Heat flow measurements on these calorimeters are easily optimized by matching each specific sample condition with an appropriate reference material. The Nanocalorimeter is designed for up to 5 mL samples. The Microcalorimeter will accommodate larger samples and/or provide a larger gas phase above the sample.

Nanocalorimeter Features & Benefits:

- Achieves highest sensitivity with inert substance in user accessible reference
- Maximum sample flexibility for all static ampoules up to 5 mLs
- Compatible with 1 mL and 4 mL micro reaction systems for
 - Titration
 - Perfusion
 - RH Perfusion
- Ideal for isothermal titration calorimetry (ITC) experiments to study molecular interactions
- Compatible with the 4 mL vacuum/pressure ampoule for simultaneous collection of heat flow and pressure data
- Each calorimeter occupies only one of the four positions in the TAM IV thermostat



Microcalorimeter Features & Benefits:

- Designed for larger volume samples - accommodates 20 mL static ampoules in glass, stainless steel and Hastelloy
- Compatible with 20mL micro reaction systems for
 - Titration
 - Perfusion
 - RH Perfusion
- Uniquely designed for the TAM microsolution ampoule applications
 - Dissolution of very small amounts of solids in various solvents
 - Dissolution of slowly soluble substances
 - Heat of dissolution and kinetics of dissolution
- Compatible with the 20 mL vacuum/pressure ampoule for simultaneous collection of heat flow and pressure data
- Each calorimeter occupies only one of the four positions in the TAM IV thermostat



TAM IV | CALORIMETERS WITH FIXED REFERENCE

Minicalorimeters have a permanent reference and are designed to reduce the space occupied in the thermostat to increase sample throughput. An assembly of up to six minicalorimeters is designated as a multicalorimeter which occupies only one of the four calorimeter positions in the TAM IV thermostat.

Minicalorimeter Features & Benefits:

- Space saving over-under design allows high throughput calorimetry by maximizing the number of calorimeters that can be used simultaneously
- Permanently mounted reference inserts ensure reference is matched to selected ampoule and sample properties
- Heat sink design provides highest responsiveness to changes in the thermostat temperature – ideal choice for temperature scanning experiments
- Choice of 4 mL and 20 mL sample size for maximum sample flexibility
- Simultaneous heat flow and pressure measurements with vacuum/pressure ampoules
- Up to forty-eight 4 mL minicalorimeters for high throughput simultaneous and independent measurements in TAM IV-48

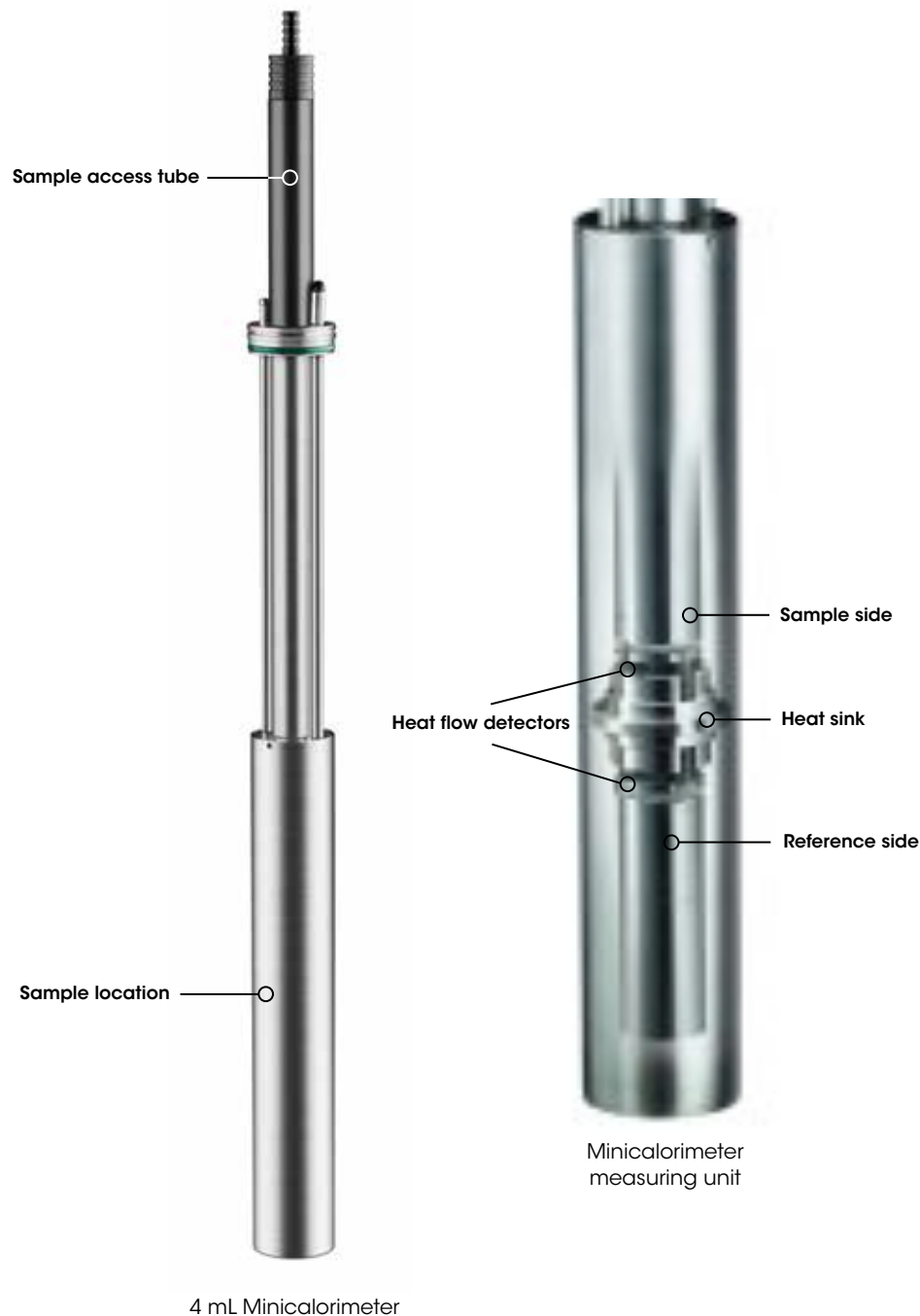

One of six sample access tubes



One of six measuring units

4 mL Multicalorimeter

One of three sample access tubes



Assembly of three 20 ml minicalorimeters

20 mL Multicalorimeter

Multicalorimeter Features & Benefits:

- 4 mL multicalorimeter - six 4 mL minicalorimeters
- 20 mL multicalorimeter - three 20 mL minicalorimeters
- Multicalorimeter assembly occupying one thermostat position increases sample throughput by three- to six-fold
- Maximum throughput and experimental design flexibility:
 - Choice of identical or different reference inserts for each calorimeter
 - Use of 20 mL vacuum/pressure ampoules

TAM IV | MACROCALORIMETER

The Macrocalorimeter is a large volume calorimeter designed for accurate heat flow measurements of samples requiring volumes up to 125 mL.

Macrocalorimeter Features & Benefits:

- Accommodates large volume glass or stainless steel ampoules when large samples are required
- Microwatt level absolute sensitivity for heterogeneous mixture samples
- Sample-above-reference design minimizes required space; occupies one position in thermostat
- User-accessible reference for easy heat capacity balance optimization
- Battery fixtures and sample holders are available for easy and accurate measurement of static discharge and charge-discharge
- Application flexibility includes:
 - Evaluation of battery component compatibility
 - Soil & sediment remediation
 - Food stability analysis
 - Whole living organism metabolism



Macrocalorimeter

TAM IV | PRECISION SOLUTION CALORIMETER (SOLCAL)

The Precision Solution Calorimeter (SolCal) makes high precision measurements of heat generated or consumed during solid or liquid dissolution processes.

SolCal Features & Benefits:

- Semi-adiabatic (isoperibol) calorimeter for heat of dissolution measurements with high accuracy and precision
 - Quantification of amorphous content in materials
 - Discrimination of crystalline forms for polymorphism assessment
- Optimized for rapid dissolution reactions that are complete within 30 minutes
- Two available reaction vessel volumes (25 mL or 100 mL) for maximum application flexibility
- Operating temperature range of 15 °C to 80 °C ensures wide range of applications
- Application flexibility includes a SolCal configuration with titration capabilities
- Occupies one position in the thermostat



TAM IV | BATTERY CYCLER MICROCALORIMETER SOLUTION

Battery Cyclers Microcalorimeter Solution

The Battery Cyclers Microcalorimeter Solution is a complete in-operando system for high-resolution thermo-electrochemical characterization of battery cells. System flexibility enables simultaneous control of multiple instruments, real time data monitoring, and advanced data analytics. The Battery Cyclers Microcalorimeter Solution is not only efficient in its design, but it reduces testing time, increase speed to decisions, and is capable of elucidating new insights of your battery cell materials.



A Full Solution to Maximize Insights

The Battery Cyclers Microcalorimeter Solution has a new integrated software platform that enables full hyphenation of the TAM IV Isothermal Microcalorimeter and the VSP-300 Potentiostat/cycler* for seamless in-operando experimental control and data analysis. This fully hyphenated technique enables users to elucidate the chemical details of their battery cell system, to formulate electrolytes with greater accuracy without sacrificing time. The solution provides non-destructive, in-operando testing to drastically reduce experiment time while generating data for valuable insights that influence decisions to develop batteries with greater efficiency, safety, and stability.

*You can find more information on the Bio-Logic/BioLogic VSP-300 Potentiostat/Cycler on our partner website at www.biologic.net



VSP-300 Potentiostat

- Up to 6 channels
- 500mA to 10nA, 760fA resolution
- +/- 10V control voltage
- EIS 10uHz to 7MHz



Features and Benefits:

- **Integrated software** eliminates technical barriers for faster workflow. The VSP-300 Potentiostat data coupled with the TAM IV Isothermal Microcalorimeter data are both collected and analyzed in one user interface, making it easy to run experiments and analyze results.
- **Immediate real-time data aggregation** precludes users from having to wait for lengthy experiments to complete before viewing initial results.
- **Accommodates three common battery types and multiple sizes**, allowing researchers to achieve better data across multiple configurations and chemistries and saving months of experimental time for varied set ups.
 - Coin Cells (CR2032 and CR2325)
 - Cylindrical Cells (18650)
 - Pouch Cells (up to 50 mm x 94 mm)
- **Highest throughput** with the ability to cycle up to 12 concurrent battery samples at a time offering a drastic reduction in experimental time and long waits to confirm battery fidelity.
- **Reduced experiment and training time** with efficient experimental design and software capabilities.
- **Plug and Play calorimeter battery lifter technology** is user friendly eliminating the need for specialized engineering and risks associated with conducting unsafe practices by the customization of OEM products.

Battery Testing Accessories

Battery Cycler Microcalorimeter options comprise three individual prewired lifters to support testing three corresponding common battery types (coin, pouch, and 18650 cylindrical) in a variety of sizes. Internal wiring allows the battery cell samples to be directly connected to the appropriate external load or charge/discharge device for tandem thermo-electrochemical testing. In conjunction with the BioLogic VSP-300 simultaneously monitoring of the electrochemical and thermoanalytical data is enabled through the integrated TAM ASSISTANT software.

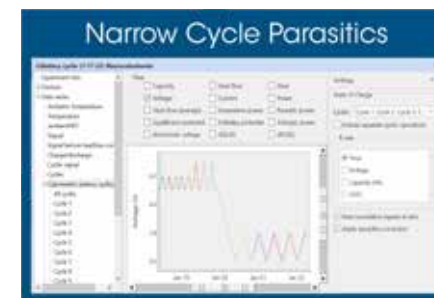
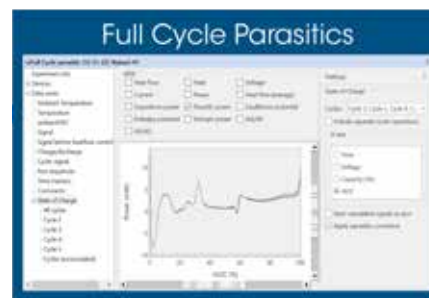
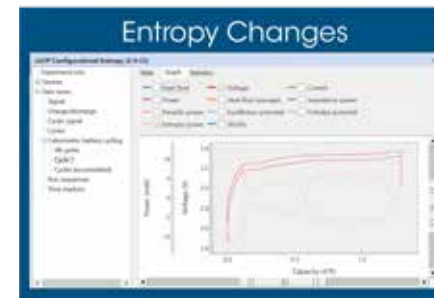

The Coin Cell Battery Lifting Tool

The Coin Cell Battery Lifting Tool is designed for testing CR2032 and CR2325 coin cell batteries in the TAM IV 20 mL Minicalorimeter or the TAM IV 20mL Multicalorimeter. Spring loaded contact connectors easily and safely attach a coin cell sample.

The 18650 Cylindrical Battery Lifting Tool

is designed for testing 18650 battery cells in the TAM IV Macrocalorimeter. The solder-free and thermally connected insertion pocket allows for a perfect battery fit for the 18650-battery cell sample.

The Pouch Cell Battery Lifting Tool

The Pouch Cell Battery Lifting Tool is designed for testing pouch cells with maximum dimensions of 50 mm x 94 mm in the TAM IV Micro XL Calorimeter. It features an adjustable solder-free, locking connection to attach a pouch cell sample of multiple sizes easily and safely.



Coin Cell Battery Lifting Tool



Cylindrical Battery Lifting Tool



Pouch Cell Battery Lifting Tool

TAM IV | SAMPLE HANDLING-STATIC AMPOULES

Static sample handling ampoules provide an appropriate environment for many types of samples and are critical to a well-designed calorimetric experiment. Static ampoules, also referred to as closed or sealed ampoules, contain the sample with no manipulation during the measurement.

Static Ampoules Features & Benefits:

- Static isothermal measurements are non-destructive and non-invasive to enable accurate post-calorimetric analysis
- Sealed disposable ampoules ideal for high throughput, routine measurements
- Range of ampoules provide flexibility and choice based on expected experimental conditions
 - Chemical interactions and/or pressure development
 - Choice of disposable or reusable ampoules
 - Available volumes: 1, 3, 4, 5, 20 and 125 mL
 - Ampoule composition: glass, stainless steel and Hastelloy
 - Sealing techniques: crimp seal, heat seal, screw cap and circlip cap
 - Sealed with microhygrostat for user defined relative humidity
- Static ampoule applications include:
 - Stability, compatibility and safety assessment
 - Monitoring reaction kinetics and curing
 - Assessing polymorph stability and amorphicity
 - Detection of microorganism growth



Pharmaceutical



Soil/Plant



Chemistry



Static Ampoule Application - temperature dependent reaction rates

Example of heat flow measurements at increasing temperatures of a drug and starch mixture after compression into a tablet during excipient compatibility screening. Rate of reaction increases as the temperature increases.

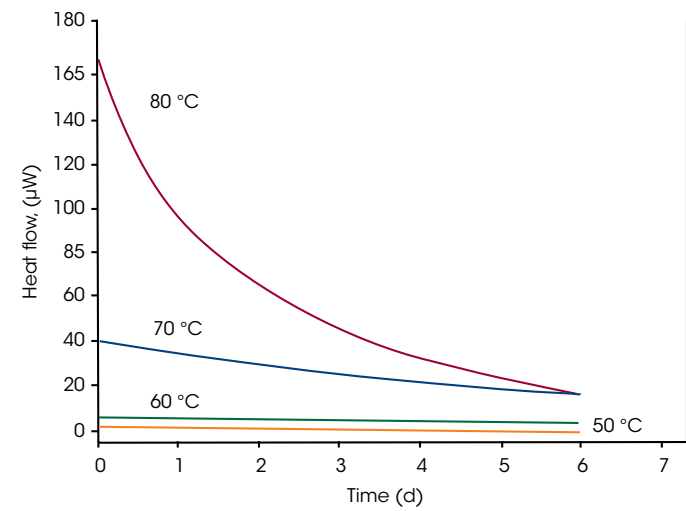

TAM IV | SAMPLE HANDLING-MICRO REACTION SYSTEMS

The micro reaction system (mrs) consists of open ampoules and accessories, such as syringe pumps or mass flow controllers, allowing for the direct manipulation or modification of the sample or its environment during the experiment.

Micro Reaction System Features & Benefits:

- Open ampoules allow for the widest range of sample manipulations
- Controlled addition and mixing for titration experiments and studying dissolution characteristics
- Perfusion of gas or liquid over sample for absorption/adsorption studies
- RH Perfusion for assessment of samples with user programmable changing moisture levels
- Vacuum/Pressure ampoules for accurate measurement of pressure changes simultaneously with heat flow measurements
- Easy access points for insertion of probes into sample for powerful integrated multiple signal measurements through user provided probes for monitoring pH, O₂, or turbidity concurrent with heat flow



Gas or Liquid
Perfusion

RH
Perfusion

Titration

Features & Benefits:

- Easy configuration and operation of micro reaction systems with TAM Assistant software thru a multi-channel accessory interface
- TAM IV thermostat will accommodate multiple accessory interfaces for maximum throughput and flexibility
- Up to eight (8) identical or different accessories connected and controlled thru one accessory interface for unmatched flexibility
- Easy configuration of syringe pumps and stirring controls for titration ampoules
- Peristaltic pump or mass flow controller ensures reliable flow for liquid or gas perfusion
- New three channel voltage I/O accessory card for applying or measuring voltage from user configurable probes (pH, O₂, etc.)



Accessory Interface Box



Pump
Accessory

Syringe & Stir
Accessory

Gas Flow
Accessory

Voltage
I/O

Isothermal Titration Calorimetry (ITC) is a powerful analytical technique for characterizing a wide range of molecular interactions as well as enzyme and chemical kinetics. The ITC reaction systems can be used for injecting one sample into another, such as creating a bioassay for the study of cell metabolism when a drug is injected into a living cell culture. The removable ampoule design of the TAM ITC system provides maximum flexibility to accommodate a wide variety of ITC applications.

ITC Features & Benefits:

- Sensitivity level as low as 10 μJ for low heat reactions
- Reusable titration ampoules available in 1, 4 and 20 mL volumes for maximum application flexibility
- Optimize experimental set-up with titration ampoules available in glass, stainless steel or Hastelloy
- User selectable impeller designs for optimizing mixing while minimizing potential disruption to the sample's structural integrity
- User selectable ITC injection syringes of 100 μL to 2.5 mL volumes
- High precision syringe pump accurately delivers required titrant volume in discrete aliquots or as a single continuous injection
- Syringe pump assembly will accommodate two identical or different volume syringes for addressing complex simultaneous multi-ligand titrations

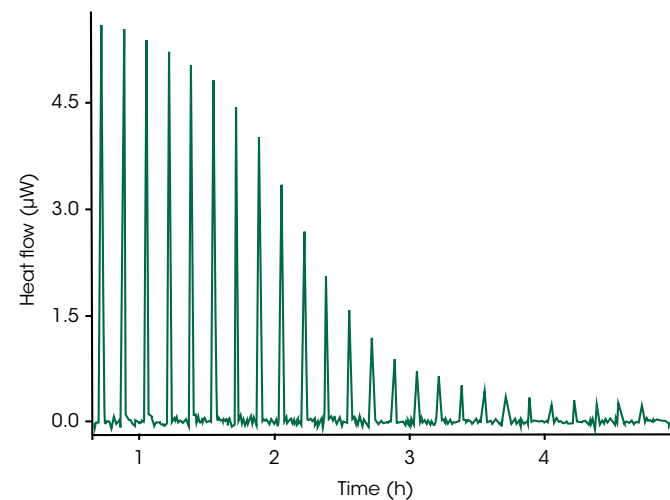

Example of titration of ligand into target molecule

Features and Benefits:

- ITC performed in a TAM IV calorimeter will accommodate a wide variety of sample configurations
 - Solids or powders
 - Suspensions
 - Aqueous and organic solvents
 - Biological and non-biological samples
- Widest range of ITC applications easily configured for TAM IV ITC
- Complete thermodynamic characterization of solid or liquid molecular interactions
- Determining thermodynamic binding profiles in one experiment
- Accurate determination of mixing enthalpy
- Ideal technique for determination of dissolution kinetics
- Unique hardware and software capabilities for absorption and swelling measurements
- Maximum sensitivity and sample flexibility for dose-response drug sensitivity assays on viable living cells
- Precision control of titrant delivery for accurately characterizing enzyme and chemical kinetics



TAM IV | MICRO REACTION SYSTEMS - PERFUSION

The TAM IV perfusion micro reaction system is a unique configuration for the continuous flow of a gas or liquid through or over the sample being assayed. With the more complex RH perfusion experimental set-up, an RH perfusion ampoule and gas flow controller are configured together to deliver a controlled stream of gas with a user defined relative humidity over the sample.

Perfusion Features & Benefits:

- A liquid or gas is continuously perfused through the ampoule for the study of adsorption, absorption, hydration and swelling
- Optional gas flow controllers ensure easy experimental set-up and enables stability and compatibility measurements under controlled atmospheric conditions
- Optional peristaltic pumps are easily configured for experiments requiring a continuous flow of a liquid
- User choice of reaction vessels in glass, stainless steel and Hastelloy - 1, 4 and 20 mL volumes
- Matrix cartridge holds sample in flow path and maximizes the available surface area for powder sample interactions
- Easy set-up and experiment control with both the gas and liquid flow systems controlled directly via TAM Assistant software
- User configurable stirring and injection capabilities expands the experiment set-up options for unmatched flexibility
- Choice of Nanocalorimeter or Microcalorimeter, depending on sample requirements

Oxidation of a Polyamide

Oxidation of a Polyamide 6 film studied by gas perfusion calorimetry at 110 ° C. Two Perfusion ampoules were loaded with the same amount of an unstabilized PA 6 film. The first ampoule was perfused with nitrogen and the other one with oxygen and the heat flow was followed for 4 days. The sample under oxygen atmosphere shows a high reaction rate similar to an autocatalytic reaction with no observed induction time. After 4 days the gases were switched, i.e. nitrogen flushing through the first ampoule was replaced with oxygen and oxygen flushing through the second ampoule was replaced with nitrogen. The immediate response when changing the gases clearly shows that the heat flow monitored by TAM is associated with oxidation.

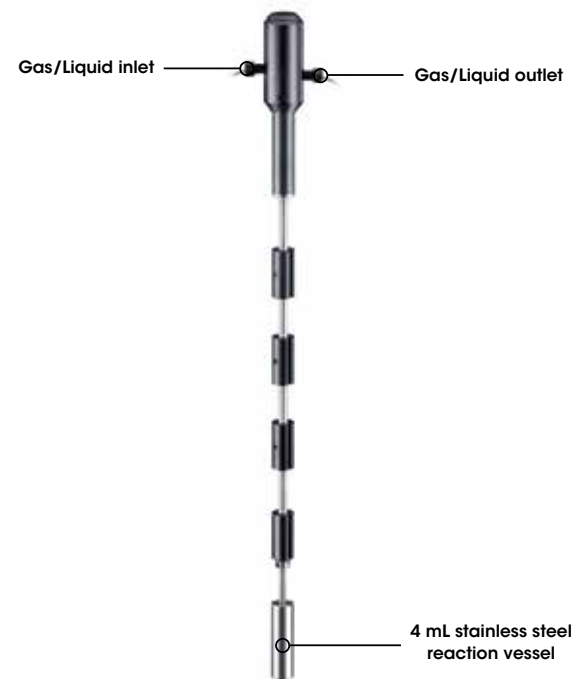

4 mL Perfusion Calorimeter

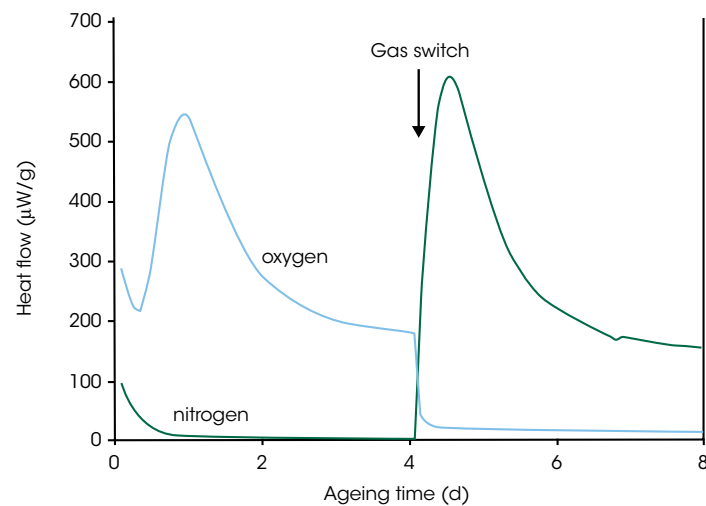

RH Perfusion Features & Benefits:

- RH Perfusion reaction vessels available in glass, stainless steel and Hastelloy - 1, 4 and 20 mL volumes
- Easy, user programmable experimental setup with two gas flow paths to the sample
 - one at 100% RH and one completely dry
- Two built-in humidifying chambers on the ampoule are thermostated to the measuring temperature to ensure 100% saturation of vapor
- User selectable gas mixing to achieve a linear RH ramp or a step change in RH
- All ampoules are compatible with aqueous and organic solvents for use in harsh matrix conditions
- Easiest experiment set-up and data acquisition with both the overall gas flow rate and the relative humidity controlled directly via the TAM Assistant software
- Choice of Nanocalorimeter or Microcalorimeter, depending on sample requirements
- A highly sensitive technique for
 - Determining sample amorphicity
 - Measuring sample stability and component compatibility
 - Characterizing adsorption, absorption, hydration and swelling

RH Perfusion: increasing humidity

Continuous slow increase in humidity over micronized lactose. Several events/transitions can be distinguished: (1) Adsorption of water and molecular rearrangement of the sample/water. (2) Crystallization of the amorphous part of the sample. (3) Expulsion of water from the newly created crystal lattice. (4) Polymorph transformation.

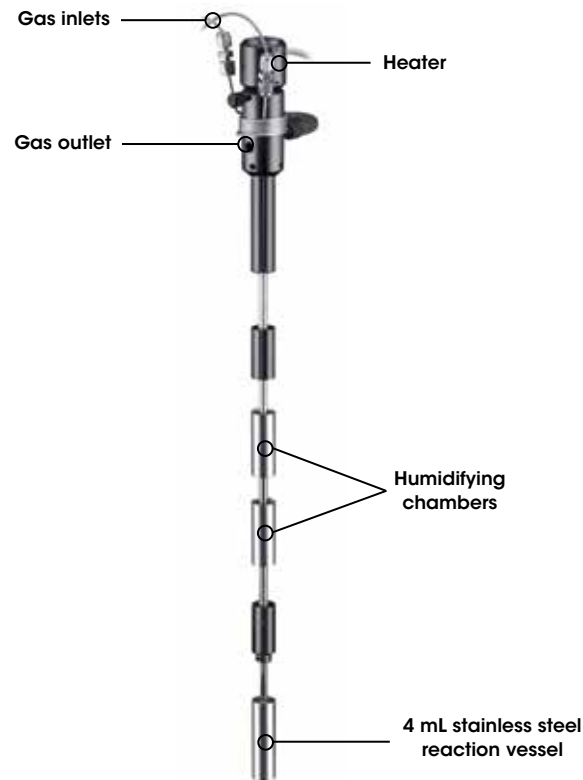

4 mL RH Perfusion Calorimeter

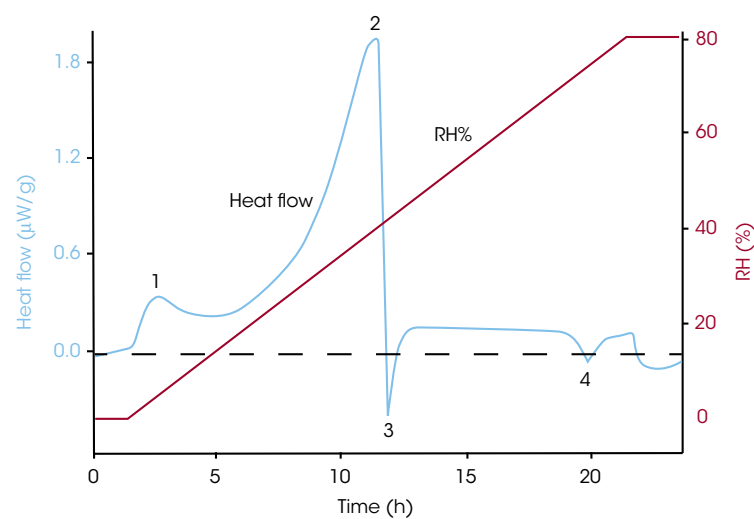

TAM IV | MICRO REACTION SYSTEMS - VACUUM/PRESSURE

The vacuum/pressure ampoules are designed for simultaneously monitoring heat flow and any changes in gas pressure in the ampoule.

Features & Benefits:

- Simultaneous measurement of heat flow and pressure up to 10 bar offers reliable safety assessment information on unstable energetic systems
- Built-in relief valves for safe measurements
- Choice of Nanocalorimeter (4 mL) or Microcalorimeter/Multicalorimeter (20 mL), depending on sample requirements
- Optional ampoule holding scaffolding and manifold for easy manipulation or management of initial pressure or vacuum above sample
- Instrument of choice for performing standard methods for energetic material testing
 - Explosives & propellants
 - Percarbonates
 - Volatile organic solutions
- Highest sensitivity for detecting even small amounts of evolved gas

Example: Energetic Material Heat flow & Pressure

Heat flow and pressure development are important considerations in evaluating storage safety and stability for materials such as percarbonates, explosives, propellants and other unstable materials that generate gaseous byproducts during decomposition. The vacuum/pressure ampoule permits simultaneous measurement of heat flow and sample pressure in a closed system. The accompanying plot illustrates the heat flow (red) and resulting pressure increase (blue) associated with the decomposition of sodium percarbonate.

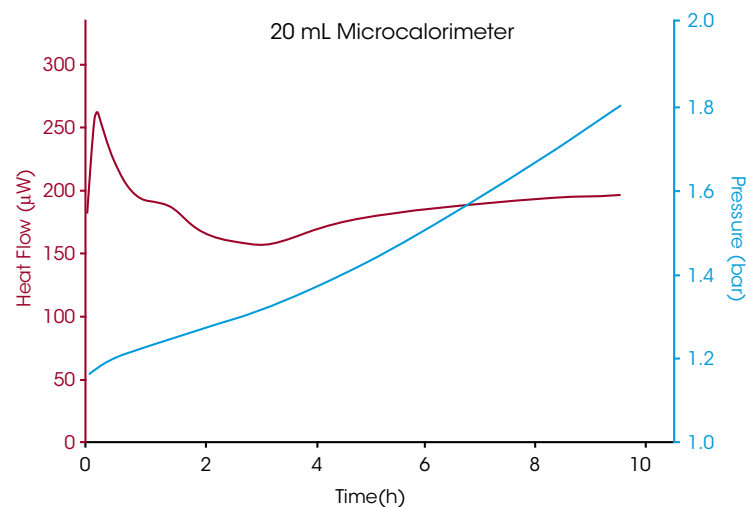
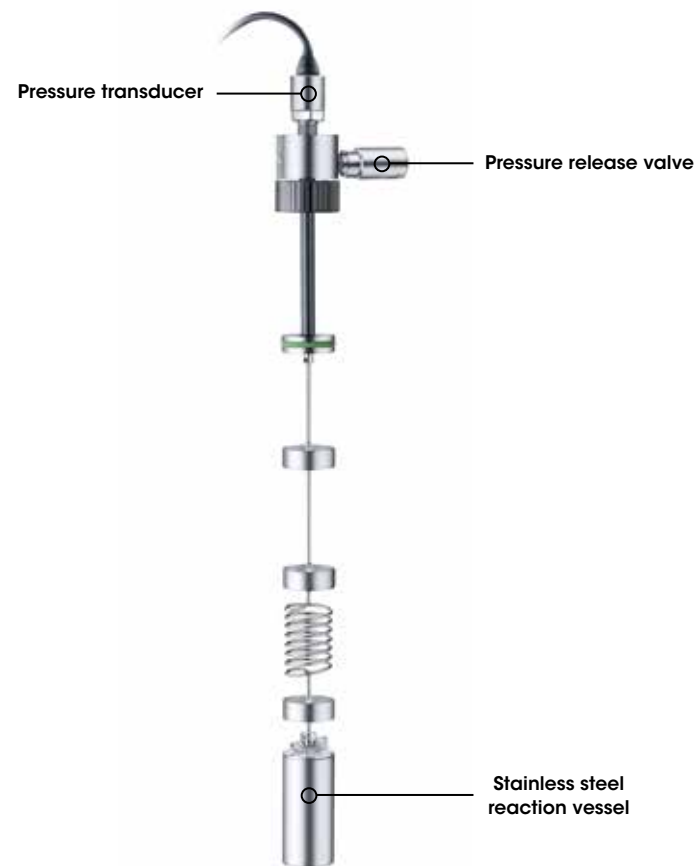

TAM IV | MICRO REACTION SYSTEMS - SOLUTION CALORIMETRY

Solution calorimetry is a powerful technique for characterizing heat transfer between molecules and understanding dissolution phenomena. Two configurations are available: Precision Solution Calorimeter (SolCal) or the Microcalorimeter with a microsolution ampoule.

Solution Calorimetry Configurations

Features	SolCal	MicroSolution ampoule
Sample Amount (mg)	50-500	< 10
Solvent Volume (mL)	25 or 100	~16
Length of dissolution process	< 30 min	Hours to days
Number of samples per run	1	3
Calorimeter type	Semi-adiabatic	Heat flow
Sample ampoules	1.1 mL crushing ampoules, with rubber stopper or heat sealed	Injection cartridge, opens up upon injection
Sample types	Liquid and solids	Solids
Measurements	Heat of dissolution, dilution and wetting	Heat of dissolution, dilution and wetting, dissolution kinetics

Features & Benefits:

- Highest accuracy and precision provided with SolCal
- Choice of 25 mL or 100 mL SolCal volumes depending on sample requirements
- Microcalorimeter with microsolution ampoule is easily configured for long term dissolution experiments

Schematic of heat of transfer

Calculations of the enthalpy of transfer between two polymorphs from the heats of solution. By measuring the heat of solution of two different polymorphic forms, it is possible to calculate the transformation enthalpy ($\Delta_{\text{trans}}H_m$) for the transition of form A to form B by taking the difference in the heat of solution between the two forms ($\Delta_{\text{sol}}H_{m,A}$ and $\Delta_{\text{sol}}H_{m,B}$). The direction of the transformation (A to B or B to A) is an indication of the relative stability of the pair and is more likely to occur if the transformation enthalpy is negative (exothermic).

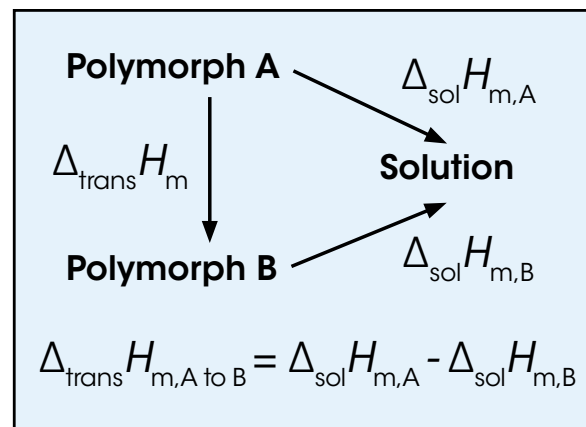

TAM IV | MICRO REACTION SYSTEMS - BATTERY TESTING

Calorimetry is an effective method for evaluating the stability and efficiency of batteries, both in static open-circuit storage conditions and under active closed-circuit charge-discharge processes. TAM IV has the sensitivity and stability to measure the low energy self-discharge event, the dynamic thermal range to measure the energetic charging process, and the flexibility to accommodate circuits for direct representative measurements.

Features & Benefits:

- Unmatched sensitivity and stability for low heat, self-discharge measurements
- Sub-ambient temperature range enables stability measurements at low temperature storage conditions, permitting the most accurate simulation and prediction of battery shelf life
- Optimal thermal contact thru a range of fixtures for cylindrical batteries up to D-Cell size
- Optional calorimeter lifters with wires and connectors for attaching an external electrical load or charging cycler
- Choice of sample volumes for effectively testing medical device batteries, subassemblies or completely sealed assemblies



Features & Benefits:

- Maximum flexibility with optional calorimeter sample lifter that will accommodate wires for connecting to load or charge cycler.
- 20 mL Microcalorimeter or Multicalorimeter easily configured for smaller coin-shaped or irregular battery designs
- Fast, easy characterization of battery stability and performance with simultaneous measurement of heat flow and voltage during static discharge or charge/ discharge cycles

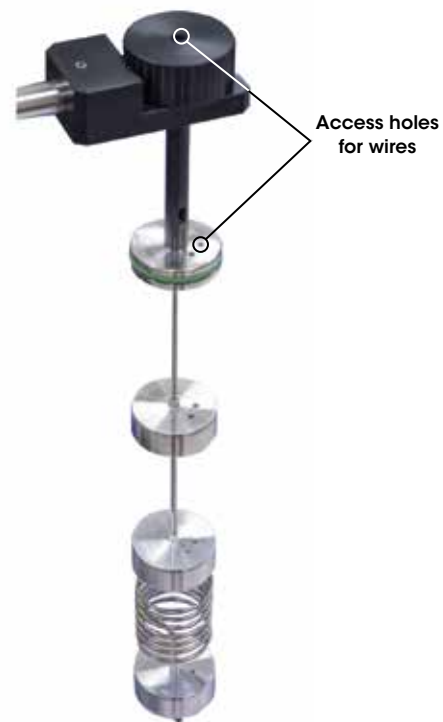

20 mL Battery Lifter

Battery Discharge Under Load

Typical TAM IV heat flow data from two batteries connected to an external load. The heat flow and voltage are measured simultaneously. The heat flow signal (red) starts low and increases as the efficiency drops as seen by decreasing voltage signal (blue).

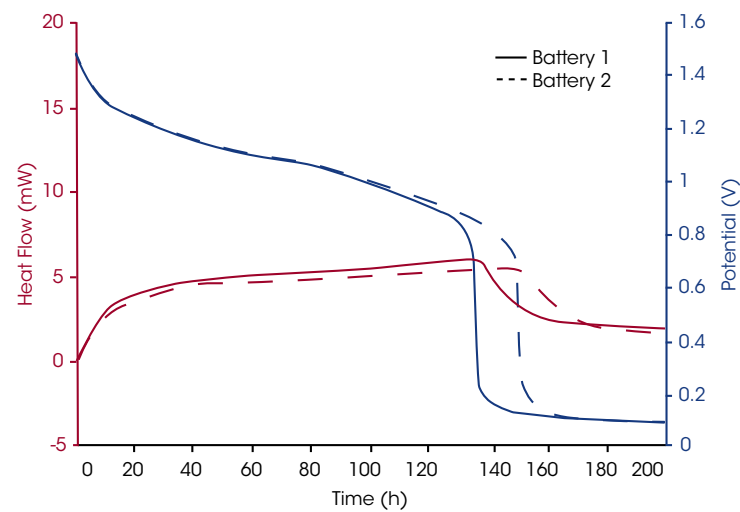

PHARMACEUTICAL | APPLICATIONS

Pharmaceutical Stability Testing

Isothermal calorimetry can be used to obtain reliable stability data within hours or days and under near ambient storage conditions. Data can be obtained closer to ambient conditions than other techniques such as UV-visible spectrophotometry. Conventional stability screening methods such as HPLC often take several weeks or months to obtain reliable data.

Isothermal heat flow measurements of pharmaceuticals are a fast and reliable way to characterize the stability of a drug and its formulation. Isothermal calorimetry can detect both chemical and physical changes within a sample, both being critical for the performance of the pharmaceutical.

Chemical degradation is conventionally studied by HPLC, which has the drawback of being relatively insensitive to small changes in concentration. In order to accelerate any degradation reactions taking place in the sample and shorten the analysis time, elevated temperatures are often used. The data generated when using such accelerated time lines typically require extrapolation to predict the stability at the temperature selected for storage.

Due to the temperature range and high sensitivity of the TAM IV microcalorimeter system, accelerated conditions are not required. The stability of the TAM IV thermostat allows even the very slow reaction rates to be detected and accurate and reproducible stability measurements can be made at or close to typical pharmaceutical storage conditions. The data generated in a TAM IV avoids the inherent errors encountered when extrapolation of data is required. Thus, microcalorimetry is particularly useful for quantifying very slow reaction rates.

The example shows the oxidation of dl- α -tocopherol at different temperatures (50 °C, 40 °C, 30 °C and 23 °C). As the temperature increases, the heat flow curves get larger in magnitude, i.e. the rate of reaction increases. The heat flow data was fitted for first order kinetics and the rate constant was plotted in an Arrhenius relationship together with HPLC data on the oxidation product. The TAM data (circles) and HPLC data (triangles) fall into the same linear Arrhenius relationship, indicating it is the same reaction being detected, although TAM is capable of detecting the reaction at much lower temperatures.

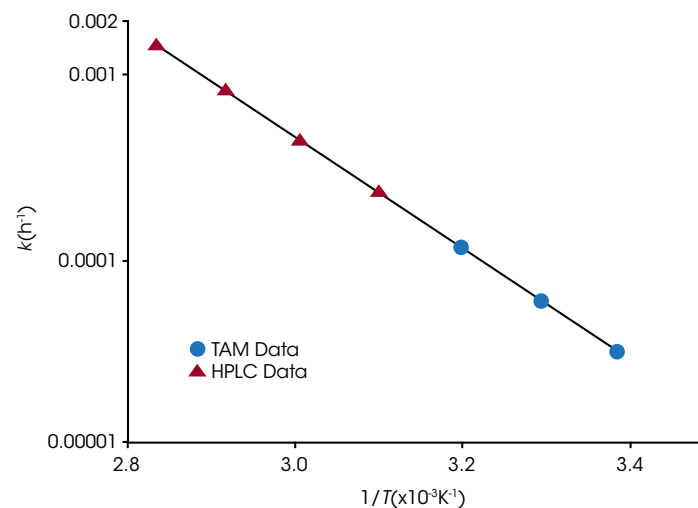
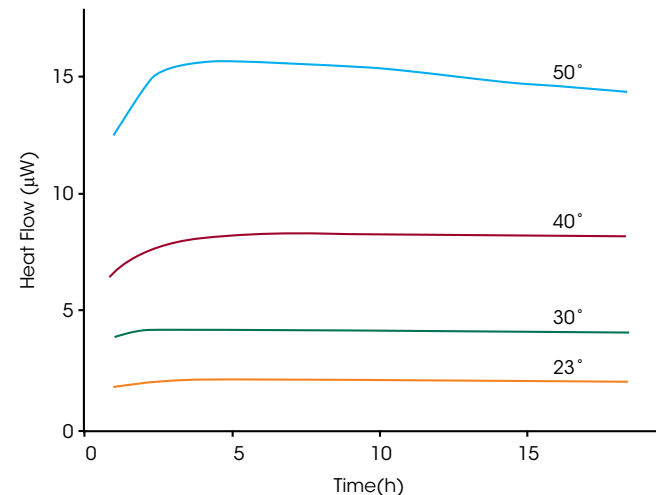

Pharmaceutical Drug-Excipient Compatibility

The TAM IV is an ideal screening tool for pharmaceutical compatibility trials. Like stability screening, compatibility screening can be performed at or close to ambient temperatures and humidity without the need to physically alter the sample prior to analysis. A calorimetric experiment typically takes only a few hours, as opposed to conventional HPLC which can take many weeks or months. The plot shows the stable heat flow from an active pharmaceutical ingredient and the microcrystalline cellulose excipient, each measured separately. The negligible measured heat flow of each material individually indicates that each material is stable in isolation. The mixture of the two components, however, results in a 6 μW heat flow caused by an incompatibility of the two materials.

Temperature dependence of Drug-Excipient incompatibility

This data set demonstrates the temperature dependence of reactions that take place due to incompatibilities. The data shows the response of an amine-lactose interaction at different temperatures. The amine and lactose are very incompatible together. Only a small response was seen at 30 °C with an increasing signal as the temperature of measurement is increased to 40 °C and 50 °C. The inset Arrhenius plot confirmed that all three temperature points fall on a straight line, which is a strong indication that the same process is happening in all three experiments.

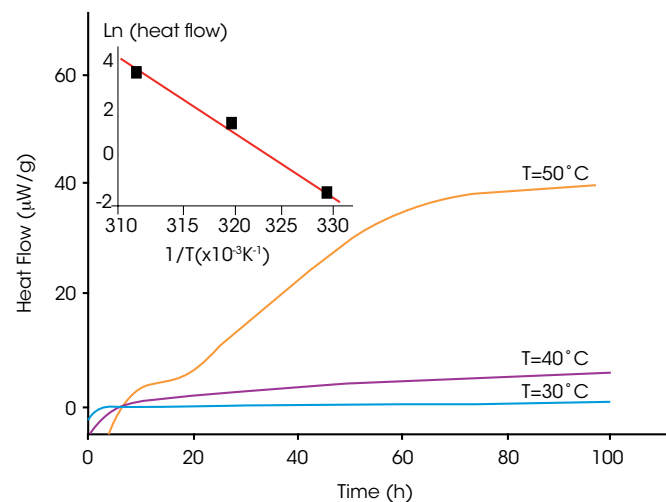
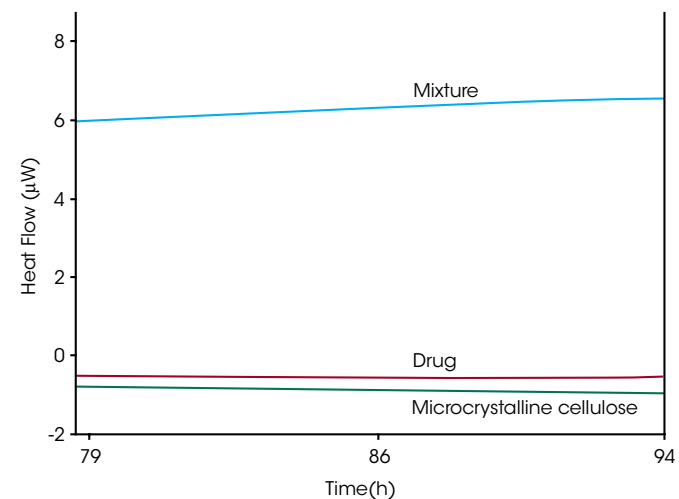

PHARMACEUTICAL | APPLICATIONS

Amorphicity & Crystallinity

Micronization and processing can alter the surface properties of materials. Small amounts of amorphous material are often formed which may change the characteristics of the powder in a way that affects both processing and bioavailability. TAM IV is an excellent tool for characterizing low levels of amorphicity in a solid. There are three calorimetric approaches: The microhygrostat method, the controlled relative humidity perfusion method and the solution calorimetry method.

Quantification of amorphicity- microhygrostat method

The sample is loaded into an ampoule and then exposed to water (or other solvents) vapor by the use of a microhygrostat with a saturated salt solution giving the desired relative humidity. The solvent lowers the glass transition temperature of the amorphous material enough to induce crystallization, which is monitored as an exothermic response in the microcalorimeter, as shown in the upper figure. By integrating the curve, the amount of amorphous material in the sample can be quantified to levels around 1%.

Quantification of amorphicity-controlled relative humidity perfusion method

This approach to detect small levels of amorphicity is the most sensitive calorimetric method, where amorphous contents approaching 0.1% can be determined. A small amount of sample is loaded into an RH perfusion ampoule and then exposed to either a continuously increasing humidity or a stepwise increase and decrease in relative humidity. In the example shown, the RH was changed between 30 and 40 %. The signal on the increase comes from absorption of water and crystallization of the amorphous material. When the RH is set to 30 %, desorption is measured and in the next increase to 40%, only absorption is measured. The difference between peak 1 and peak 3 is a measure of the crystallization heat and can be used to calculate the amorphous content in the sample.

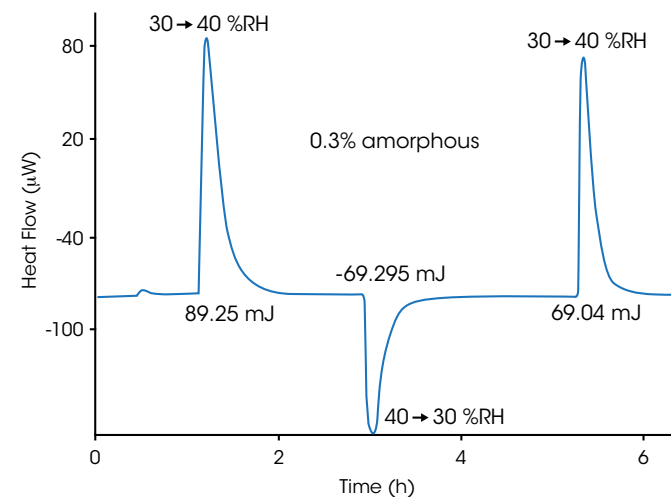
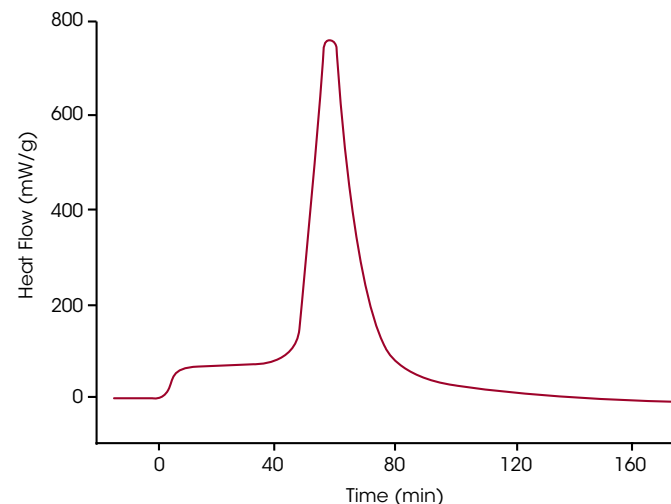

Quantification of amorphicity – solution calorimetry

Solution calorimetry is an alternative to heat flow microcalorimetry in the assessment of amorphicity. This method works by dissolving the solid material in a solvent and measuring the temperature rise or fall in the solvent as a result of dissolution. Since amorphous and crystalline materials will have a different heat of dissolution, solution calorimetry can be used to quantify the amount of amorphous material in a mixture of the two.

The solution calorimetry method is useful for materials where crystallisation of the amorphous regions is not possible. It also measures the amorphicity of the whole particle and not only the surface accessible parts.

The first figure shows the solution calorimetry data for a 5% amorphous fraction of lactose. The y-axis shows temperature offset from the bath temperature which was 25 °C. The central “break” section shows the temperature decrease as a result of dissolving the sample in water. The other two steep transitions on either side are calibrations. The second figure is a calibration curve, where the enthalpy of solution is plotted versus amorphous content and demonstrates the ability of the solution calorimeter to effectively measure lower levels of amorphicity.

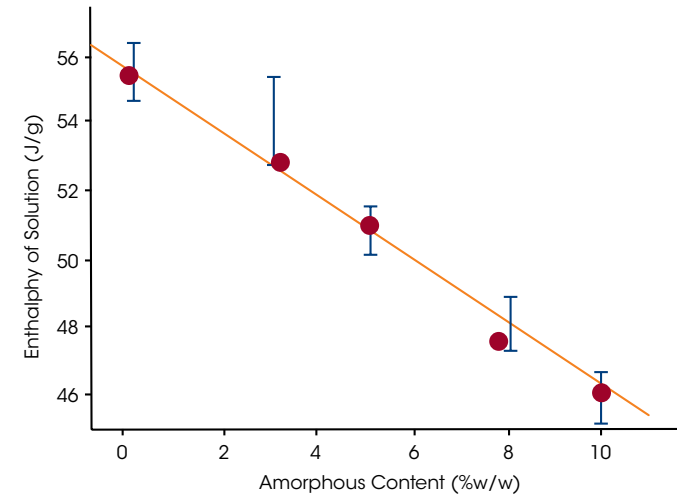
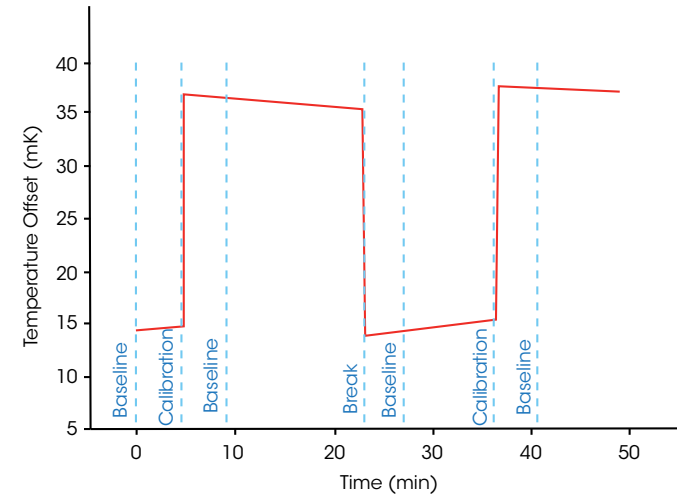

Polymorphism

An estimated 80% of pharmaceutical compounds exhibit polymorphism, which can manifest itself as a metastable crystalline form. Screening for polymorphism is important because polymorphic transformations have been shown to affect the bioavailability of a compound. The selection of the appropriate crystalline form requires a thorough and systematic approach to polymorphism screening. While a lack of chemical change can pose a problem for many analytical probes, TAM can be used to successfully monitor this type of process continually over time at or near typical storage temperature. This figure illustrates the isothermal transformation of α -tripalmitin to β -tripalmitin at 35 °C over 50 hours. The green line shows the calculated results from powder X-ray diffraction, and the blue line shows heat flow. TAM data clearly mimics the calculated data from X-ray diffraction and does so continuously throughout the course of the reaction.

Solvent mediated polymorphic transformation

Polymorphic transformations can occur via two distinct mechanisms. One mechanism is via molecular rearrangements in the dry state and the other is via a solvent phase, i.e. solvent-mediated polymorphic transformation. The solvent mediated process increases the rate of the process and works by adding a small amount of solvent to the sample. The least stable polymorph will be dissolved into a saturated solution and will crystallize into the more stable form. This reaction will continue until the sample has been completely transformed. The plot shows the polymorphic transformation for different lots of a drug that have been generated with different processes, blue: lot A, green: lot B, red: micronized lot A. The calculated enthalpies are the same, but the reaction rates are different due to differences in the stability of the samples.

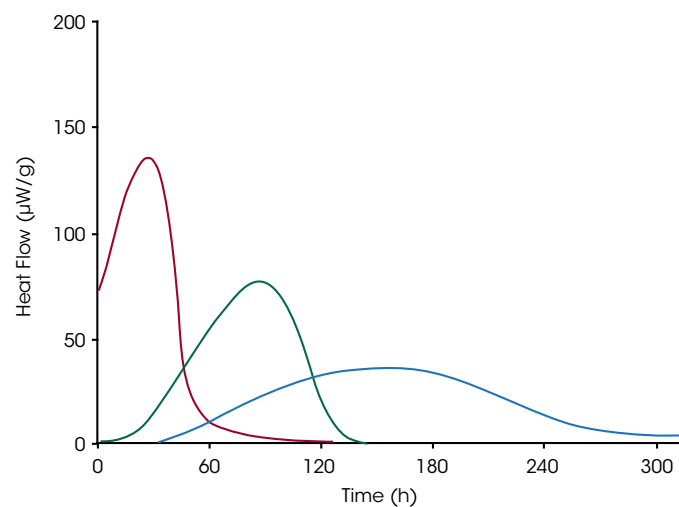
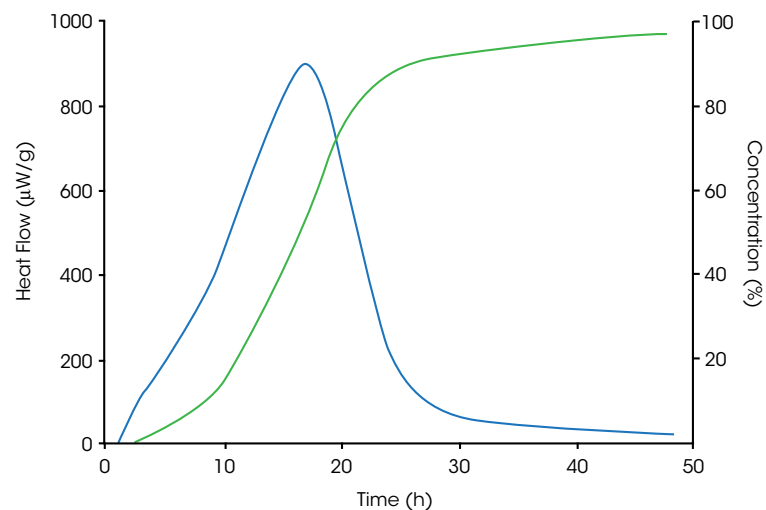

Hydrate formation in Ethinyl Estradiol

This example shows the humidity dependent hydrate formation in Ethinyl Estradiol. The sample has been exposed to various levels of relative humidity with the use of microhygrostats (blue 100%, red 95 %, green 88 %). The resulting data clearly shows that the reaction is faster with higher RH.

Heat flow data is related to the rate of reaction, while, the integrated heat flow data is related to the extent of the reaction. A plot of heat flow versus time can be fitted to a kinetic model and the rate constant determined.

The rate constant is plotted against the relative humidity and the critical humidity for this reaction can be determined, (inset in upper plot) i.e. no hydrate will be formed at relative humidities below 84%.

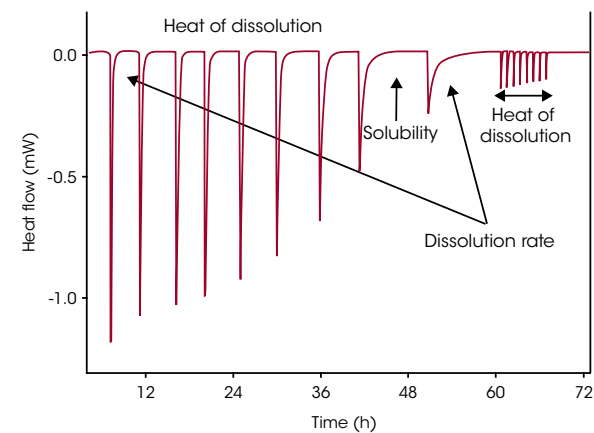
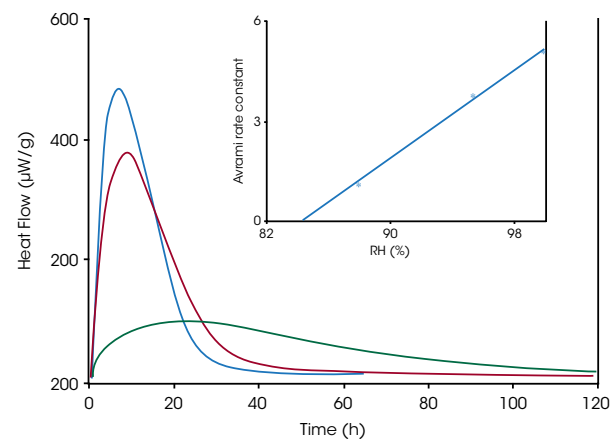

Determination of solubility

For any new drug it is important to determine the solubility to optimize the formulation and the administration of the drug. Isothermal titration calorimetry can be used to determine solubility with high precision, even for compounds with very low solubility. The example shows the solubility determination of glycine in water. A saturated solution of the sample is placed in the titration ampoule and small amounts of solvent in discrete injections are added to the solution. The first injections show the heat of dissolution. After the solubility concentration has been reached the heat of dilution is measured. The lower plot is heat per injection vs sample in added amount of total solvent.

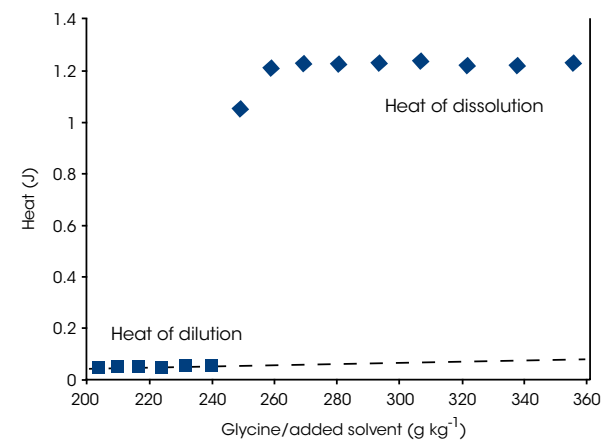

STABILITY AND COMPATIBILITY | APPLICATIONS

Stability of propellants by STANAG 4582

The evaluation and characterization of the stability of propellants is easily carried out in a TAM IV following the STANAG 4582 method. STANAG 4582 describes how to test and quantify propellant stability using calorimetry. Selecting a test temperature (60-90 °C) will determine the length of the test (usually a few days at 90 °C to months at 60 °C). During the prescribed evaluation time, the maximum heat flow from the sample must not exceed the upper heat flow limit as described by the method. This method may also be used for quality control and surveillance testing, in which case the total assay time can usually be shortened by 30%. The example in the figure shows data collected from a very stable propellant sample. The heat flow never reaches the upper STANAG limit. For enhanced measurements, optional vacuum/pressure ampoules enable the collection of both heat flow and pressure data.

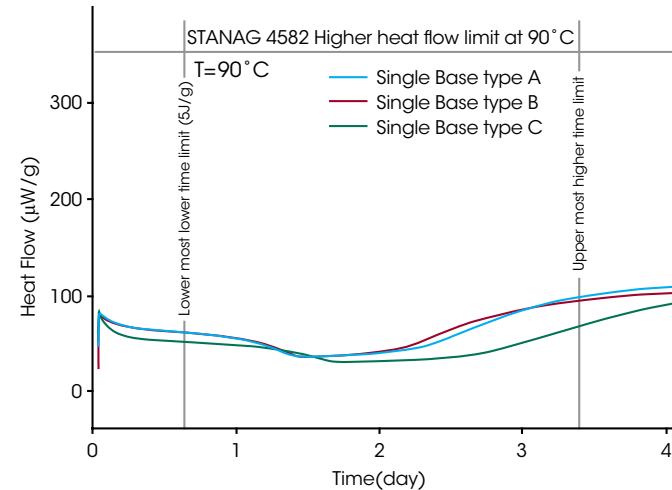

Stability of Sodium Percarbonate

Sodium percarbonate is manufactured in vast quantities around the world and is a major ingredient in laundry and automatic dishwasher detergents. One of the characteristics of sodium percarbonate is its thermal instability that causes it to undergo continuous degradation. The degradation of percarbonate is accelerated by water. It is common to coat the surfaces of the percarbonate particles to increase the stability by protecting them from humidity during storage and shipping. The figure shows the results of calorimetric stability tests on duplicate samples of coated and uncoated percarbonate particles using TAM at 30 °C and humid conditions. This data demonstrates the relative stability of the samples based on the magnitude of the exothermic heat flow. It also demonstrates the repeatability and the excellent long term stability of TAM. Production, storage and shipping environments can be adjusted to ensure the material remains as stable as possible. The gaps in the data are when samples were removed from the thermostat and stored in a heater block at 30 °C. When the samples were placed back in the thermostat, the signal was measured again and restored to the expected level.

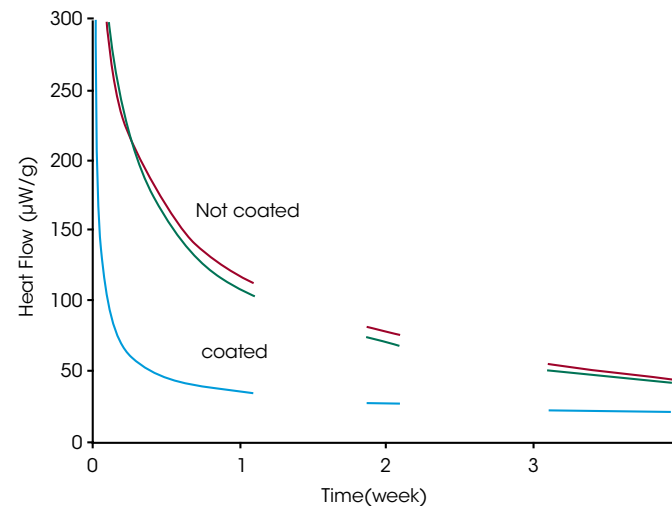

Material Compatibility

Compatibility testing is a form of stability testing that evaluates the possible interaction between the constituents of a multi-component sample. Microcalorimetry has proven to be particularly useful for compatibility testing; in some cases data is obtained after only a few hours. One example is the non-compatibility between wax and wool. The difference between the measured response and the expected response indicates incompatibility. This type of measurement is broadly applicable for safety screening, is simple to perform, and provides data that can be used for long term storage predictions under many conditions. For ammunition safety it is particularly important that the propellant has no unpredictable interaction with the other non-propellant components. STANAG 4147 cites microcalorimetry as one of the preferred methods to detect such incompatibilities.

Laundry Product Compatibility

Sodium percarbonate, SPC, is used as an oxidizing bleaching agent in many applications, e.g. laundry and automatic dishwasher detergents. Detergents usually include a variety of ingredients such as tensides, enzymes and perfumes. In order to increase the efficiency of tensides, inorganic absorbers such as Zeolite are commonly added to trap $\text{Ca}^{2+}/\text{Mg}^{2+}$ in the washing water. However, Zeolite can also trap $\text{Fe}^{2+}/\text{Fe}^{3+}$ and H_2O and both of these are known to reduce the stability of SPC. These tests were performed at 30 °C and with an RH of 70%. The data confirmed that there was an initial reaction when the peroxide and Zeolite were added together that had an initial rapid rate followed by a slowing and then a second slowly accelerating reaction. A major advantage of using microcalorimetry for stability testing is that the same sample is used during the entire measurement and is monitored continuously from start of reaction throughout the test. Another advantage is the multi sample stability testing - up to 48 samples can be studied in parallel. The excellent long-term stability of the calorimeter makes it possible to perform measurements for extended periods, e.g. weeks, although the incompatibility of peroxide and Zeolite could be predicted after only a few days.

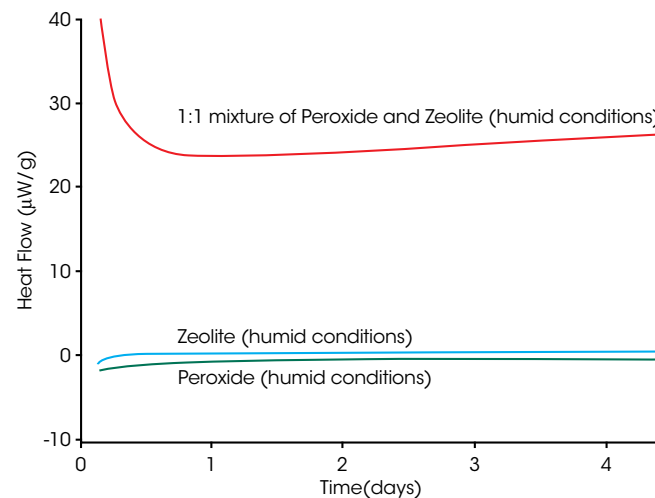
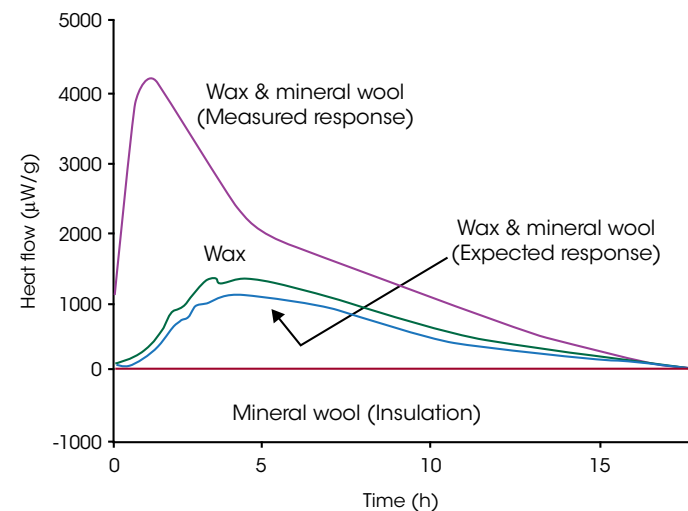

Stability of propellant (gun powder) under controlled humidity

Chemical stability is strongly influenced by storage conditions. After temperature, the most important atmospheric conditions for the stability of propellants is humidity. The RH Perfusion Ampoule allows for the atmospheric relative humidity to be controlled and even varied during the course of a heat flow measurement for propellant stability investigations. This control may be used to investigate or simulate storage and shipping conditions. The accompanying plot shows the heat flow from a gun powder sample held isothermally at 37°C and exposed to varying levels of atmospheric humidity. The measured heat flow increased with increasing RH. This higher heat flow at the higher humidity levels reflects lower stability, underscoring the importance of controlled, dry storage conditions.

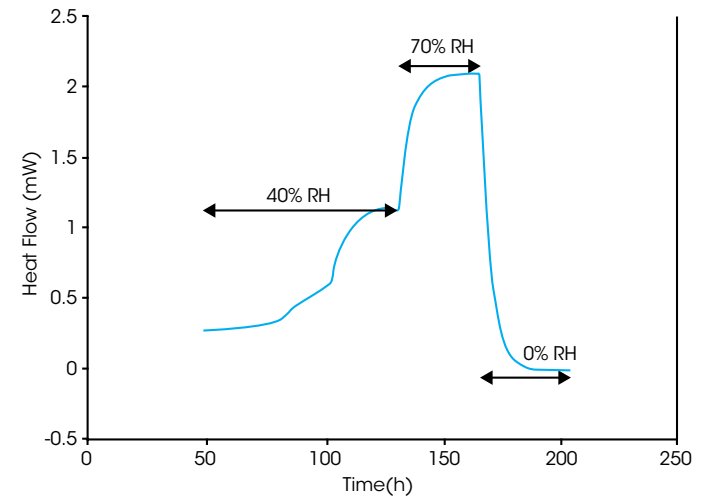

Efficiency of stabilizers

Polymers are sensitive to oxygen, however adding small amounts of antioxidants, e.g. radical scavengers and/or hydroperoxide decomposers, can prevent the unwanted oxidation reactions. The oxidation of unstabilised polyamide 6 film (40µm) stabilised with different amounts of a radical scavenger (Irganox 1098) was studied in air at 120°C. Increasing the ppm of the scavenger from 100 to 400 ppm shows a corresponding decrease in heat flow. The decrease in heat flow is a reflection of an increasing polyamide stability due to the reduction of oxidation. Isothermal microcalorimetry can be used not only to measure oxidation processes, but also to measure the efficiency of different stabilisers, as well as optimising the amount of stabiliser used in formulating a stable polymer.

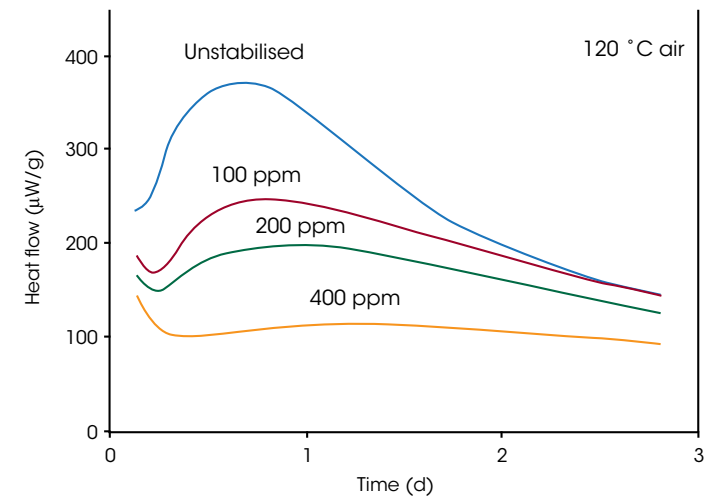

Battery charge-discharge cycling

Both charging and discharging processes for batteries involve an exchange of heat with the surroundings. For rechargeable batteries, it is especially important to monitor the open- and closed-circuit discharge processes immediately after charging. For these measurements the battery can be connected directly to a circuit for in situ measurements. The accompanying plot includes data for three cycles of charging, reflected as highly energetic exothermic peaks. The slow self-discharge process immediately afterward was measured to evaluate the charge stability. The TAM IV has the sensitivity and stability to measure the low-energy self-discharge event, the dynamic thermal range to measure the energetic charging process, and the flexibility to accommodate the more sophisticated circuit load measurements.

Battery open circuit discharge

The static self-discharge of a battery is a slow event that reflects the ability of the battery to hold a stable charge under storage conditions. Isothermal microcalorimetry is a non-destructive method for measuring this process accurately and reproducibly. A large heat flow from the battery under static conditions typically reflects poor stability and most often predicts a short shelf life. In the accompanying figure the static heat flow is shown for a Lithium-ion 18650 battery compared to a blank control measurement. The measured heat flow is proportional to the rate of self discharge.

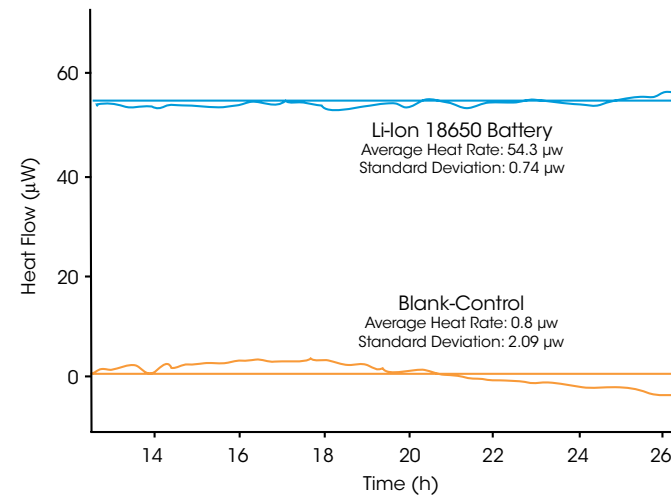
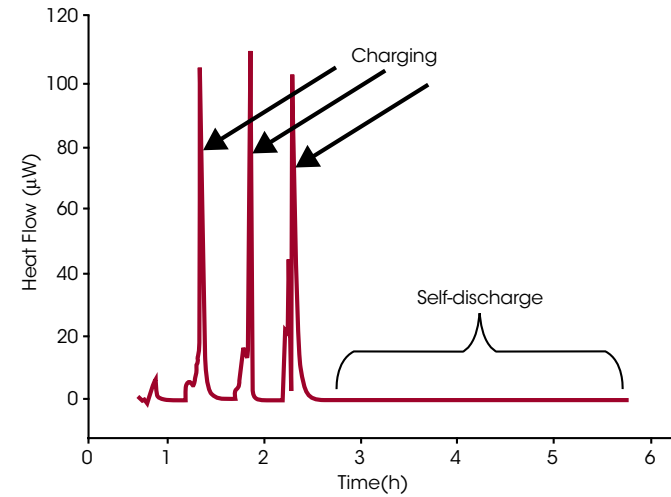

Thermoplastic Polymer Rheology Using Parallel Plate

Parallel Plate geometries are most popular for testing of thermoplastic polymer melts. An example of polystyrene characterized over a temperature range of 160 °C to 220 °C is shown in the figure to the right. Frequency sweeps were run at multiple temperatures over an experimental range of 0.06 to 628 rad/s. The magnitude of the viscoelastic properties, storage modulus (G') and loss modulus (G''), for the individual sweeps can be seen to decrease with increasing temperature over this frequency range. Since polymer melts are viscoelastic, their mechanical response will be time-dependent, so low frequency corresponds to long-time behavior. Time Temperature Superposition (TTS) is used to widen the range of data to higher and lower frequencies and generate a Master curve at a reference temperature pertinent to the application. The polymer's molecular structure dictates the magnitude and shape of the G' and G'' curves.

Polystyrene Frequency Sweeps from 160 °C to 220 °C

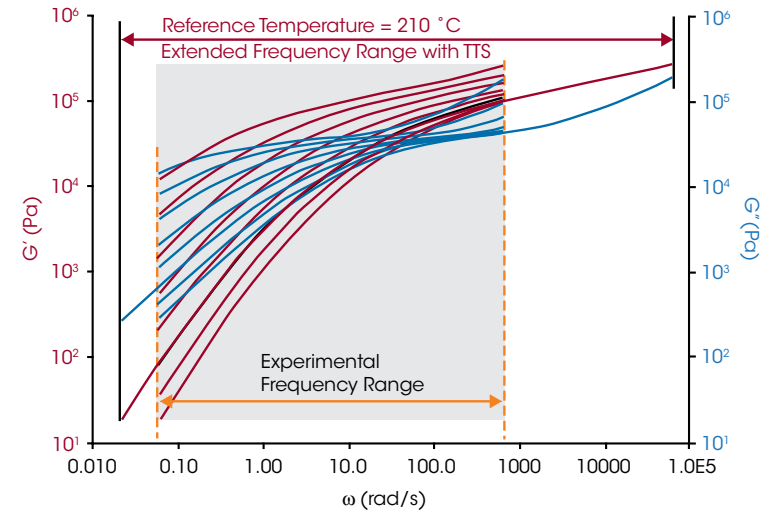

Thermoset Cure Using Disposable Plate Kit

Changes in the viscoelastic properties of reactive systems provide valuable information about their processing and end-use properties. Often these materials can start in the form of a low viscosity liquid, a paste, or even a powder, and after reacting end as a high modulus solid. If the material hardens and adheres to the testing surface, low-cost disposable parallel plates are required for testing.

The figure to the right shows the complex viscosity from a typical oscillatory temperature ramp and hold curing test conducted on a B-stage prepreg using 25 mm diameter disposable plates. The resin is impregnated on a woven glass matrix, which becomes part of the permanent high strength composite structure once the resin is cured. Upon heating, the resin softens until reaching a minimum viscosity, which is a very important processing parameter. If the viscosity is too high or too low, the resin will not flow or coat the matrix uniformly leaving voids, creating flaws in the composite. Eventually the viscosity starts building and the curing reaction takes off dramatically. The temperature is held constant at the processing temperature and the viscosity is monitored until the viscosity reaches a plateau indicating the completion of the reaction.

B-Stage Prepreg Temperature Ramp and Hold Cure

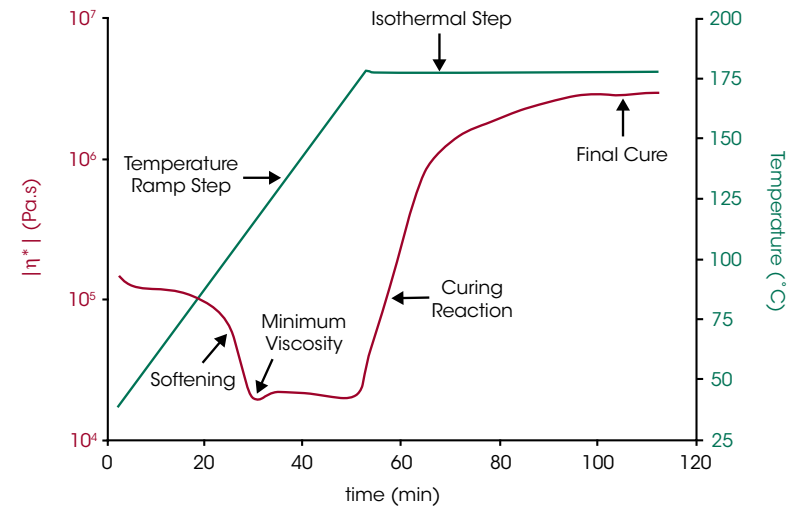

Solid Polymer Rheology Using Torsion Rectangular Clamps

The ETC oven has the ability to characterize the viscoelastic properties of rectangular solid samples up to 5 mm thick, 13 mm wide, and 50 mm long. The figure to the right shows an example of an oscillatory temperature scan on a solid ABS specimen run at 3 °C/min from -160 °C to 200 °C. The ABS is a copolymer that exhibits two glass transition temperatures: one at -81 °C associated with the Butadiene and one at 114 °C associated with Styrene. Transitions, or relaxations of molecular segments, are observed as step changes in the storage modulus (G') and as peaks in the loss modulus (G'') and damping ($\tan(\delta)$). The magnitude and shape of these parameters will depend on chemical composition as well as physical characteristics such as crystallinity, orientation, fillers, and degree of cross-linking.

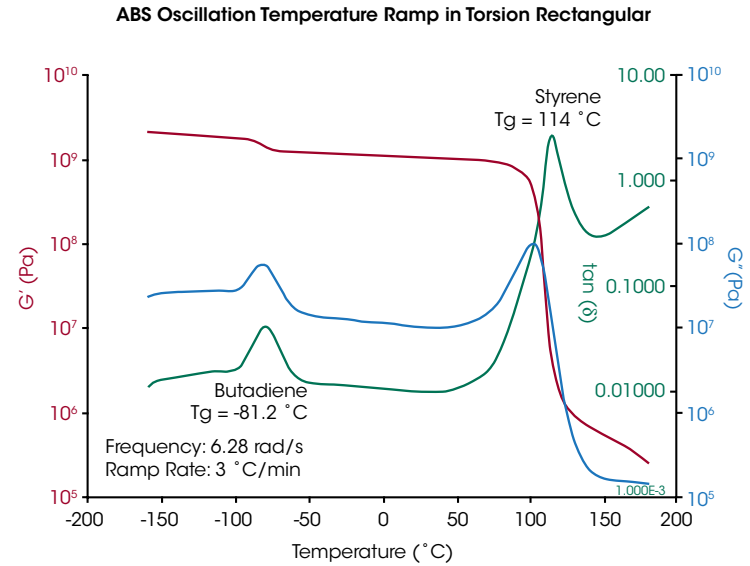

Extensional Viscosity measurements with the SER3 Attachment

The ETC is designed to accommodate the EVA (Extensional Viscosity Accessory) and SER3 (Sentmanat Extension Rheometer) for extensional viscosity measurements of materials like polymer melts. In the figure to the right, data are plotted for extensional viscosity measurements of standard LDPE 1810H at 150 °C at extensional rates from 0.02 to 3 s⁻¹ using the SER3. These results are compared to three times the corresponding low shear rate viscosity, which agrees well with the zero rate extensional viscosity prior to the onset of extensional thickening at different extension rates. In addition to extensional viscosity, the SER3 can also be used for solids tensile testing, tear testing, peel testing, as well as high-rate fracture testing.

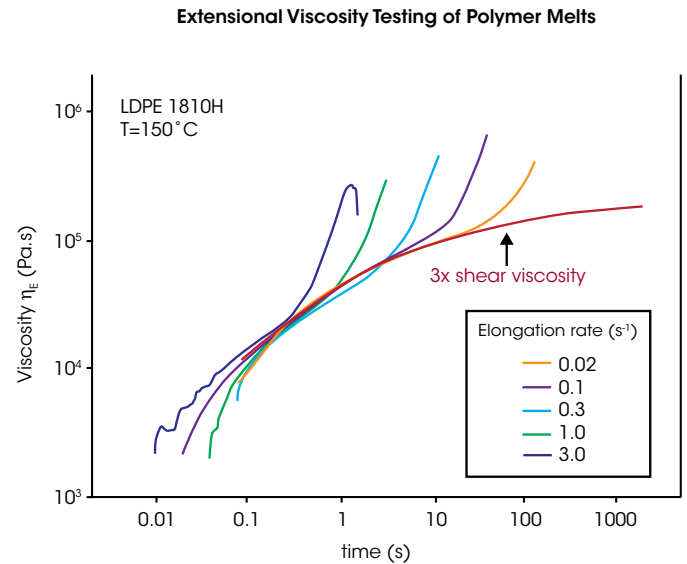

Isothermal microcalorimetry in biological science has proven to be particularly useful for research characterizing the metabolic activities of living systems and in studies of cellular and biomolecular interactions. Microcalorimetry has the advantage of being general, nondestructive and very sensitive, thus enabling metabolic activities to be monitored, in real time and under a wide variety of conditions, on samples such as intact tissue biopsies or cell cultures and small animals, insects or plants.

Isothermal Titration Calorimetry

Isothermal Titration Calorimetry (ITC) can be used to study molecular interactions and binding reactions in the pharmaceutical and life sciences fields. This example shows the binding of Insulin Growth Factor I (IGF-I) to its receptor (IGF-1R). It is possible to calculate the thermodynamic properties of the binding and the results helped characterize the biological response of this binding event. Detailed analysis of the ITC binding data for IGF-1 to IGF1R not only characterized the thermodynamics of the binding event, but clearly demonstrated a molecular conformational change occurring as a result of this interaction.

Fermentation

Isothermal microcalorimetry is a powerful tool in the study of microbial food spoilage. However, microorganisms not only spoil food, they can also be used to preserve it. There are many examples of foods which are made with the help of microorganisms, e.g.: beer, wine, pickled cucumbers, kimchi and some types of sausages. Also, there are fermented milk products, such as yogurt and the soft cheeses, such as brie or camembert. Since all microbiological metabolism produces heat, isothermal microcalorimetry is a fast, easy and convenient method to study these processes.

The figure shows the heat produced during milk fermentation when different additives are included. The simultaneous direct measurements made on these samples revealed the effectiveness of each additive to either delay and/or reduce the heat flow from the samples over time and allowed the quick ranking of each additive as to its effectiveness in inhibiting the fermentation process.

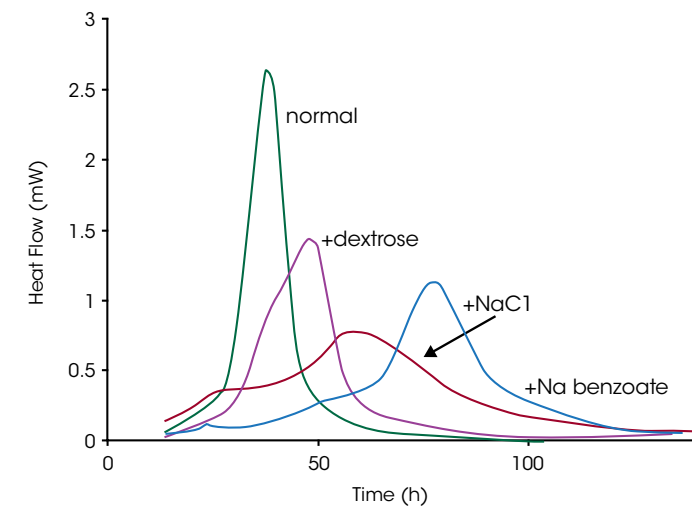
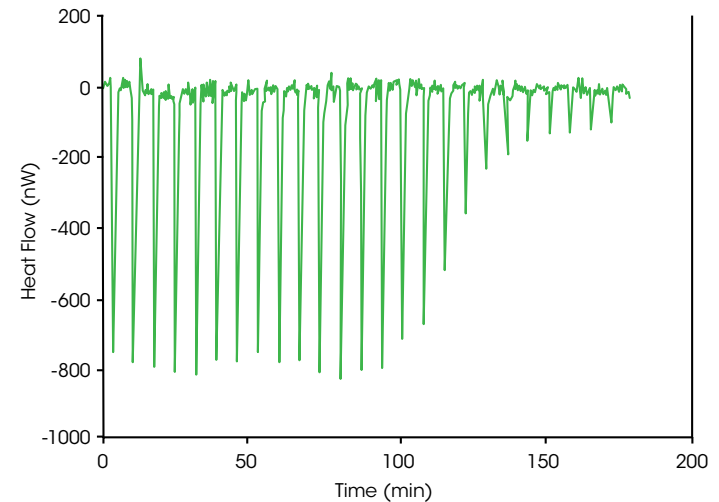

Microbial metabolism

The use of isothermal microcalorimetry in microbiology is a rapidly growing application. This technique has emerged as a very sensitive and rapid method for microorganism detection, possible identification and evaluation of antibiotic susceptibility and resistance. Quantitative studies have revealed that on average a single bacteria in an active growth phase will produce a heat flow of approximately 2 pW. Extrapolation of this number suggests that the detection limit in a sample is approximately 100,000 individual bacteria. A wide variety of microorganisms have been evaluated with isothermal microcalorimetry. The method is easy to set up and it rapidly detects even slow growing bacteria such as *Mycobacterium tuberculosis*. Three unique metabolic thermograms are shown (red, blue and yellow), each representative of a different species of bacteria.

Microorganism detection

Detection and identification of microorganisms in patient blood and donated platelet concentrates is essential in clinical practice to improve patient care and safety. Commercial blood culture systems are well established, trusted methods for detecting bacteria in samples such as blood and platelet concentrates. These techniques typically require a relatively large sample for testing and the time required for an assay result can be 24-48 hours. Calorimetric detection of microbial growth has been shown in frequent cases to be more sensitive, requires a smaller sample and gives reliable data in a shorter time (<10 hrs) than the typical blood culture. The data displayed shows the sensitivity of isothermal microcalorimetry in detecting *E. coli* that has been spiked into platelet solutions within several hours after starting the assay. Quickly detecting bacteria in platelet preparations is important in establishing maximum storage times for platelets and helping to reduce transfusion related infections.

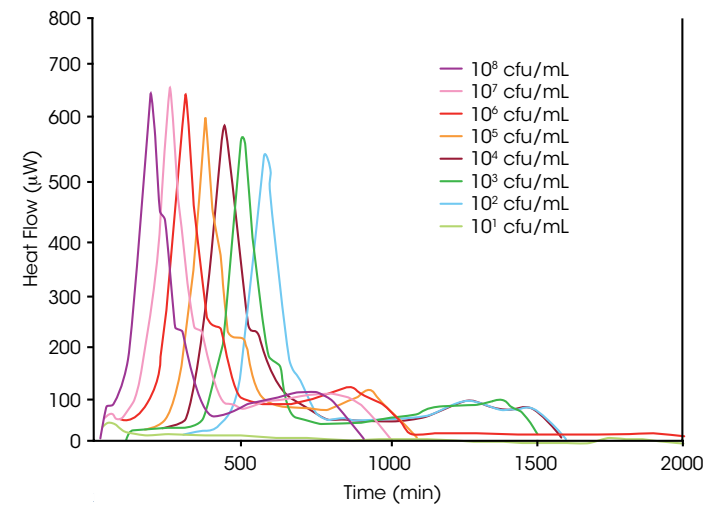
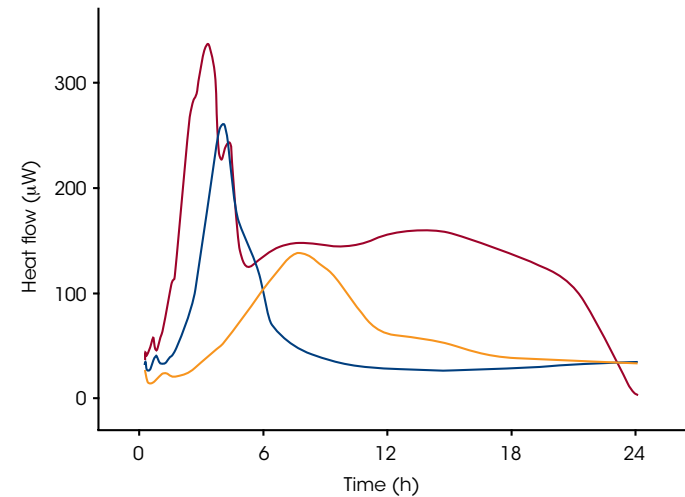

Apoptosis

It is well known that an energy burst precedes the metabolic event in growing cells known as programmed cell death (apoptosis). When an apoptotic triggering event happens in a viable cell, the metabolic machinery in the cell is mobilized to provide the energy required for processes such as the destabilization and fragmentation of the cellular DNA and cell death. Thus, a microcalorimetric thermogram is a valuable tool in distinguishing between apoptosis and necrosis, the latter being a reaction to a wide variety of cell trauma that usually results in cell death. The data shows that within 20 minutes of an addition of a monoclonal antibody, anti-BAL, a population of leukemia cells sensitive to the antibody displayed a metabolic energy burst (solid line) consistent with the cells entering into the apoptotic cascade toward cell death. The dashed line represents the metabolic activity of leukemia cells when buffer is substituted for the antibody. The actual cell death measured as fragmentation of DNA happened after 18 hours, data not shown.

Cell growth - hormone stimulation

The analysis of cell growth when assessing the binding properties and metabolic influence of newly developed drugs is a critical step in the drug development pathway. Prior to these cell growth assays, initial studies are typically carried out with cell free techniques such as ITC. However, after the cell free phase of testing is complete, the effects of the drug are tested on in vitro tissue biopsies or actively growing cell cultures. A wide variety of effects can be expected, including overall metabolic increase or decrease that have been known to cascade to extreme events such as apoptosis. Isothermal microcalorimetry is a highly sensitive technique that has been successfully used as a bioassay for even the smallest change in metabolic activity. The example uses mammalian cells as the target sample and a growth hormone (GH) is added to the cultures at varying concentrations. The upper graph shows the earliest metabolic response happening in less than 20 minutes. The heat production increase to various GH concentrations (shown numerical in the figure) can be used to construct dose-response curves. The power of isothermal microcalorimetry is that not only are the early metabolic events captured, but the effect of the growth hormone could be monitored for hours or even days on the same samples.

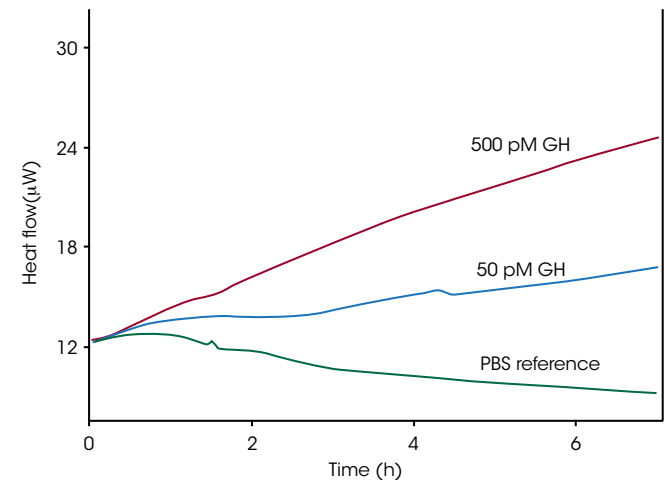
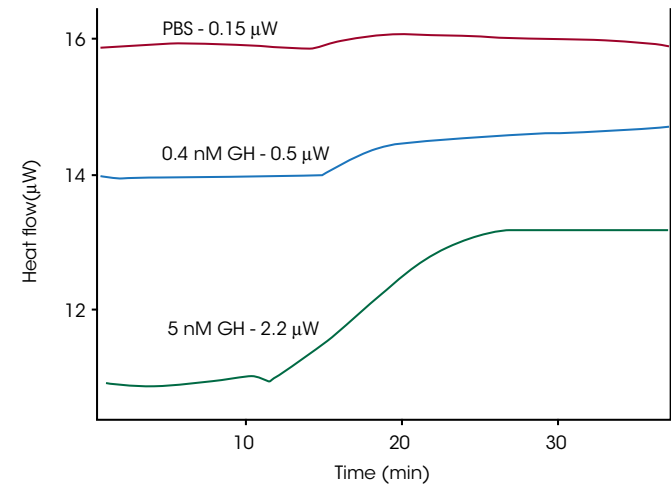
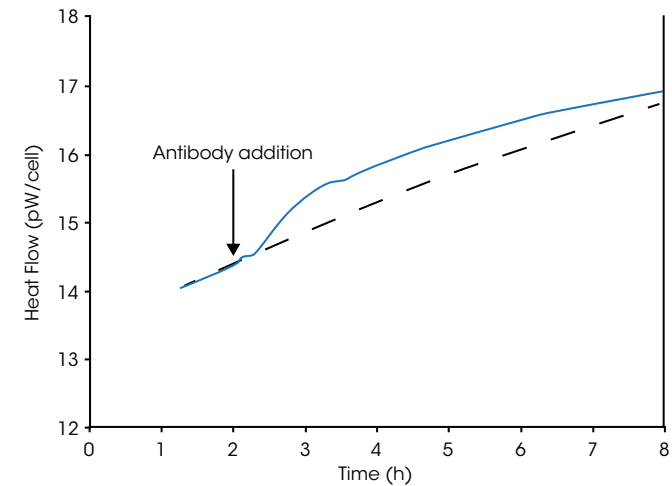

Cell growth - drug sensitivity

Assessment of cancer therapeutic drugs with a bioassay has always been an advanced assay that is a powerful tool in determining which drug would potentially be the best for clinical treatment of the disease. Isothermal microcalorimetry is a fast, easy method for making this assessment. With proper controls being tested simultaneously, isothermal microcalorimetry can detect very small changes in cellular metabolism upon the addition of any selected drug to the growth environment. In the example, methotrexate at a variety of concentrations was added to in vitro cultures of T-lymphoma tumor cells. The resulting metabolic thermograms could easily be converted into dose response curves. In most cases, a dose response determined with calorimetric measurements is faster (hours) and technically less demanding (no colony counts or enzyme assays to perform).

Biocompatibility

The interaction between biological tissues and artificial materials is becoming increasingly important in the field of bioengineering. One very important medical application where biocompatibility is critical is blood dialysis. Any incompatibilities between hemodialysis membranes and human blood would be very detrimental to this life saving clinical procedure. One example where isothermal microcalorimetry has been used as an assay to test biocompatibility is in the detection and characterization of the interactions of human granulocytes and a variety of polymer materials that would come in contact with blood cells in a typical dialysis machine. Granulocytes are characterized by a low basal metabolism combined with a large metabolic burst associated with phagocytosis when exposed to foreign particles. In this example Granulocytes are added to different membranes and heat flow is measured. After two hours Zymosan particles are added to induce phagocytosis in the granulocytes.

It is demonstrated that the granulocytes exhibits this metabolic burst behavior when exposed to the inert material fluorinated ethylene propylene (FEP) however when exposed to regenerated cellulose (Cu) the metabolic burst was much smaller. This type of direct comparison is important when ranking various polymeric materials for potential uses that involve contact with blood cells.

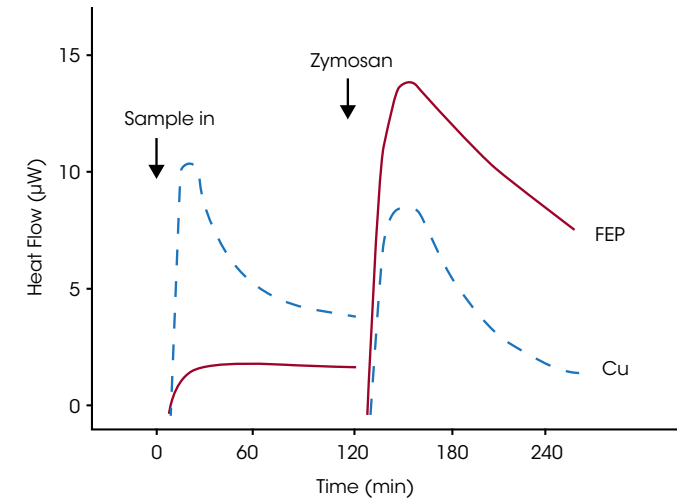
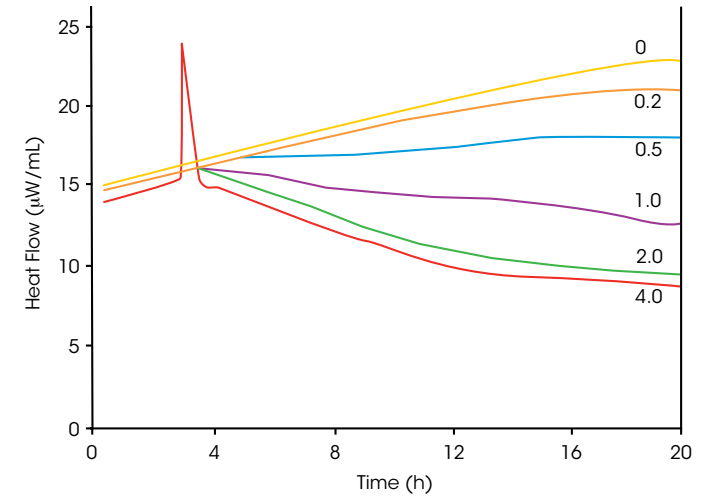

TAM IV & 48 | SPECIFICATIONS

TAM IV

Thermostat specifications

Thermal Media	Oil
Calorimeter Positions	4
Temperature Range	4 °C to 150 °C
Accuracy	< ± 0.1 °C
Long Term Stability	< ± 100 µ°C/24h
Scanning Rate	≤ ± 2 °C/h

Calorimeter specifications*

CALORIMETER	SHORT TERM NOISE	BASELINE DRIFT	ACCURACY	PRECISION
Nanocalorimeter	< ± 10 nW	< 40 nW/24 h	< 2%	± 100 nW
4 mL Minicalorimeter / Multi	< ± 100 nW	< 200 nW/24 h	< 5%	± 200 nW
Microcalorimeter 20mL	< ± 100 nW	< 200 nW/24 h	< 2%	± 100 nW
20 mL Minicalorimeter/Multi	< ± 300 nW	< 1 µW/ 24 h	< 5%	± 300 nW
Macrocalorimeter	< ± 500 nW	< 6 µW /24h	< 5%	± 3 µW
DETECTABILITY				
Solution Calorimeter**	< ± 10 µ°C	1-4 mJ	< 0.2%	Q > 100 J:0.02%
				Q < 50 J:<±10 mJ
				Q < 0.1 J:<± 5 mJ

*Isothermal Operation

**Temperature Range 15 °C - 90 °C

TAM IV-48

Thermostat specifications

Thermal Media	Oil
Calorimeter Positions	48
Temperature Range	4 °C to 150 °C
Accuracy	< ± 0.1 °C
Long Term Stability	< ± 100 µ °C/24h
Scanning Rate	≤ ± 2 °C/h

Calorimeter specifications*

CALORIMETER	SHORT TERM NOISE	BASELINE DRIFT	ACCURACY	PRECISION
4 mL Minicalorimeter	< ± 100 nW	< 200 nW/24 h	< 5%	± 200 nW

*Isothermal Operation

Specifications

Microreaction system	1mL		4mL		20mL	
	Baseline drift $\mu\text{W}/24$ hours	Short term noise μW	Baseline drift $\mu\text{W}/24$ hours	Short term noise μW	Baseline drift $\mu\text{W}/24$ hours	Short term noise μW
Titration (with titration reference)	<0.06	< ± 0.02	<0.08	<0.05	<0.4	< ± 1
Liquid Perfusion	<0.8	< ± 0.05	<0.8	<0.05	<1	< ± 1
Gas Perfusion	<2	< ± 1	<2	< ± 1	<2	< ± 1
RH Perfusion	<2	< ± 1	<2	< ± 1	<2	< ± 1
Micro Solution					<1	± 0.1
Vacuum Pressure			<0.05	< ± 0.2	<1	< ± 0.5

*Specifications are based on a balanced calorimeter setup and non-corrected heat flow data

References

- L.E. Briggner "Microcalorimetric characterization of physical changes in solid state drugs" Thermometric AN 22022
- T. Otsuka, S. Yoshioka, Y. Aso and T. Terao, Chem. Pharm. Bull. 42(1) 1994
- Phipps, M.A.; Mackin, L.A. Pharm. Sci. Tech. Today, 3(1), 9-17 (2000)
- Selzer, Radau & Kreuter, Int. J. Pharm., 171, 227-241, (1998).
- Forsström, D., Thesis, "Novel techniques for characterisation of the oxidative stability of polyamides", KTH (1999)
- Schmitt, Peck, Sun & Geoffroy, Thermochim. Acta, 380, 175-184, (2001).
- K. Bystrom "Microcalorimetric testing of physical stability of drugs in the solid state" Thermometric AN 22004
Data provided by L.E. Briggner, AstraZeneca, Sweden (2002)
- Hogan, S.E. & G. Buckton. Int. J. Pharm., 207, 57-64. The quantification of small degrees of disorder in lactose using solution calorimetry. (2000)
- Hongisto, Lehto & Laine, Thermochim. Acta, 276, 229-242, (1996).
Data provided by Svensson, Bodycote Materials AB, Sweden (2003)
- C. Petersson, P. Pekonen, D. Forsström "The long-term stability of sodium percarbonate in presence of Zeolite" Thermometric AN 22040
- D. Forsström "Efficiency of stabilisers in polymers measured by microcalorimetry" Thermometric AN 22027
- D. Hallén "The role of titration microcalorimetry in the drug design process" Thermometric AN 22024
"Milk Fermentation studied by Isothermal Calorimetry" Themometric AN 314-04
- Andrej Trampuz, Simone Salzmann, Jeanne Antheaume, Reno Frei, A.U. Daniels "Microcalorimetry - A Novel Method for Detection of Microorganisms in Platelet Concentrates and Blood Cultures" University of Basel & University Hospital Basel, Switzerland (2006)
- A. Schön "The use of TAM for the early detection of programmed cell death" Thermometric AN 22029
- A. Schön "The effect of human growth hormone on cells" Thermometric AN 22032
- Bermudez, J., Bäckman, P. and A. Schön "Microcalorimetric Evaluation of the Effects of Methotrexate and 6-Thioguanine on Sensitive T-Lymphoma Cells and on a Methotrexate-Resistant Subline" (1992). Cell. Biophys. 20, 111-123.
- L. Ljunggren & A. Schön "Biocompatibility of dialysis membranes" Thermometric AN 22030



- AMERICAS**
- New Castle, DE USA
- Lindon, UT USA
- Eden Prairie, MN USA
- Chicago, IL USA
- Costa Mesa, CA USA
- Montreal, Canada
- Toronto, Canada
- Mexico City, Mexico
- São Paulo, Brazil

- EUROPE**
- Hüllhorst, Germany
- Eschborn, Germany
- Wetzlar, Germany
- Elstree, United Kingdom
- Brussels, Belgium
- Etten-Leur, Netherlands
- Paris, France
- Barcelona, Spain
- Milano, Italy
- Warsaw, Poland
- Prague, Czech Republic
- Solna, Sweden
- Copenhagen, Denmark

- ASIA & AUSTRALIA**
- Shanghai, China
- Beijing, China
- Tokyo, Japan
- Seoul, South Korea
- Taipei, Taiwan
- Guangzhou, China
- Petaling Jaya, Malaysia
- Singapore
- Bangalore, India
- Sydney, Australia



©2022 TA Instruments/Waters Corporation. Printed in the U.S.A. August 2022 L50031.001

TA Instruments

159 Lukens Drive
New Castle, DE 19720 U.S.A.
T: 1 302 427 4000
F: 1 302 427 4041
www.tainstruments.com

Waters Corporation

34 Maple Street
Milford, MA 01757 U.S.A.
T: 1 508 478 2000
F: 1 508 872 1990
www.waters.com