

Flyer

Kardex VCM Box

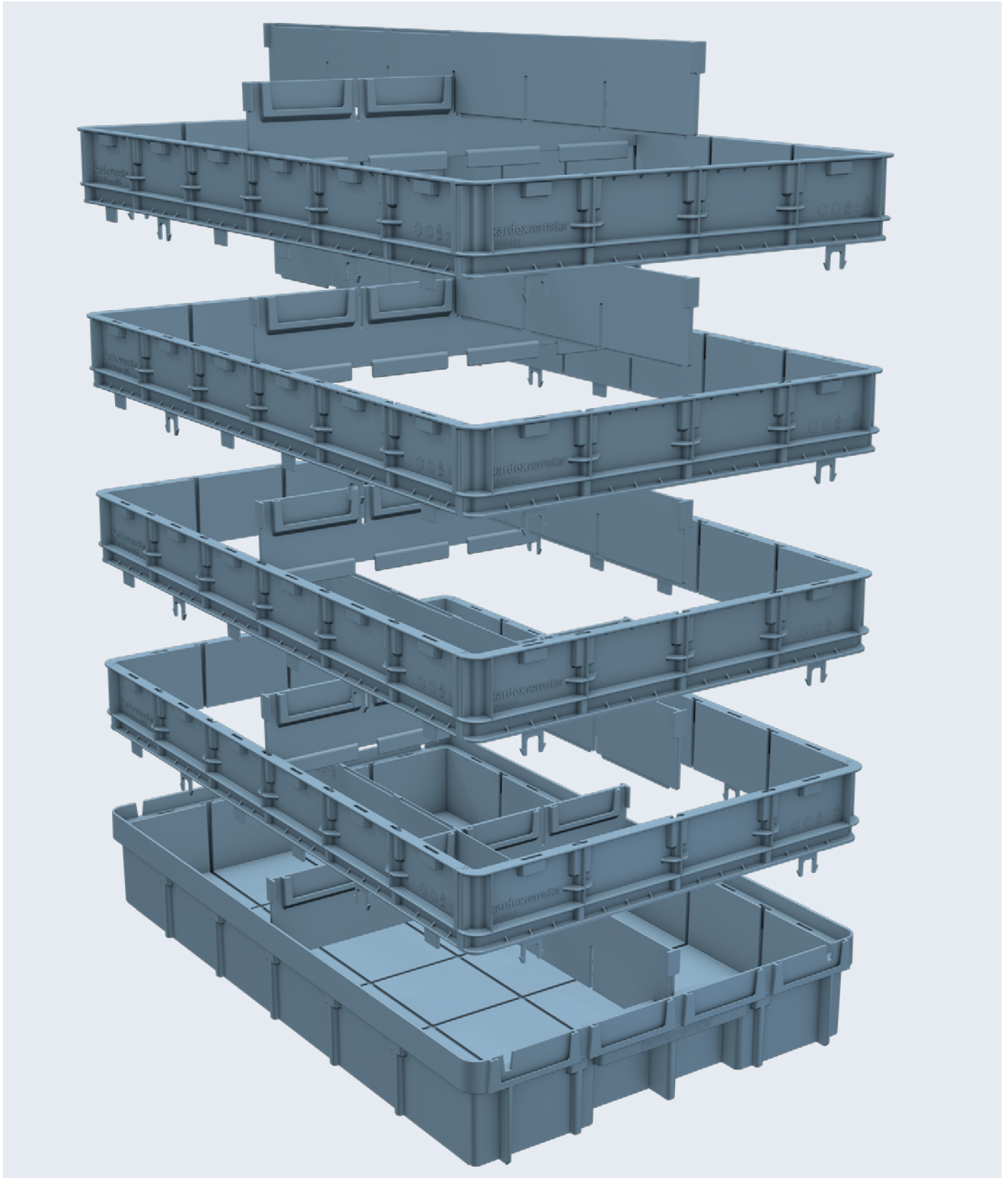

Kardex VCM Box Base

The base is the most important component, as all other frames and dividers are based up on it.

The Kardex VCM Box, tailor-made for the Vertical Carousel Module (VCM), ensures a flexible, customized, and organized storage solution. It is available either with a width of 200 mm or 400 mm, each with a depth of 425 mm, 525 mm or 625 mm. The base can be adjusted with different frames and dividers to create individual storage locations for various items. Fixed label holders are already integrated in the front area.

With an ergonomically shaped handle and a slight elevation in the longitudinal direction at the bottom of the box, the Kardex VCM Box can quickly and comfortably pull out of the carrier and push back in smoothly. The two bars in the front area of the box are specifically there to utilize the full depth of the carrier. The bars prevent the box from slipping over the carrier. Thanks to a slight incline in the lower area of these bars, it is also possible to pull the box ergonomically and easily over the front lip of the carrier.

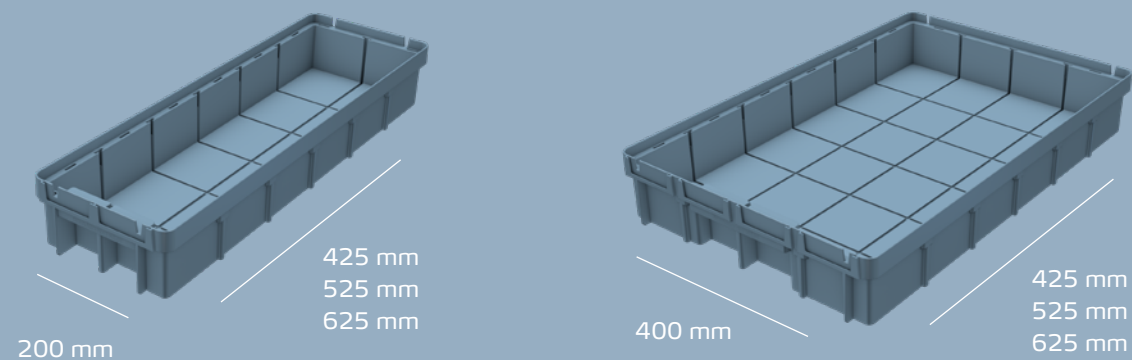

Unique frame system

The Kardex VCM Box is recognized by its frame concept. The unique and innovative Kardex EasyClick system allows for building the Kardex VCM Box base to different heights and continuously adapts to maximize the box volume.

The Kardex VCM Box is a highly flexible option that will adapt to your future needs since it is possible to change its height by adding or reducing frames.

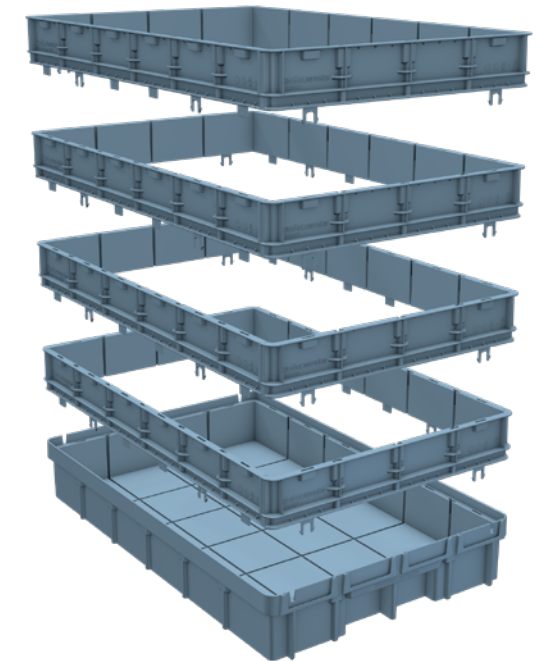

Flexible
and scalable
box system

Optimally
adapts to the
customer's
needs

Effective
use of available
storage space

Flexible divider system

The Kardex VCM Boxes flexibly divide and quickly adapt at any time by using cross and longitudinal dividers. The individual divider concept creates different combinations in order to reach the desired height.

This creates individual storage locations, enhances the flexibility as well as scalability of the box to deliver a complete storage and classification system, and further ensures maximum storage volume and high-density storage.



Smart plug-in with EasyClick system



Environmentally friendly

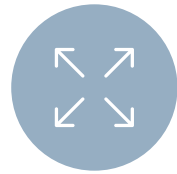

Highly-flexible height, width, and depth

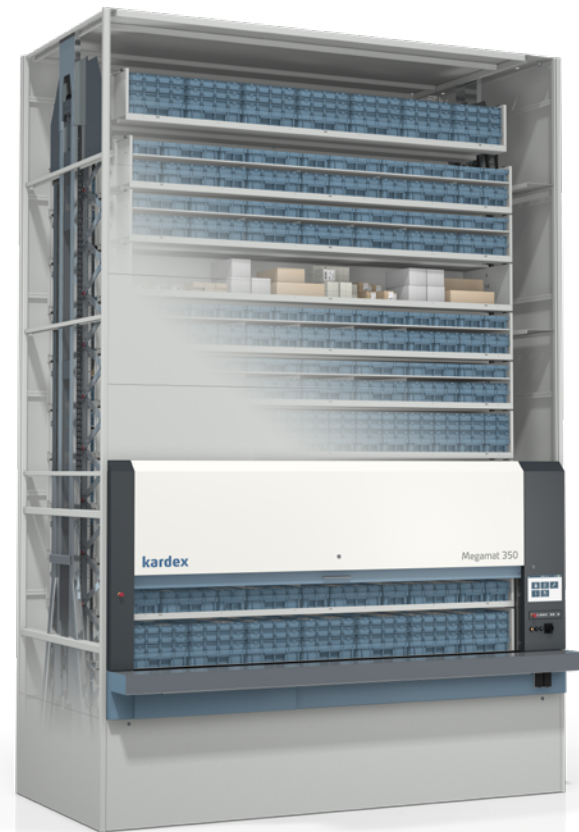

Technical data

Kardex VCM Box

Dimensions	VCM Box 4-2-1 Outside 425 × 200 × 95 mm Inside 398 (382) × 175 × 87 mm	VCM Box 4-4-1 Outside 425 × 400 × 95 mm Inside 398 (382) × 375 × 87 mm
	VCM Box 5-2-1 Outside 525 × 200 × 95 mm Inside 498 (482) × 175 × 87 mm	VCM Box 5-4-1 Outside 525 × 400 × 95 mm Inside 498 (482) × 375 × 87 mm
	VCM Box 6-2-1 Outside 625 × 200 × 95 mm Inside 598 (582) × 175 × 87 mm	VCM Box 6-4-1 Outside 625 × 400 × 95 mm Inside 598 (582) × 375 × 87 mm
Weight (empty box)	VCM Box 4-2-1 550 g	VCM Box 4-4-1 940 g
	VCM Box 5-2-1 660 g	VCM Box 5-4-1 1100 g
	VCM Box 6-2-1 788 g	VCM Box 6-4-1 1250 g
Volume	VCM Box 4-2-1 6,08 l	VCM Box 4-4-1 13,03 l
	VCM Box 5-2-1 7,61 l	VCM Box 5-4-1 16,31 l
	VCM Box 6-2-1 9,14 l	VCM Box 6-4-1 19,59 l
Elevation grid of the frames	95 mm (1 base)	340 mm (1 base + 4 frames)
	145 mm (1 base + 1 frame)	405 mm (1 base + 5 frames)
	210 mm (1 base + 2 frames)	470 mm (1 base + 6 frames)
	275 mm (1 base + 3 frames)	
Elevation grid of the dividers	95 mm (1 divider 95 mm)	340 mm (1 divider 145 mm + 3 dividers 65 mm)
	145 mm (1 divider 145 mm)	405 mm (1 divider 145 mm + 4 dividers 65 mm)
	210 mm (1 divider 145 mm + 1 divider 65 mm)	470 mm (1 divider 145 mm + 5 dividers 65 mm)
	275 mm (1 divider 145 mm + 2 dividers 65 mm)	
Material	Polypropylen (PP)	
Colour	Silver fir blue 230/60/15	
Payload	Up to 35 kg	

7 examples of more than 100 flexible segment layouts

Box with 400 mm width and 625 mm depth

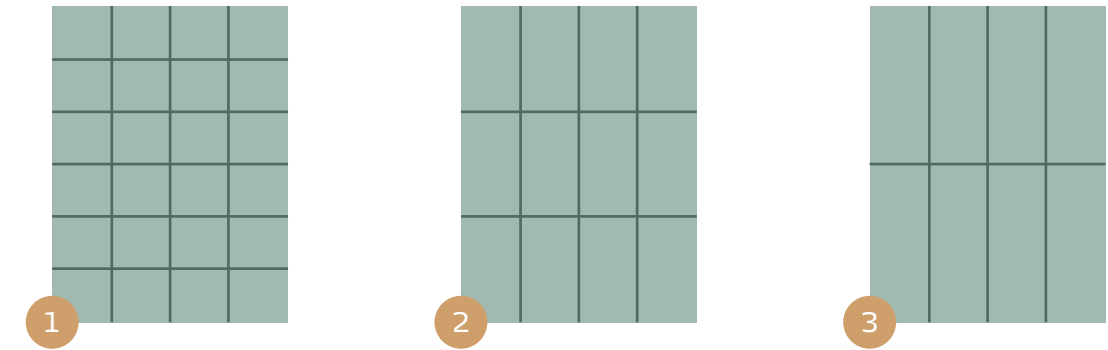

Box with 200 mm width and 625 mm depth

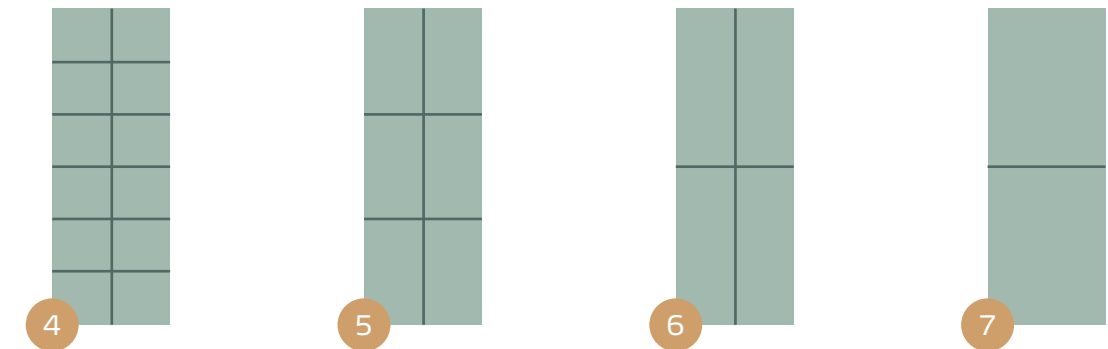

Design	Number of locations	Inner size dimensions in mm × Y*
1	24	24 × (94 × 99)
2	12	12 × (94 × 199)
3	8	8 × (94 × 298)
4	12	12 × (87 × 99)
5	6	6 × (87 × 199)
6	4	4 × (87 × 298)
7	2	2 × (174 × 298)

* Y = flexible height 95/145/210/275/340/405/470 mm

Also available
as ESD-
Version

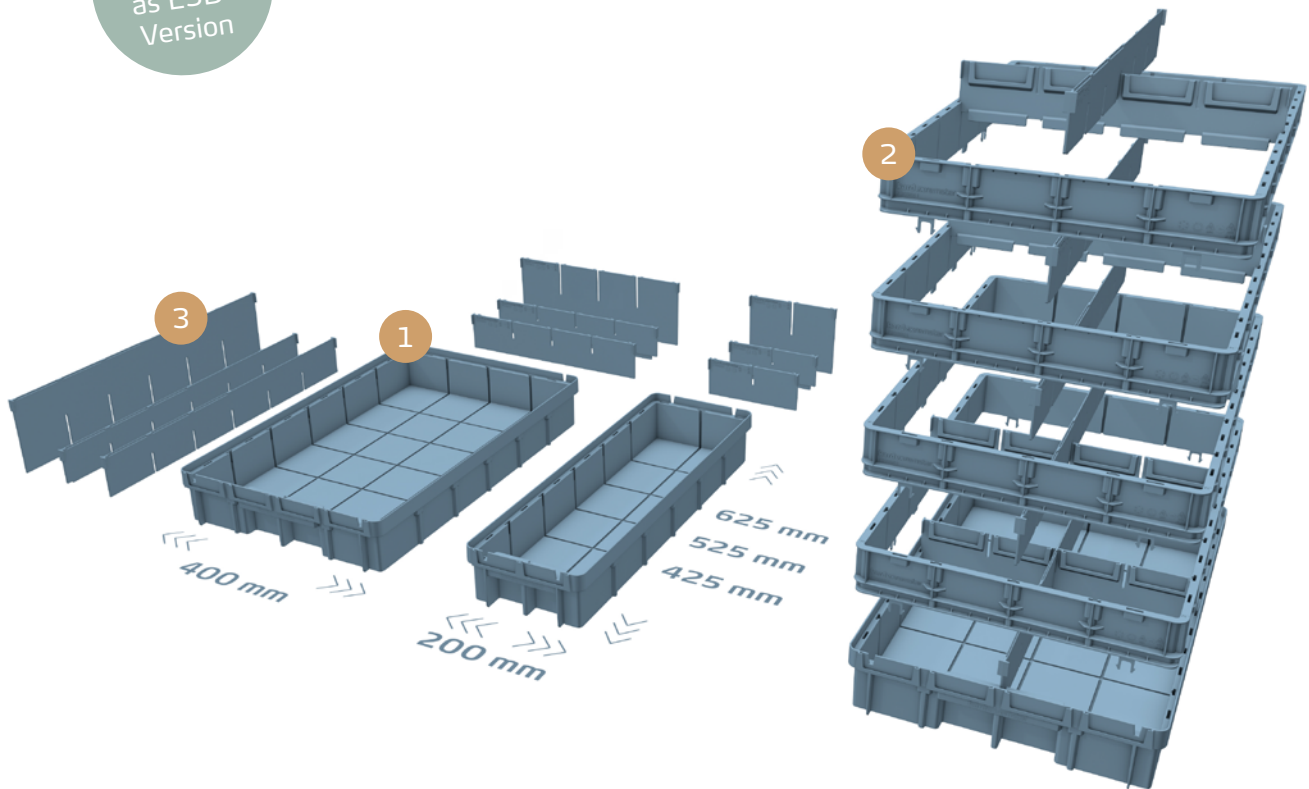

1 Base

The base is the most important unit in the Kardex VCM Box concept, as all other frames and dividers are based up on it.

2 Frame

With an EasyClick system, the frames can be placed on the base and plugged into each other to adjust the height of the box quickly and flexibly.

3 Divider

This concept further increases the flexibility of the box to provide a comprehensive storage and classification system for the Vertical Carousel Module.

 Contact us