

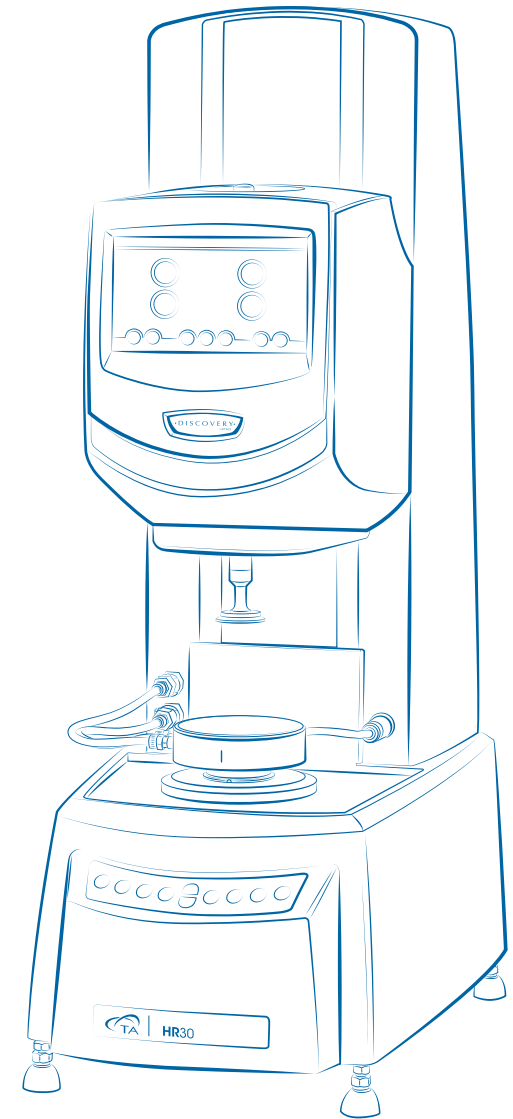

DISCOVERY HYBRID RHEOMETER

**Discover the
rheometer
with the
Sensitivity
Ease-of-use
Versatility**

to address the most
demanding applications



HR 30/20/10 | DISCOVERY HYBRID RHEOMETER

TA Instruments invites you to experience the latest innovations in rotational shear rheometers, the Discovery Hybrid Rheometer HR 10, HR 20, and HR 30. The Discovery Hybrid Rheometers are designed for scientists who need to obtain better rheological data, under the widest range of measurement conditions, collected by more users, with less training.

Advances in core measurement technology enable **more sensitive measurements with superior precision**. This empowers you to measure lower viscosities and weaker liquid and soft-solid structure, while consuming less material. Superior dynamic performance gives a higher level of accuracy in measurements of G' and G'' so you can make decisions quickly, with confidence.

Thoughtful hardware and software design results in a complete system that **simplifies every user interaction**. Routine functions are faster and more intuitive, so you can accomplish more with less training.

The performance of the Discovery Hybrid Rheometer is supported by the **widest range of powerful, easy-to-use environmental systems and accessories** that allow you to replicate demanding environmental conditions, incorporate complementary simultaneous measurements, or extend your rheometer beyond conventional shear rheology.

Discover the advanced engineering and attention to detail that provides enhancements in every aspect of rheometer technology and user experience. From the most cost-effective rheometer with industry-leading performance to the most advanced rheometer available, there is a Discovery Hybrid Rheometer to meet your needs and exceed your expectations.

The **DISCOVERY HYBRID RHEOMETER** The **MOST POWERFUL** and **VERSATILE RHEOMETER** for your laboratory



DISCOVER UNPARALLELED MEASUREMENT SENSITIVITY and ACCURACY

Measure the lowest stresses and smallest sample volumes with revolutionary torque sensitivity

Unrivaled low torque sensitivity empowers you to measure lower viscosities and weaker intermolecular structures while using lower sample volumes.

All Discovery Hybrid Rheometers feature TA's patented **Magnetic Thrust Bearing** which reduces basic system friction by 70% compared to traditional designs. By eliminating the contributions of high pressure, turbulent air flow from the measurement system, lower torques can be measured reliably and accurately.

The unparalleled sensitivity of the magnetic thrust bearing is coupled with the NEW improved **Advanced Drag Cup Motor**. Enhanced torque precision increases the accuracy of every measurement, especially at low torques.

The measurement you want: Advanced Strain and Stress Control

The Discovery Hybrid Rheometer performs the experiment you want, whether stress-controlled, strain-controlled, or both. State-of-the-art high-speed electronics and the responsive Advanced Drag Cup Motor provide the fastest transient responses and accurate control in any type of deformation. Direct Strain oscillation provides real-time strain control at every point of the oscillatory measurement.

Responsive strain control ensures rapid data collection so you can characterize materials that are undergoing thermal, chemical, or structural transitions. Highly accurate deformation control (stress or strain) also ensures the highest data quality, particularly when evaluating materials that show a non-linear response at very large amplitudes.

(US Pat. 7,137,290; 7,017,393; 6,798,099)

Magnetic Thrust Bearing



Advanced Drag Cup

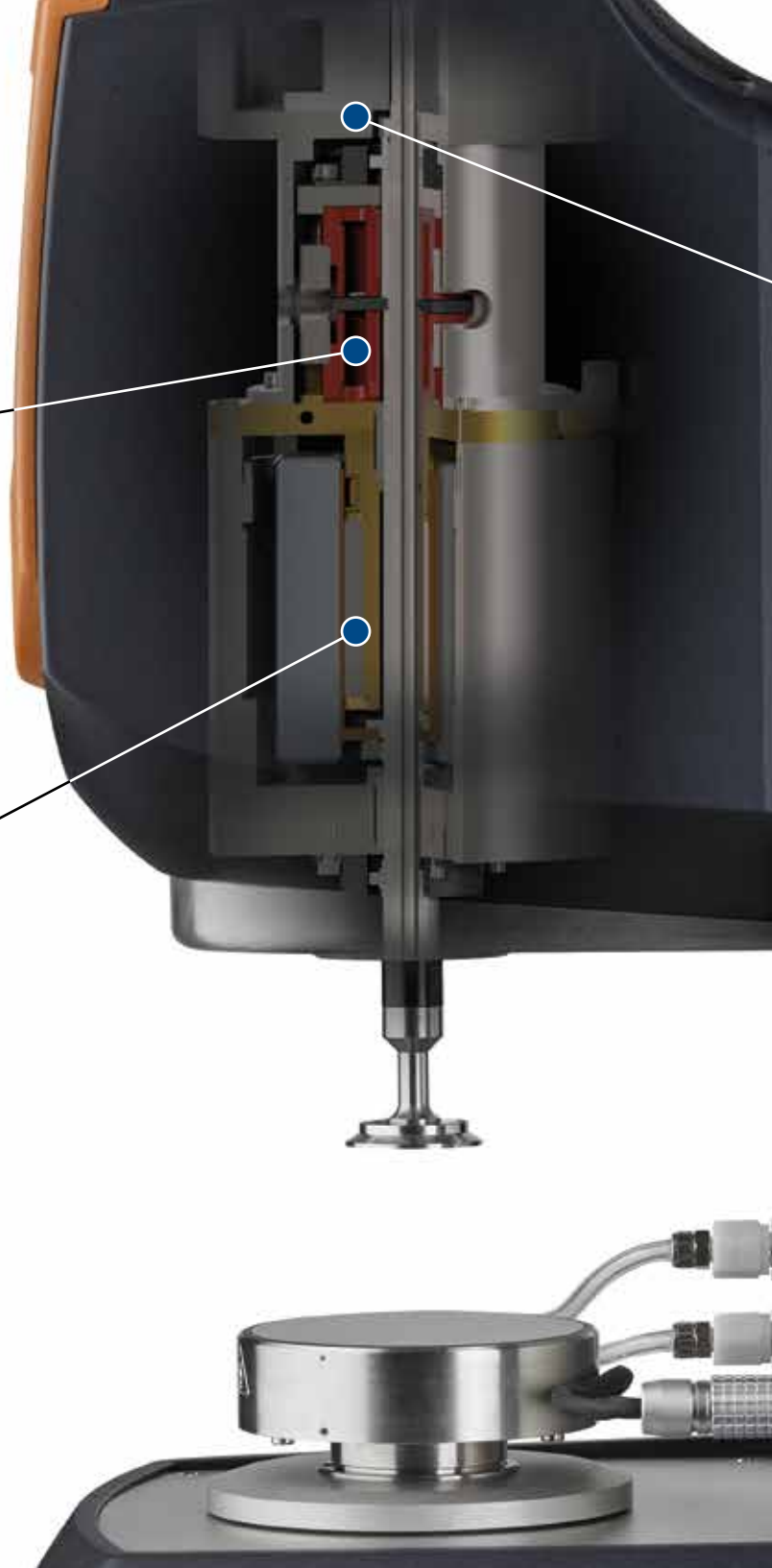
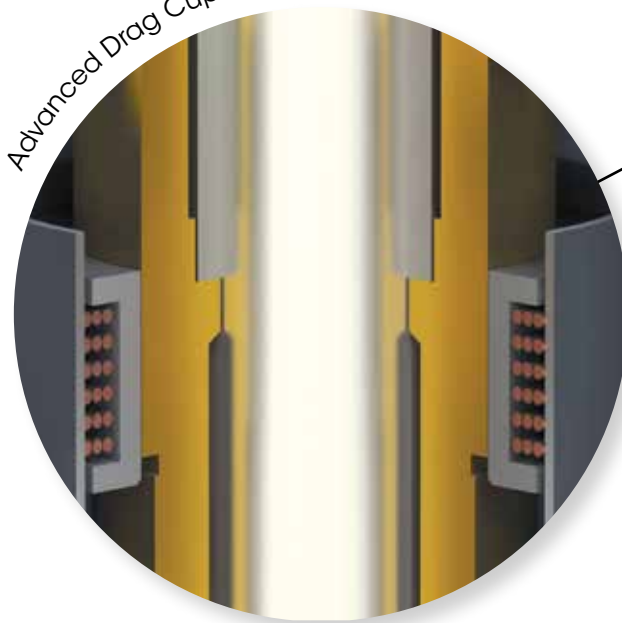

Optical Encoder Dual Reader



Report G' and G'' with confidence

The storage and loss modulus, G' and G'' , are two of the most insightful measurements provided by any rheometer.

The Discovery Hybrid Rheometer's exclusive **Optical Encoder Dual Reader** improves phase angle precision by 70% compared to conventional single-reader designs. This leads directly to a more accurate measurement of G' , G'' , and $\tan \delta$. This advantage becomes most evident under challenging experimental conditions such as low stresses, small strains, or difficult samples that exhibit only trace amounts of damping or elasticity. The Optical Encoder Dual Reader also provides a 5x improvement in displacement resolution, permitting more accurate measurements at lower strains.

The **Advanced Drag Cup Motor** is optimized for accuracy in dynamic measurements. The low-mass and -radius design reduces system inertia by up to 80% compared to DC motors, minimizing corrections to oscillation data, especially at higher measurement frequencies. The result is a wider range of accurate measurement frequencies, material types, and experimental designs.

MEASURE the **STIFFEST MATERIALS** with **CONFIDENCE** and **ACCURACY**

The Discovery Hybrid Rheometers are designed with sensitivity to measure the softest materials, and are constructed to be rugged enough to handle the stiffest materials and toughest users.

A rigid **cast aluminum frame and rugged linear ball slide** provide more than 60% greater axial and torsional stiffness than other designs and permit gap position resolution of 0.02 μm .

Two **high-stiffness radial bearings** stabilize the system from side loads exerted by samples or operators while the **Optical Encoder Dual Reader** further cancels displacement measurement drift associated with testing very stiff samples over long times.

The **Advanced Drag Cup Motor** provides stable control and measurement even when operating under extreme conditions. Active and passive thermal systems manage heat and account for system temperature, guaranteeing measurement accuracy under all test conditions.

These innovations provide the most accurate and sensitive measurement, under even the most extreme experimental conditions.

(US Pat #6,798,099)

Advancing Every Aspect of the Rheological Measurement

True Position Sensor

The DHR includes the patented True Position Sensor (TPS) for true gap accuracy. The TPS is a high-resolution linear position sensor that **measures and compensates for the effects of thermal expansion in real time**. Unlike competitive devices, the TPS eliminates errors associated with thermal expansion without the need for special high inertia iron core geometries and environmental systems.

The TPS works with all Smart Swap™ geometries and Smart Swap™ environmental systems.

(US Pat #10,161,843)

Normal Force Rebalance Transducer (FRT)

The Force Rebalance Transducer is the premier technology for normal force measurements. This active, non-compliant device accurately measures normal and axial forces without deflection. Competitive capacitive or strain gauge sensors rely on physical movement of the device to sense a force, resulting in measurement error. The FRT provides the most accurate normal force measurement by driving the linear motor to maintain zero deflection at all times and conditions. The FRT also works in conjunction with the magnetic thrust bearing to enable **axial DMA capability**.

Rigid Cast Aluminum Frame

Radial Bearings

Normal Force Rebalance Transducer (FRT)

True Position Sensor (TPS)

DISCOVER the RHEOMETER that WORKS WITH YOU

The NEW Discovery Hybrid Rheometer is your invisible partner in the lab, reducing the time from question to insight.

Load samples with confidence and ease

The Discovery Hybrid Rheometer is designed by rheometer users to make sample loading faster, easier, and improve measurement precision for every operator.

Expedite routine interactions with a gap positioning system that is **3x faster** than other rheometers while maintaining a 0.02 μm gap resolution. A **convenient tactile keypad** places the most common actions where you need them most, including thoughtful features like automated trim gap, measurement position, and bearing lock.

Even more power is offered by the new **One-Touch-Away™** app-style touchscreen that greatly enhances usability by placing key instrument features at your fingertips.

Every user will appreciate the brand new **integrated 360° sample stage lighting** that enhances visibility in any lab environment. The result is easier, more repeatable sample loading and trimming, leading to improved data accuracy and precision.

Versatility is being ready to face whatever the day brings. Whatever that may be, the NEW Discovery Hybrid Rheometer will be ready. The Discovery Hybrid Rheometer features the **widest range of powerful, easy-to-use environmental systems and accessories** that allow you to replicate demanding environmental conditions, incorporate complementary simultaneous measurements, or extend your rheometer beyond conventional shear rheology.

Smart Swap™ Geometries

The NEW Smart Swap 2™ geometry system features an all new system for optical information storage and transfer. This system provides greater storage and durability than chip-based systems. When attached, the complete geometry information, including unique dimensions is automatically detected and the software is appropriately configured.

Smart Swap Temperature Systems and Accessories

Only TA Instruments offers the convenience and versatility of Smart Swap temperature control options and accessories. Smart Swap options are attached to the instrument on its unique magnetic base, providing faster, easier installation than mechanical systems. Once attached, the instrument automatically detects and configures the system for operation.



Integrated 360° Sample Stage Lighting

Smart Swap™ Geometries

Smart Swap Temperature Systems & Accessories

Convenient Tactile Keypad

DHR | DYNAMIC MECHANICAL ANALYSIS (DMA)



Backed by over four decades of TA Instruments' expertise in rotational rheology and linear DMA measurements, the Discovery Hybrid Rheometer's DMA Mode adds a new dimension for testing solid and soft-solid materials. Now in addition to the most sensitive and accurate rotational shear measurements, the DHR can deliver accurate **linear Dynamic Mechanical Analysis (DMA) data**. Controlled axial oscillations permit the direct measurement of E' , E'' , and $\tan \delta$ in tension, bending and compression, a perfect addition to shear measurements, including solids in torsion. The new DMA mode is ideal for identifying a material's transition temperatures and provides reliable measurements over the instrument's full range of temperatures.

The axial DMA capability is enabled by the DHR's active Force Rebalance Transducer (FRT) and patented magnetic bearing technologies that permit amplitude-controlled oscillatory deformation in the axial direction. Installation of external components is never required, so it is always quick and easy to get great data! Competitive instruments that employ air bearings and passive normal force measurements are inherently incapable of such measurements without costly modifications.

Every Discovery Series HR 30 rheometer includes this DMA capability and it may be added to any HR 20.



ABS bar - Cantilever 3 mm x 12.75 mm x 25 mm

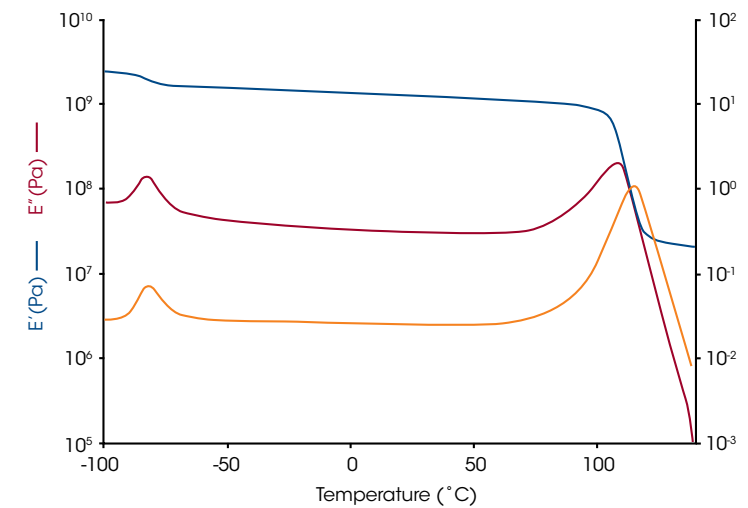

The figure above demonstrates the performance of the DMA mode during a temperature ramp of an acrylonitrile butadiene styrene (ABS) sample in single cantilever from -100 °C to 140 °C. Two major transitions corresponding to the individual glass transitions of the styrene (-82 °C) and butadiene (115 °C) components are evident, indicating the incompatibility of the two monomers.

PET Film - Tension 50 μm thick

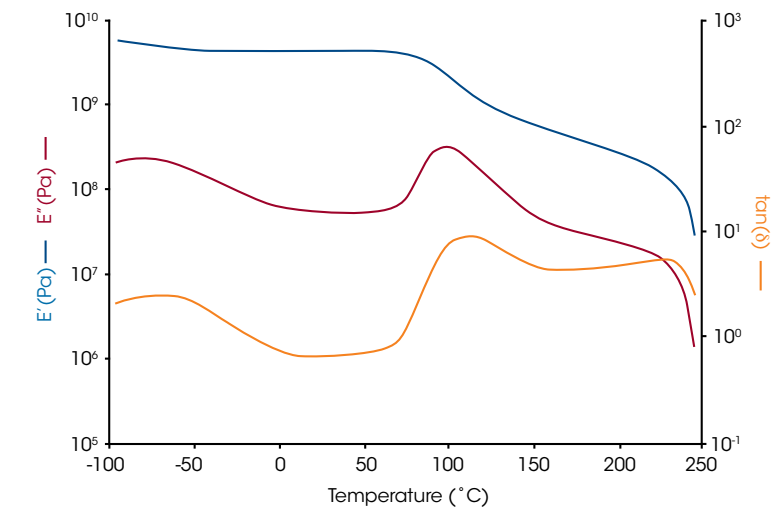

Axial DMA tests on thin films require maintaining the axial force above the oscillation force to hold the sample in tension throughout the test. This capability is highlighted in the plot above, showing the results of a temperature ramp on a 50 μm thick PET film tested using the tension geometry over a temperature range of -100 °C to 250 °C. Three major transitions are observed: a beta glass transition at -80 °C, an alpha glass transition at about 111 °C, and a melt at 236 °C. The data reveal a semi-crystalline structure with two amorphous relaxations and the DHR's force-tracking capabilities at work.



One
Touch
Away™

Revolutionary rheometer performance at your fingertips

The new Discovery Hybrid Rheometer boasts a brand-new One-Touch-Away™ app-style touchscreen that greatly enhances usability by placing key instrument features at your fingertips.

- Ergonomic design for easy viewing and operation
- Packed with functionality to simplify operation and enhance user experience

The app-style touchscreen includes:

- Start/stop experiments
- Set temperature
- Set gap
- Controlled rotation for sample loading
- Procedure and sample details
- Real-time signals
- Test and instrument status at a glance
- User prompts

The app-style touchscreen, powerful new TRIOS software, and quick robust calibration routines work seamlessly to dramatically improve laboratory workflows and productivity.

TA Instruments' state-of-the-art software package uses cutting-edge technology for instrument control, data collection, and data analysis for thermal analysis and rheology. The intuitive user interface allows you to simply and effectively program experiments, and move easily between processing experiments and viewing and analyzing data.



TRIOS Features:

- Control multiple instruments with a single PC and software package
- Overlay and compare results across techniques including DSC, TGA, DMA, SDT, TMA and rheometers
- Unlimited licenses and free lifetime software upgrades
- One-click repeated analysis for increased productivity
- Automated custom report generation including: experimental details, data plots and tables, analysis results
- Convenient data export to plain-text, CSV, XML, Excel®, Word®, PowerPoint®, and image formats
- Optional TRIOS Guardian with electronic signatures for audit trail and data integrity including U.S. FDA 21 CFR 11 compliance

TRIOS Software provides the right experience for every user

TRIOS for the Discovery Hybrid Rheometer features two powerful user interfaces that present users with what they need to collect the data they want.

TRIOS Express helps users to design the most common measurements quickly and easily. Simple forms and sensible defaults streamline the process of experiment design and execution.

TRIOS Unlimited gives you complete control. A robust set of detailed experimental controls and data collection options ensures that you will be able to design the experiment you envision and collect the data you need.

Complete Data Record

The advanced data collection system automatically saves all relevant signals, active calibrations, and system settings. **Waveforms for each data point** may be displayed as Lissajous plots and provide a visual representation of the stress-strain relationship. This comprehensive set of information is invaluable for method development, procedure deployment, and data validation.

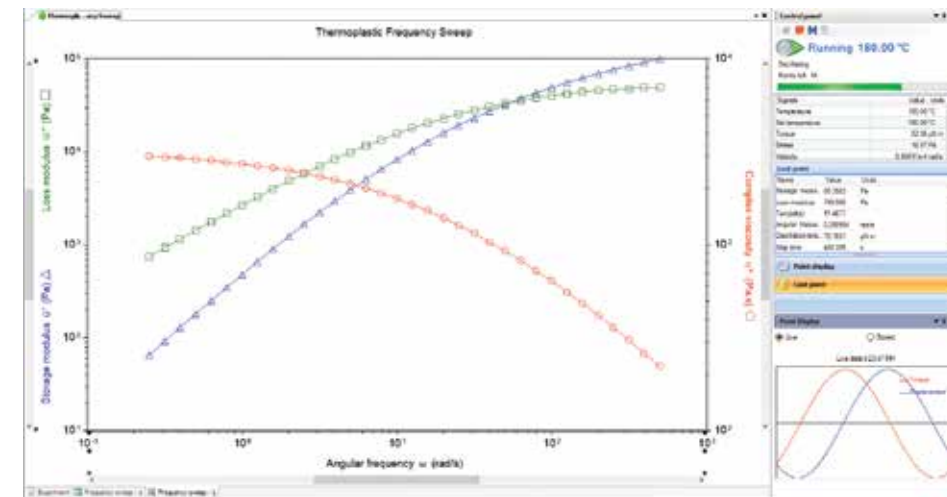

The Most **VERSATILE CONTROL** and **ANALYSIS SOFTWARE!**

Complete Data Analysis Capabilities

A comprehensive set of relevant tools are available for real-time data analysis, even during experiments. Gain actionable insights into your material behavior through a powerful and versatile set of features seamlessly integrated into TRIOS.

All Standard Analyses

- Onset and endset analysis
- Signal maximum and minimum
- Signal change
- Modulus crossover
- Curve values at specific X or Y points
- 1st and 2nd derivatives
- Area under the curve
- Peak height
- Peak integration and running integral
- Mathematical fitting: straight line, polynomial, or exponential
- Statistical functions

Advanced Analysis Capabilities

- More than 10 flow models including automatic model selection based on best fit to experimental data
- Time-Temperature Superposition (TTS) analysis with automatic curve shifting and Mastercurve generation
- Activation Energy calculation
- WLF coefficient calculation
- Convert between temperature ramps and frequency sweeps
- Cole-Cole, Van Gorp-Palmen, and Lissajous plots
- Built-in models for: discrete and continuous relaxation or retardation spectra, Oldroyd and Spriggs models
- Creep ringing analysis by Kelvin, Maxwell, or Jeffreys models

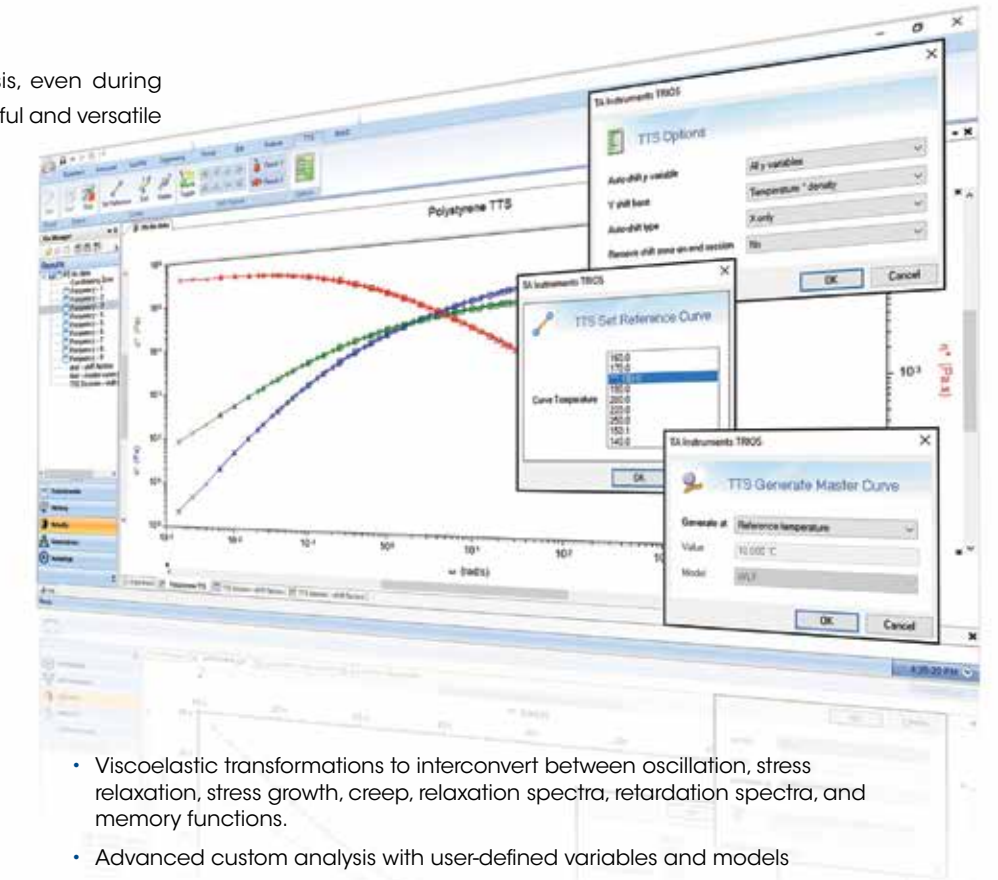

- Viscoelastic transformations to interconvert between oscillation, stress relaxation, stress growth, creep, relaxation spectra, retardation spectra, and memory functions.
- Advanced custom analysis with user-defined variables and models
- Cox-Merz: $\eta^*(\omega) \rightarrow \eta(\dot{\gamma})$
- Fluid Inertia Correction
- Rabinowicz Correction
- Direct Creep - Oscillation conversion
- Discrete Fourier Transformation (DFT)
- Window Correlation

TECHNOLOGY | AUTOPILOT SOFTWARE

Experience a new paradigm in software functionality and unleash the full potential of your Discovery Hybrid Rheometer with AutoPilot, a premium feature that enables complete automation of powerful TRIOS software. AutoPilot allows users to quickly and easily create automated routines: from test methods to data analysis and report generation. These routines empower laboratories to streamline and standardize operations and decision-making across local or global laboratory enterprises. From quality control to research and development, laboratory environments of all types will benefit from increased productivity, improved data precision, and reduced training time.



Simplified Interface

AutoPilot includes a customizable TRIOS ribbon and One-Touch, a simplified single-click PC user interface. Save time by centrally locating standard operating procedures (SOPs) in the configurable One-Touch layout. Quickly execute common tasks using custom TRIOS ribbon buttons. With a single click, operators will be able to reliably and repeatably execute complex procedures.

- One-Touch interface provides easy organization and execution of scripts
- Increase efficiency and productivity using custom ribbon buttons to repeat routine tasks
- Personalized button settings provide easy recognition of script functionality

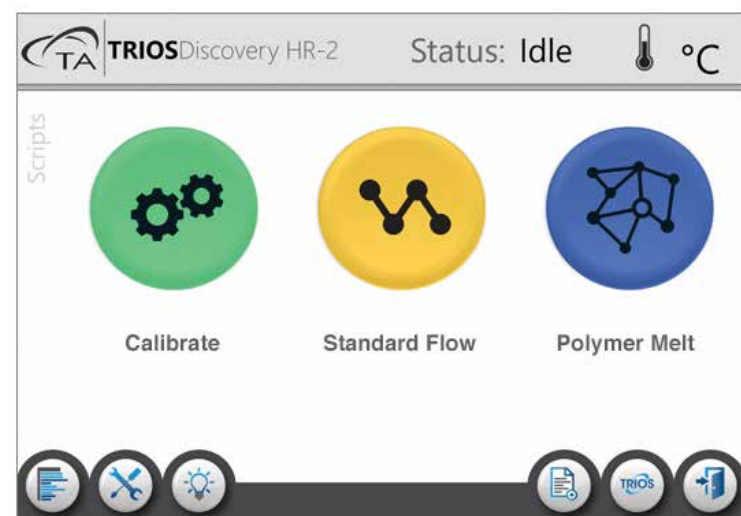

One-Touch Icon View

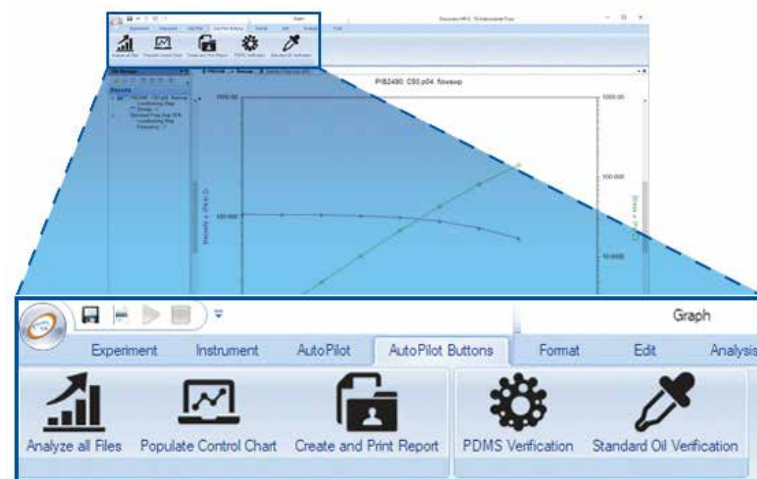

Custom TRIOS Ribbon



LIMS/NOTEBOOK

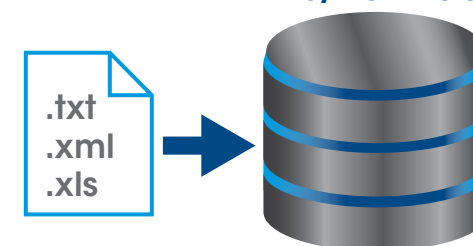

Guided Operation

AutoPilot allows for guided operation of the Discovery Hybrid Rheometer. Utilize available audio and video playback capability and interactive prompts to instruct users on proper operational techniques.

- Simple message boxes provide basic text feedback
- Prompt operators for experiment parameters
- Play videos to show proper sample loading, trimming, and cleaning technique
- Play sounds to provide audible indicators during script execution
- Timers provide visual indication of time remaining in current step

Unlimited Power

AutoPilot provides the ability to automate all the powerful TRIOS functions like data analysis and report generation, plus instrument actions like calibrations and temperature and gap commands. With more than 100 programmable operations, users can:

- Monitor live signal values to detect loading errors or dynamically change test parameters
- Load existing data sets for processing and trend analysis
- Create overlays, generate reports, and populate control charts
- Automate decision making on processed data

Intuitive Programming

AutoPilot scripts are built using Blockly, a visual programming interface developed by Google. The drag and drop constructs enable effortless script creation. Perform complex tasks out of the box using the included example scripts or create your own using Quick Steps and Express Scripts preconfigured routines that enable the rapid development of intricate procedures.

- Color-coded, puzzle-piece programming
- Requires little or no training
- Progressively grow your capabilities using the included examples and built in Quick Steps and Express Scripts

LIMS Compatibility

AutoPilot provides a seamless mechanism for integration into any LIMS system. Programmatically export raw data for incorporation by any third-party. Out-of-the-box supported formats include .txt, .xml, and .xls.

All DHR temperature systems and accessories are designed with superior performance and ease-of-use in mind. Only TA Instruments' DHR offers the convenience and versatility of Smart Swap™ geometries, temperature systems, and accessories. Smart Swap™ technology provides **fast and easy interchange of accessories** with automatic detection and configuration of the rheometer for operation.



Peltier Plate

Our best-selling temperature control system is the Peltier Plate. It can handle the widest range of material applications with standard, stepped, and disposable models. Temperature range is -40 °C to 200 °C with controllable heating rates of up to 20 °C/min. Peltier Plate accessories include evaporation blocking, thermal covers, purge covers, and immersion capability. It is the **highest performing, most versatile, and best accessorized Peltier Plate temperature system on the market.**



Peltier Concentric Cylinder

The DHR patented Peltier Concentric Cylinder combines the convenience of Smart Swap™ and Peltier heating technology with a wide variety of cup and rotor geometries. Concentric cylinder geometries are commonly used for testing low viscosity fluids, dispersions or any liquids that are pourable into a cup. Convenient Peltier technology provides stable and responsive temperature control from -20 °C to 150 °C. (Patent # 6,588,254)



Electrically Heated Concentric Cylinder

The new Electrically Heated Concentric Cylinder (EHC) system extends the temperature of concentric cylinder measurements to 300 °C. Efficient electrical heaters and optimized heat transfer ensure the most accurate and uniform temperature control. The EHC is compatible with a wide variety of concentric cylinder accessories, including the popular Pressure Cell.

The **World's** most **Versatile** platform for **Rheological Measurements**



Electrically Heated Plates, EHP

Provides active heating and cooling of cone and parallel plate geometries to a maximum temperature of 400 °C. Optional Gas Cooling Accessory extends the temperature to -70 °C. The EHP is ideal for high-throughput polymer sample testing. With patented Active Temperature Control, (ATC), it is the only EHP system capable of direct temperature control of the upper and lower plates. Standard and disposable systems are available for polymer melt and thermosetting materials. A camera viewing option is available.



Dual Stage Peltier Plate

The Dual Stage Peltier Plate is another first from the innovator of Peltier Plate technology. The unique design uses a stacked Peltier element approach. The benefit is unprecedented low temperature performance providing a continuous temperature range of -45 °C to 200 °C with water circulating at a single heat sink temperature. The Dual Stage Peltier is the perfect choice for applications requiring sub-ambient temperature control.



Upper Heated Plate, UHP

The UHP is a temperature option designed for use with Peltier plates to help minimize vertical temperature gradients. The UHP is compatible with all Peltier plate models and provides both upper plate temperature control and purge gas environment. The UHP has a maximum temperature of 150 °C and the lower temperature can be extended using liquid or gas cooling options. The UHP is the only non-contact temperature system to feature patented **Active Temperature Control for direct measurement and control of the upper plate temperature.**

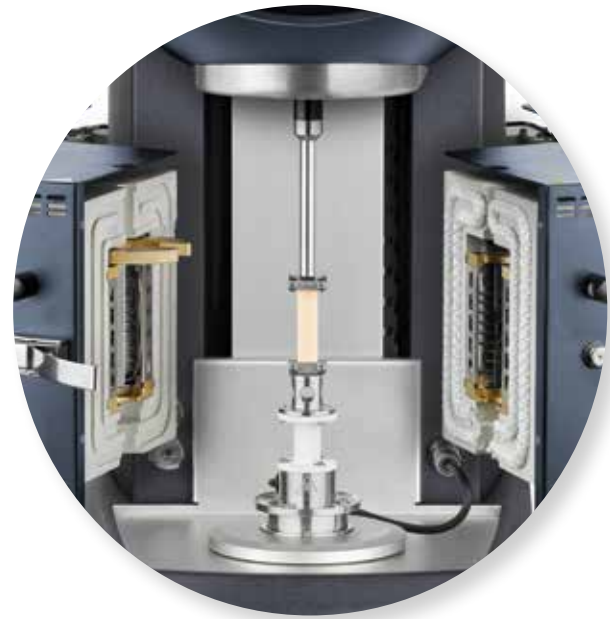

Environmental Test Chamber, ETC

The ETC is a high temperature Smart Swap™ oven that uses controlled convection/ radiant heating. Temperature range is -160 °C to 600 °C with heating rates up to 60 °C/ min, providing fast response and temperature stability. The ETC is a very popular option for polymer applications and can be used with parallel plate, cone and plate, disposable plate, rectangular torsion, and **axial DMA clamps for solids**. Image capture and camera viewing is optionally available over the entire temperature range.



Air Chiller Systems (ACS-2 and ACS-3)

The new Air Chiller Systems are unique gas flow cooling systems that enable temperature control of the Environmental Test Chamber without the use of liquid nitrogen. Equipped with multi-stage cascading compressors, the ACS-2 and ACS-3 permit operation of the ETC at temperatures as low as -50 °C and -85 °C, respectively. Utilizing compressed air, the Air Chiller Systems can help **eliminate or reduce liquid nitrogen usage from any laboratory** and offer an incredible return on investment.



Relative Humidity Accessory

The DHR-RH Accessory is a new environmental system that enables accurate control of sample temperature and relative humidity. The accessory employs a custom-designed humidity and temperature chamber that is optimized for rheological measurements and provides stable, reliable control of temperature and humidity over a wide range of operating conditions. A wide variety of test geometries are available, including geometries specially designed to study true humidity-dependent rheology.





Solvent Trap/Evaporation Blocking System

Solvent Trap cover and Solvent Trap geometries together create a thermally stable vapor barrier, virtually eliminating any solvent loss during rheological experiments and improving temperature uniformity.



Insulating Thermal Covers

Thermal Insulation Covers are constructed of an anodized aluminum core surrounded by an insulating exterior. The aluminum core conducts heat to the upper geometry, providing uniform temperature throughout the sample. Insulated Solvent Traps offer the added benefit of preventing evaporation.



Purge Gas Cover

The Purge Gas Cover is a hard-anodized aluminum two-piece split cover with 4 mm diameter compression fittings. This cover can be used to purge the sample area with dry nitrogen gas to prevent condensation below room temperature, or purge with humidified gas to prevent sample drying.

Advanced Peltier Plate

The Advanced Peltier Plate **combines ultimate flexibility with exceptional temperature performance** in a single Peltier Plate temperature system designed to cover the widest range of applications. The unique Quick Change Plate system provides the ability to easily attach lower plates of different materials and surface finishes, disposable plates for testing curing materials, and an Immersion Cup for characterizing materials in a fluid environment.





Optics Plate Accessory, (OPA)

The OPA is an open optical system that permits basic visualization of sample structure during rheological experiments, revealing important insights about material behavior under flow. An open platform with a borosilicate glass plate provides a transparent optical path through which the sample can be viewed directly. This enhances the understanding of a range of materials, especially suspensions and emulsions.



Modular Microscope Accessory, (MMA)

The (MMA) enables complete flow visualization with simultaneous rheological measurements. A high-resolution camera collects images at up to 90 fps coupled with industry-standard microscope objectives that provide magnification up to 100x. Illumination from a blue-light LED can be combined with a cross-polarizer or dichroic splitter for selective illumination or fluorescence microscopy.



Small Angle Light Scattering, (SALS)

The SALS option provides simultaneous rheological and structural information such as particle size, shape, orientation, and spatial distribution. The accessory features patented Peltier Plate temperature control, scattering angle (θ) range of 6° to 26.8° , scattering vector range (q) of $1.38 \mu\text{m}^{-1}$ to $6.11 \mu\text{m}^{-1}$. Length scale range is $1.0 \mu\text{m}$ to about $4.6 \mu\text{m}$.
(Patent # 7,500,385)



Rheo-Raman Accessory

The new Rheo-Raman Accessory allows for simultaneous collection of Raman spectroscopy data during rheology experiments. Raman spectroscopy is a technique that provides critical information about molecular structure and bonding and can elucidate intermolecular interactions of pure components and mixtures. The Rheo-Raman Accessory from TA Instruments integrates with the iXR Raman Spectrometer™ from Thermo Fisher Scientific™ to provide a turnkey, safe system with Class 1 laser certification.



Interfacial Rheology: Double Wall Ring and Double Wall Du Noüy Ring

Patented technologies allow the characterization of interfacial rheology using specialized geometries to measure the viscosity and viscoelastic properties at two-dimensional liquid-air and liquid-liquid interfaces. The well-defined flows and negligible sub-phase contributions in the Double Wall Ring (DWR) and Double Wall du Noüy Ring (DDR) make these tools the preferred choice for sensitive measurements of interfacial rheology. In TA Instruments interfacial rheology systems, the sample is contained in a Delrin® trough with measuring geometries made of Platinum-Iridium. These materials are selected for their inert chemistry and ease of cleaning. The choice of different interfacial rheology options gives you the greatest flexibility in choosing the appropriate geometry for your application.
(Patent # 7,926,326)



Interfacial Exchange Cell

The new Interfacial Exchange Cell expands TA Instruments' patented offerings for interfacial rheology by providing the ability to directly manipulate the composition of the lower liquid layer (subphase) during rheological measurements. This unique capability enables the characterization of the interfacial response to a modified subphase composition, opening possibilities for quantifying the effects of changes in pH, salt, or drug concentration, or the introduction of new proteins, surfactants, or other active ingredients.



ETC Geometry Accessory Kits

The kits feature standard geometries configured for testing thermoplastics and rubber, thermosetting and other curing systems, pressure-sensitive adhesives and asphalt binders. A wide variety of stainless steel geometries of various diameters and cone angles, and disposable plates are also available to fully accessorize the temperature system.



ETC Torsion Clamp Kits

The Torsion Clamp Kits offer an easy way to test solid rectangular or cylindrical samples under shear deformation on the rheometer. This type of torsional testing can be used to study transition temperatures and evaluate blend compatibility in multi-component polymeric samples.



SER3 Universal Testing Platform

The SER3 is a universal testing platform to perform extensional rheology measurements and a range of physical material property measurements such as tensile, peel, tear and friction on small solid samples.



Dielectric Analysis

Dielectric analysis is a powerful technique that measures electrical properties such as capacitance and conductance. It can be used to characterize polar materials such as PVC, PVDF, PMMA, and PVA, phase separating systems, and monitor curing kinetics in materials such as epoxy and urethane systems. Dielectric analysis can measure at frequencies as high as 2MHz, well beyond traditional mechanical limits.

Tribo-Rheometry

The new Tribo-Rheometry Accessory enables measurement of the coefficient of friction between two solid surfaces under dry or lubricated conditions. The unique self-aligning design ensures uniform solid-solid contact and axial force distribution under all conditions. A **modular set of standard and novel geometries** offers a choice of different contact profiles and direct simulation of end-use conditions.





Pressure Cell

An optional sealed vessel for studying the effect of pressure on rheological properties or materials that volatilize under atmospheric pressure. Can be used to a pressure up to 138 bar (2,000 psi) and to a maximum temperature of 300 °C.



High Sensitivity Pressure Cell (HSPC)

For complete viscoelastic characterization of fluids near, or above their boiling point or under pressure, the (HSPC) provides 100x better torque sensitivity than conventional mechanically-sealed pressure vessels. Measure low viscosities and accurate G' and G'' at pressures up to 5 bar, including aqueous systems at temperatures as high as 150 °C.



Starch Pasting Cell (SPC)

The (SPC) is a powerful and accurate tool for rheological characterization of the gelatinization process and final properties of starch products or basic characterization of many other highly unstable materials.



Building Materials Cell

The Building Materials Cell is a specially designed, abrasion-resistant and durable concentric cylinder cup and rotor for testing samples with large particles such as concrete slurries and mixes. The paddle-type rotor, slotted cage, and the large diameter cup promote adequate sample mixing while preventing sample slip at both the cup and rotor surfaces.



Torsion Immersion Cell

The Torsion Immersion Cell allows rectangular bar-shaped samples to be clamped and characterized while immersed in a temperature-controlled fluid. The resulting change in mechanical properties, caused by swelling or plasticizing, can be analyzed in oscillatory experiments.



Electrorheology

Allows characterization of electro-rheological fluids with a voltage up to 4000 V in both DC and AC modes. Features parallel plate and concentric cylinder geometries and a maximum temperature of 200 °C. Flexible programmable voltage profiles such as step, ramp, sine, and triangle wave functions as well as functions with DC offsets.



Magneto-Rheology (MR)

The new MR Accessory enables the complete characterization of magneto-rheological fluids under the influence of a controlled field. Applied fields up to 1 T and a sample temperature range of -10 °C to 170 °C make the MR Accessory ideal for all studies of MR fluids and ferrofluids.



Immobilization Cell

The new Immobilization Cell Accessory permits the characterization of drying, retention, and immobilization kinetics of paints, coatings, and slurries. Solvent is dewatered from the sample through a paper substrate affixed to a perforated lower plate under controlled temperature and vacuum. Rheological changes in the sample during this immobilization process are simultaneously quantified through an oscillatory time sweep test with controlled axial force.



Generic Container Holder

The Generic Container Holder is a Smart Swap™ option that can hold any container with an outer diameter of up to 80 mm for characterizing materials with rotors. This allows for quick off-the-shelf evaluation of materials, such as paints and varnishes, creams, pasta sauce, etc., without creating large shearing from sample loading. It also is an excellent platform for beakers or jacketed beakers.



UV Curing Accessories

Two Smart Swap™ accessories for rheological characterization of UV-curable materials are available for the HR 10, HR 20, and HR 30. One accessory uses a light guide and reflecting mirror assembly to transfer UV radiation from an external high-pressure mercury light source. The second accessory uses self-contained light emitting diodes (LED) arrays featuring primary peaks of 365 nm and 455 nm. Both systems are compatible with optional disposable plates and temperature control up to 150 °C.



Dry Asphalt and Asphalt Submersion Systems

TA asphalt systems meet or exceed SHRP, ASTM, and AASHTO requirements and include 8 and 25 mm parallel plates and sample molds. The Dry Asphalt System combines our superior Upper Heated Plate with a unique lower stepped Peltier Plate. Flexible cooling options include Peltier, Vortex, and water circulator cooling. The Asphalt Submersion Cell employs the classic approach of temperature control by fully submersing the sample in circulating water.

FastTrack Software for Asphalt Binder Testing

FastTrack is a dedicated software package for ASTM and AASHTO compliant testing and grading of asphalt binders on the DHR rotational rheometers. Thoughtfully designed with the operator in mind, FastTrack consists of an intuitive, easy-to-use graphical interface and a full suite of tests relevant to the rheological testing of asphalt samples. Designed from the ground up, the intuitive interface visually guides the operator through the test procedure via a series of context-appropriate instructions and videos. Prominent visual cues convey the instrument's current status at a glance.

FastTrack offers a flexible configuration that can be completely optimized to match your testing needs. This includes testing of Original Binder, Rolling Thin Film Oven (RTFO) and Pressure Aged Vessel (PAV) residue samples, Multiple Step Repeated Creep (MSCR) and Large Amplitude Sweep (LAS). In addition, the Automated Temperature Calibration and Cannon standard verification tests make it easy to run these tests for routine calibration and audit purposes.



Flow Curve for Solutions and Dispersions

The Discovery Hybrid Rheometers generate flow curves as a function of stress or strain-rate. More often, a flow curve is generated based on stepped flow profile, where each data point reflects a steady-state measurement as determined automatically by the measurement system. The data generated provides information on yield stress, viscosity, shear thinning, shear thickening, or thixotropy, and correlates to processing and product performance. Simple techniques like spindle viscometers can only measure a point or a small part of the total flow curve. The broad operating range of the Discovery Hybrid Rheometer enables a complete characterization of the flow behavior of a material.

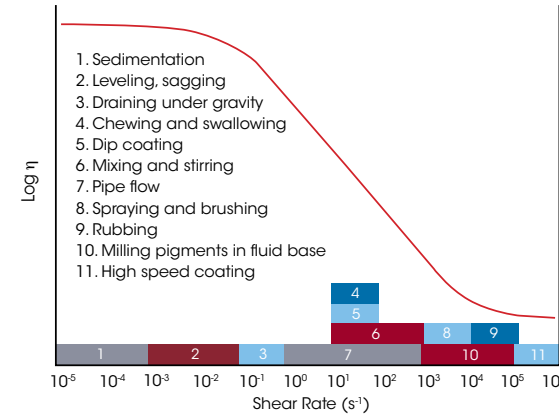

Flow Curve for Polymers

A polymer's molecular weight greatly influences its zero-shear viscosity, while its molecular weight distribution and degree of branching affect its shear rate dependence. These differences are most apparent at low shear rates not possible with melt flow index or capillary devices. In addition to basic information about flow behavior, this data can be used by the powerful TROS software to determine molecular weight based on the measured zero shear viscosity. Cox-Merz and TTS can be used to extend the data to higher shear rates by combining this data with data from oscillatory measurements.

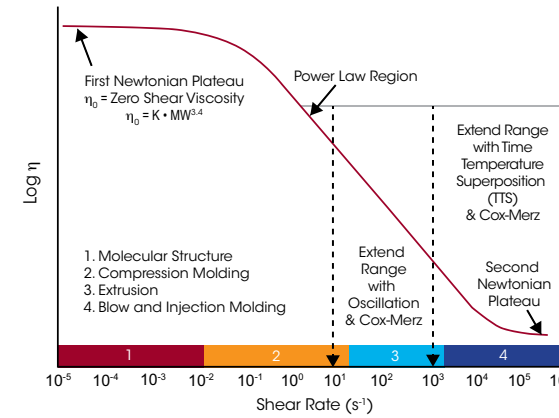

Creep and Recovery

Data from creep and recovery experiments performed on paint samples that were reported to have "good" and "bad" performance are shown in the figure to the right. This testing mode is a powerful tool for measuring viscoelastic properties and understanding and predicting material performance when under loads for long periods of time. Examples include settling stability in complex fluids, and zero shear viscosity (η_0) and equilibrium recoverable compliance (J_e^0) in polymer melts. Creep is an especially accurate and sensitive method for determining η_0 and very low levels of elasticity; it is best-suited for the unmatched stress-control and low inertia of the Discovery Hybrid Rheometer. A similar experiment, stress relaxation, may also be performed in which a step strain is applied, and stress is measured as a function of time. This experiment provides a stress relaxation modulus $G(t)$.

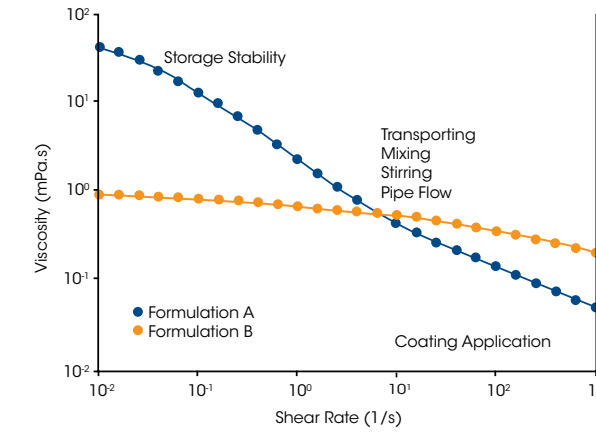
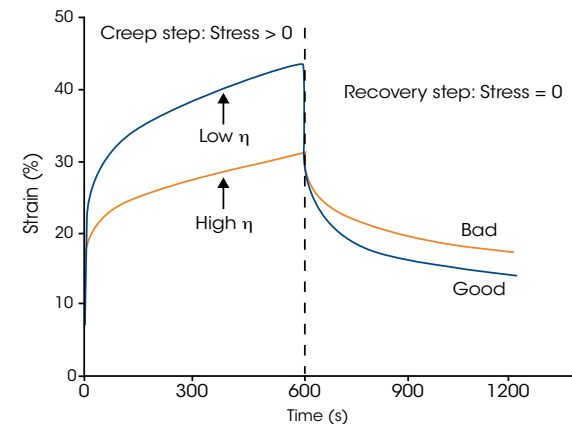

Flow Curve Predicts Suitability of an Adhesive Coating Formulation

Shear-thinning is an important trait, particularly in coating applications. A high viscosity at low shear rates is desirable to provide stability against settling of dispersed phases during storage. A low viscosity is desired at low rates to facilitate mixing, stirring, and transport through pipes. Most importantly, a low viscosity at higher rates is required to permit fast coating and a low film thickness. For the two formulations described to the right, both provide comparable moderate rate viscosity, but formulation A exhibits more desirable viscous behavior for both storage stability and coating performance.

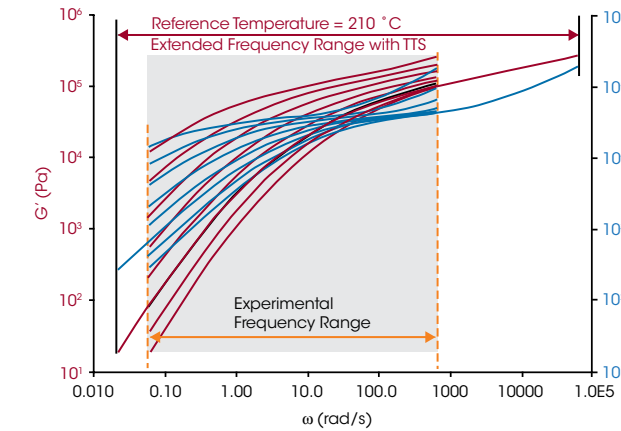

Viscoelastic Mastercurve

The adjacent figure illustrates a viscoelastic fingerprint for a linear homopolymer and the variation of G' and G'' as a function of frequency. As frequency is the inverse of time, the curve shows the time-dependent mechanical response, with short times (high frequency) corresponding to solid-like behavior and long times (low frequency) to liquid-like behavior. The magnitude and shape of the G' and G'' curves depend on the molecular structure. Frequency sweeps are typically run over a limited range of 0.1 to 100 rad/s. Time-temperature superposition (TTS) is often used to extend the frequency range by combining measurements made at several temperatures.

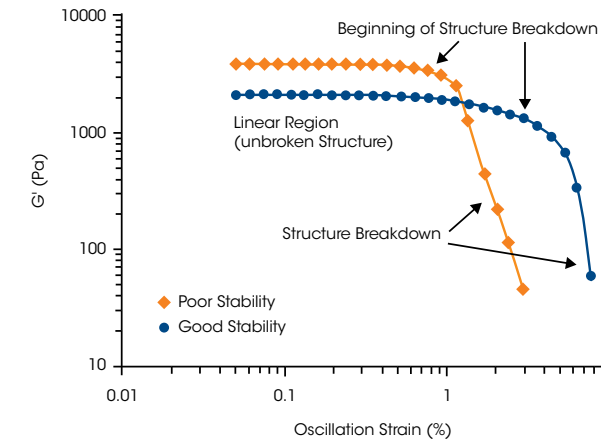

Strain Sweeps Predict Dispersion Stability

The accompanying figure contains the results of an oscillation strain sweep used to determine the linear viscoelastic region (LVR) and to investigate dispersion stability. In the LVR, the material responds linearly to the stress or strain (elastic) and the structure remains unchanged. The rapid drop of the modulus with strain represents breakdown of the material's structure. Once the structure has been disrupted, G' becomes dependent on the applied strain. A material with a large linear region is often found to be more resistant to phase separation or agglomeration.

Viscoelastic Structure Development

The elastic structure of a dispersion is helpful to hold shape or stabilize dispersed particles. It is often desirable that this structure be broken down easily under large deformations to facilitate transport or spreading, as in an architectural coating or paint. Once the deformation stops, the quiescent structure should recover quickly enough to stabilize the dispersion and prevent dripping, but slowly enough to allow relaxation or smoothing of brush streaks. The time-based measurement of G' and G'' allows for this process to be quantified and ensure that it occurs within a target window of time profiles.

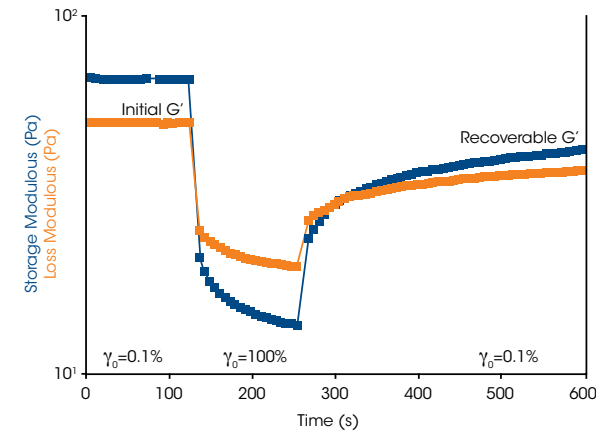

Extensional Viscosity Measurements

The Discovery Hybrid Rheometer can also perform extensional viscosity measurements of polymers melts when paired with the EVA (Extensional Viscosity Accessory) or SER3 (Sentmanat Extension Rheometer). Extensional viscosity measurements are shown for standard LDPE 1810H at 150 °C at extensional rates from 0.02 to 3 s⁻¹. These results are compared to three times the corresponding low shear rate viscosity, which agrees well with the zero-rate extensional viscosity prior to the onset of extensional thickening at different extension rates. In addition to extensional viscosity, these devices can also be used for solids tensile testing, tear testing, peel testing, as well as high-rate fracture testing, providing a natural complement to shear rheology that enhances material insights.

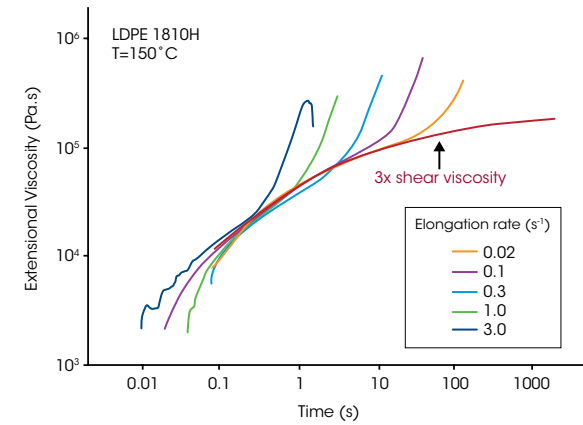

Coefficient of Friction Measurement

The accompanying figure shows the coefficient of friction profiles of two commercial toothpastes. The whitening toothpaste, with abrasive particles, has higher friction at low speeds, but the gel toothpaste's friction profile shows a rapid increase at higher speeds. This behavior can be explained by comparing the flow curves of the two toothpastes - although both materials are shear thinning, the viscosity of whitening toothpaste decreases more rapidly than the gel toothpaste. This results in increased hydrodynamic drag and greater friction at higher rotation speeds. Measurement of coefficient of friction is one of the many complementary measurements beyond shear rheology that are possible with the Discovery Hybrid Rheometer.

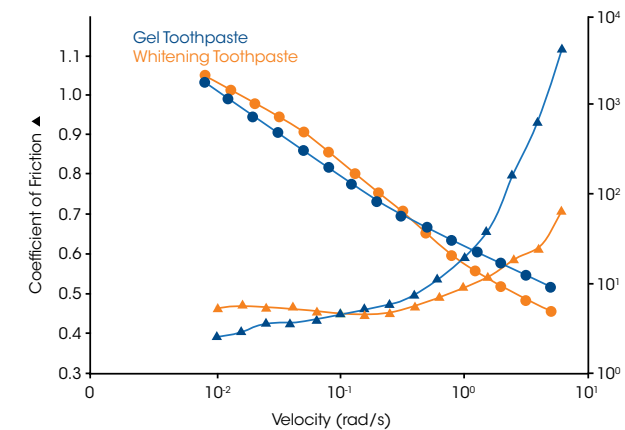

Determination of a Weak Yield Stress in a Suspension

Complex fluids often employ an engineered yield stress to support a suspended phase from settling or agglomerating, or to prevent a liquid from spreading at rest. This stress must be optimized such that it is large enough to prevent settling, but minimized so start-up of macroscopic flow is not hindered. The example data to the left shows the behavior of a beverage that suspends a dispersed phase. The yield stress and the post-yield viscosity must be low to allow easy pourability and acceptable sensory perception when drunk. The extremely sensitive measurement of the HR 30 allows for this very low yield stress (0.03 Pa) to be measured readily, and with ample data before the yield to clearly establish a pre-yield plateau.

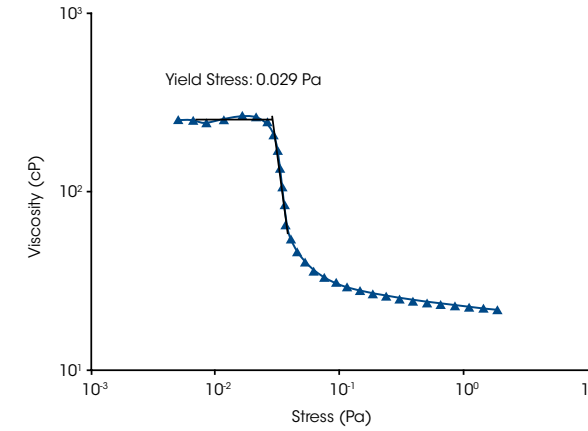

G' and G'' through cure improved by Optical Encoder Dual Reader

A thermoset resin may undergo a dramatic change in rheological properties as it moves through the curing process. Beginning as a low viscosity liquid to a high stiffness solid in a short period of time. It is, therefore, incumbent on the rheometer to make an accurate measurement over the full range of material properties with a single experimental set-up. The Optical Encoder Dual Reader improves phase angle, δ , and therefore G' and G'' accuracy under all measurement conditions. This can be readily seen in the example data to the left. A rheometer with a conventional single reader has difficulty accurately measuring G' before the cure or G'' after the cure. The HR 30 with Optical Encoder Dual Reader produces superior data in both cases.

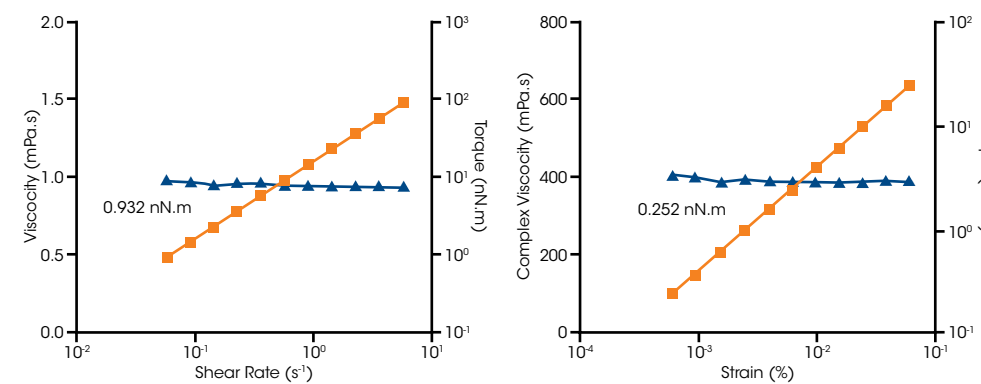
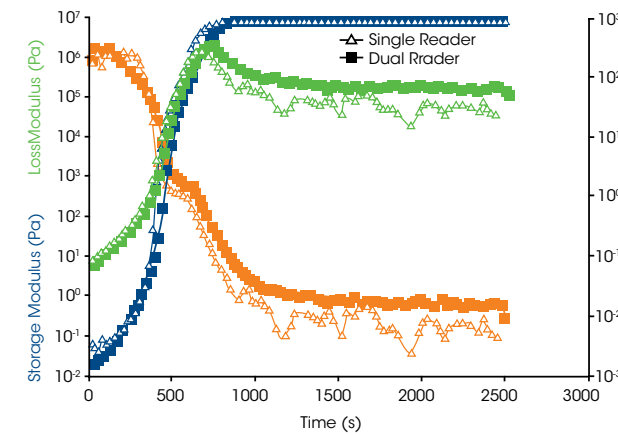

Advanced Technology for Superior Sensitivity

Exceptional torque accuracy and sensitivity enables measurements of lower viscosities, weaker intermolecular forces, and lower sample volumes. The low friction magnetic thrust bearing and high accuracy Advanced Drag Cup Motor allows the Discovery Hybrid Rheometer to achieve superior measurement sensitivity in both flow and oscillation conditions. This enables scientists to learn more about a material, while consuming less. One simple demonstration of this performance is the measurement of a Newtonian oil. These materials exhibit a constant viscosity at all shear rates, amplitudes, or frequencies. Simple measurements demonstrate that the HR 30 achieves sensitivity to 1 nN.m, and 0.3 nN.m or better in flow and oscillation testing conditions, respectively.

Technical Specifications

Specification	HR 30	HR 20	HR 10
Bearing Type, Thrust	Magnetic	Magnetic	Magnetic
Bearing Type, Radial	Porous Carbon	Porous Carbon	Porous Carbon
Motor Design	Drag Cup	Drag Cup	Drag Cup
Minimum Torque (nN.m) Oscillation	0.3	1	5
Minimum Torque (nN.m) Steady Shear	1	3	5
Maximum Torque (mN.m)	200	200	200
Torque Resolution (nN.m)	0.05	0.1	0.1
Minimum Frequency (Hz)	1.0E-07	1.0E-07	1.0E-07
Maximum Frequency (Hz)	100	100	100
Minimum Angular Velocity ^[1] (rad/s)	0	0	0
Maximum Angular Velocity (rad/s)	300	300	300
Displacement Transducer	Optical Encoder	Optical Encoder	Optical Encoder
Optical Encoder Dual Reader	Standard	Standard	N/A
Displacement Resolution (nrad)	2	2	10
Step Time, Strain ^[2] (ms)	15	15	15
Step Time, Rate ^[2] (ms)	5	5	5
Normal/Axial Force Transducer	FRT	FRT	FRT
Maximum Normal Force (N)	50	50	50
Normal Force Sensitivity (N)	0.005	0.005	0.01
Normal Force Resolution (mN)	0.5	0.5	1

[1] Zero in controlled stress mode. Controlled rate mode depends on duration of point being measured and sampling time.

[2] Results at 99% of commanded value

DMA Mode

Specifications	
Motor Control	Force Rebalance Transducer
Minimum Force in Oscillation	3 mN
Maximum Axial Force	50 N
Minimum Displacement in Oscillation	0.01 µm
Maximum Displacement in Oscillation	100 µm
Axial Frequency Range	6x10 ⁻⁵ rad/s to 100 rad/s (10 ⁻⁵ Hz to 16 Hz)

Instrument Features

Features	HR 30	HR 20	HR 10
Optical Encoder Dual Reader	●	●	—
DMA Mode	●	○	—
True Position Sensor (TPS)	●	●	●
Controlled stress (steady, transient, oscillation)	●	●	●
Controlled strain (steady, transient, iterative oscillation)	●	●	●
Direct Strain (oscillation)	●	●	○
Fast data collection	●	●	—
Normal Force measurements with FRT	●	●	●
Axial and tack testing	●	●	○
One-Touch-Away™ Display	●	●	●
Integrated Sample Lighting	●	●	●
FastTrack	●	●	●
AutoPilot	○	○	○

● Included ○ Optional — Not Available





AMERICAS

- New Castle, DE USA
- Lindon, UT USA
- Wakefield, MA USA
- Eden Prairie, MN USA
- Chicago, IL USA
- Costa Mesa, CA USA
- Montreal, Canada
- Toronto, Canada
- Mexico City, Mexico
- São Paulo, Brazil

EUROPE

- Hüllhorst, Germany
- Bochum, Germany
- Eschborn, Germany
- Wetzlar, Germany
- Elstree, United Kingdom
- Brussels, Belgium
- Eften-Leur, Netherlands
- Paris, France
- Barcelona, Spain
- Milano, Italy
- Warsaw, Poland
- Prague, Czech Republic
- Sollentuna, Sweden
- Copenhagen, Denmark

ASIA & AUSTRALIA

- Shanghai, China
- Beijing, China
- Tokyo, Japan
- Seoul, South Korea
- Taipei, Taiwan
- Guangzhou, China
- Petaling Jaya, Malaysia
- Singapore
- Bangalore, India
- Sydney, Australia



Waters
THE SCIENCE OF WHAT'S POSSIBLE.™

TA Instruments

159 Lukens Drive
New Castle, DE 19720 U.S.A.
T: 1 302 427 4000
F: 1 302 427 4041
www.tainstruments.com

Waters Corporation

34 Maple Street
Milford, MA 01757 U.S.A.
T: 1 508 478 2000
F: 1 508 872 1990
www.waters.com