

The ibidi product family is comprised of a variety of μ-Slides and μ-Dishes, which have all been designed for high-end microscopic analysis of fixed or living cells. The high optical quality of the material is similar to that of glass, so you can perform all kinds of fluorescence experiments with uncompromised resolution and choice of wavelength.

The μ-Slide I Luer 3D is a channel slide with three wells for gel matrices inside a channel for medium flow. The wells can be filled with a gel on which cells can

be cultivated, and subsequently, investigated with microscopical methods. The channel can be connected to a pump for applying defined shear stress.

Material

ibidi μ-Slides, μ-Dishes, and μ-Plates are made of a polymer that has the highest optical quality. The polymer coverslip on the bottom exhibits extremely low birefringence and autofluorescence, similar to that of glass. Also, it is not possible to detach the bottom from the upper part. The μ-Slides, μ-Dishes, and μ-Plates are intended for one-time use and are not autoclavable, since they are only temperature-stable up to 80°C/175°F. Please note that gas exchange between the medium and the incubator's atmosphere occurs partially through the polymer coverslip, which should not be covered.

Optical Properties ibidi Polymer Coverslip

Refractive index n_D (589 nm)	1.52
Abbe number	56
Thickness	No. 1.5 (180 μm)
Material	Polymer coverslip

Please note! The ibidi Polymer Coverslip is compatible with certain types of immersion oil only. A list of suitable oils can be found on page 6.

Geometry

The μ-Slide I Luer 3D provides a standard slide format according to ISO 8037/1.

Geometry of μ-Slide I Luer 3D

Outer dimensions	25.5 mm x 75.5 mm
Number of wells	3
Volume of each well	16 μl
Well dimensions	5.4 mm x 4.0 mm
Well height (without channel)	0.8 mm
Growth area per well	0.21 cm ²
Coating area per well	0.34 cm ²
Channel width	5.0 mm
Channel volume (without wells)	150 μl
Channel height (without well)	0.6 mm
Adapters	Female Luer
Volume per reservoir	60 μl
Top cover	No. 1.5 ibidi Polymer Coverslip
Bottom	No. 1.5 ibidi Polymer Coverslip

Shipping and Storage

The μ-Slides, μ-Dishes and μ-Plates are sterilized and welded in a gas-permeable packaging. The shelf life under proper storage conditions (in a dry place, no direct sunlight) is listed in the following table.

Conditions	
Shipping conditions	Ambient
Storage conditions	RT (15–25°C)
Shelf Life	
ibiTreat, Uncoated	36 months

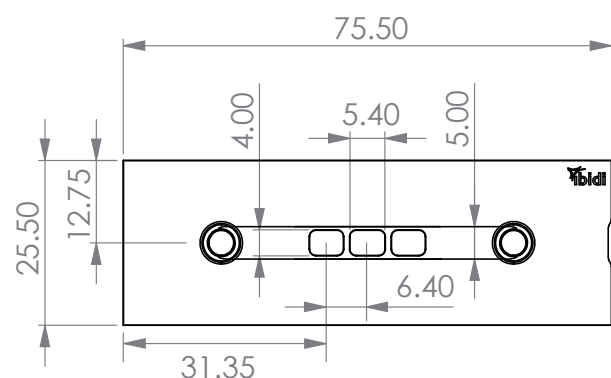

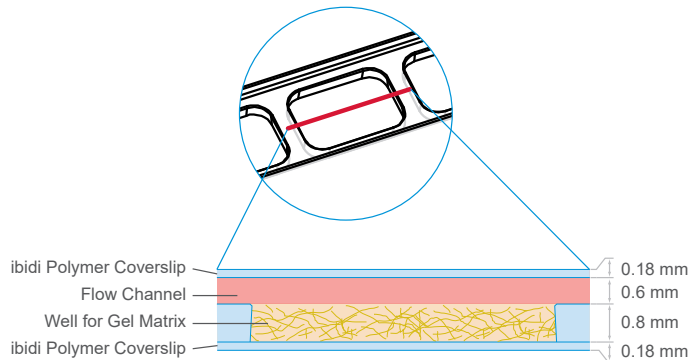

Surface

The tissue culture-treated ibiTreat surface is a physical surface modification. ibiTreat is hydrophilic while Uncoated is a very hydrophobic surface.

For assays with a gel matrix inside the wells, both surface modifications can be used directly. Optionally, for optimizing the attachment of the gel matrix to the well surface, both ibiTreat and Uncoated can be precoated with a mediating protein.

Coating

Detailed information about coatings is provided in [Application Note 08: Coating protocols for ibidi labware products](#).

In short, specific coatings are possible following this protocol:

1. Prepare your coating solution according to the manufacturer's specifications or reference.
2. Apply 16 μl and leave at room temperature for at least 30 minutes.
3. Aspirate the solution and wash with the recommended protein dilution buffer.
4. The μ-Slide I Luer 3D is ready to be used. Optionally let dry at room temperature. Attention, some coating proteins might degenerate when drying!

Gel Volume Optimization

The volume of the inner wells is exactly 16 μl. When the well contains the correct volume, no magnification or demagnification effect, such as seen in the picture below, is observed. To visualize the effect, hold the slide at a distance of a few centimeters over the scale paper below.

Because of the gel viscosity, remains in the pipet tip and general pipetting errors the volume ending up in the wells might be different from the set volume of your pipet. If the pipet setting of 16 μl does not result in meniscus-free filling, try slightly different volumes and check with scale paper to determine which setting is adequate for a flat gel surface.

Also, make sure to check the flatness of the gel surface after polymerization and after filling the channel again. Gels can swell or shrink depending on the environmental conditions. Re-adjust the volume accordingly.

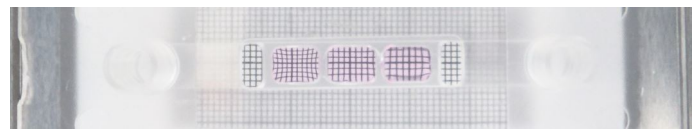

Example: μ-Slide I Luer 3D filled with a Collagen gel. Well 1 contains less than 16 μl. The grid looks diminished. Well 2 is filled with the adequate volume of 16 μl and shows no image distortion. Well 3 is filled with an excessive gel volume. The grid looks magnified.

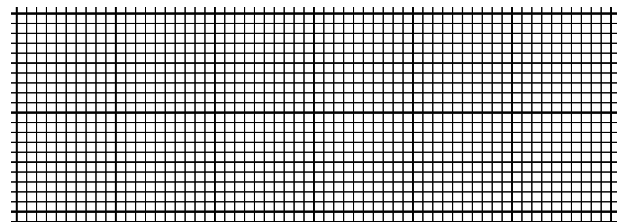

Scale paper for optimizing the gel volume

Gel and Cell Protocol

This section describes the standard protocol, seeding adherent cells on top of a gel matrix for applying defined shear stress on a cell monolayer.

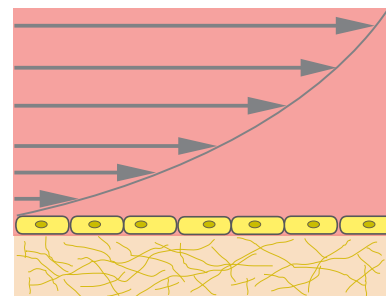

1. Prepare your gel matrix according to the manufacturer's protocol or reference.
2. Remove the protective foil on the upper side of the slide.

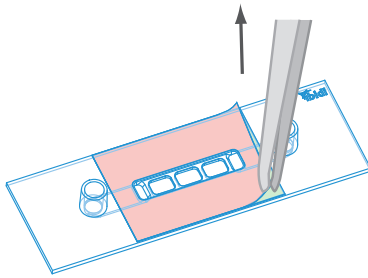

- Fill each well with 16 μl liquid gel. Avoid air bubbles. Optimize the gel volume for best results. See section 'Gel Volume Optimization' on page 2 for details.

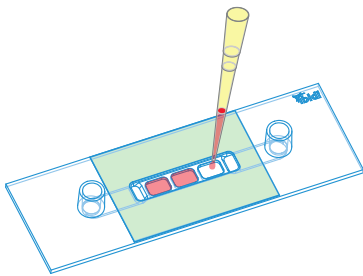

- Place the coverslip on the sticky part of the slide. Make sure the adhesive area between is tightly sealed. Therefore, press on that area to tighten the connection.

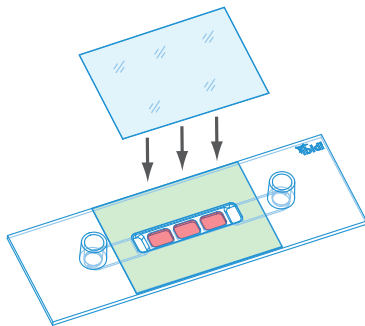

- Cover the Luer adapters with the supplied caps to maintain sterility.
- Let the gel polymerize under appropriate conditions.
- Prepare your cell suspension and dilute to the desired concentration. Depending on your cell type, application of a $2-4.5 \times 10^5$ cells/ml suspension should result in a confluent layer within 2-3 days. For endothelial cells under flow conditions we recommend a high concentration of $0.8-1.6 \times 10^6$ cells/ml for 100% optical confluency after cell attachment.
- Apply ca. 250 μl cell suspension into the channel by using a biocompatible 1 ml syringe. Connect the syringe directly to the Luer port. Filling the syringe with ca. 500 μl cell suspension helps avoiding air bubbles.

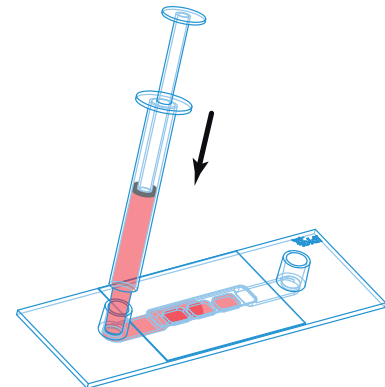

- Remove all leftover cell suspension from the Luer adapters with a normal pipette tip. Take care not to remove the cell suspension from the channel by pipetting away from the channel in the Luer adapter.
- Cover the Luer adapters with the supplied caps to maintain sterility.
- Incubate at 37°C and 5% CO₂ and wait for cell attachment.
- After cell attachment fill each Luer adapter with 60 μl medium.
- The μ-Slide is now ready for applying flow conditions on the adherent cells.

Tip:

The day before seeding the cells we recommend placing the cell medium and the μ-Slide into the incubator for equilibration. This will prevent the liquid inside the channel from emerging air bubbles over the incubation time.

Connecting Tubing for Perfusion

The μ-Slide is fully compatible with the ibidi Pump System and other pump setups.

Detailed information about flow rates, shear stress, and shear rates is provided in [Application Note 11 "Shear stress and shear rates"](#). Suitable Tube Adapter Sets are also available (see page 6). They consist of a tubing (20 cm) with inner diameter of 1.6 mm and adapters for the connection between the ibidi μ-Slide (female Luer) and the tubing of the pump in use.

- Fill both Luer ports with cell-free medium until they are completely filled. This ensures air bubble-free connection of the tubing.

2. Prepare the perfusion system by 1) filling the tubing completely and 2) pinching off the tubing a screw clamp or a hose clip.
3. Connect the male Luer ends of the clamped tubing to the Luer ports one at a time. Make sure not to trap air. Remove access culture medium with tissue.

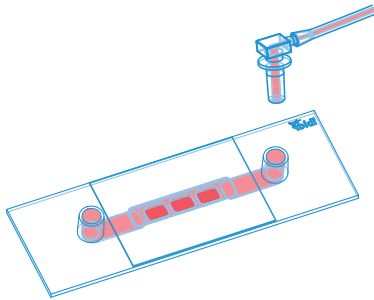

4. Open the clamped tubing and conduct your perfusion experiment.

Shear Stress

For perfusion of the channel, the shear stress (τ) can be calculated by inserting the flow rate (Φ) and the dynamical viscosity of the medium (η) in the following formula:

$$\tau \left[\frac{\text{dyn}}{\text{cm}^2} \right] = \eta \left[\frac{\text{dyn}\cdot\text{s}}{\text{cm}^2} \right] \cdot 60.1 \cdot \Phi \left[\frac{\text{ml}}{\text{min}} \right]$$

For simplicity, the calculation includes conversions of units (not shown).

Medium Exchange

Take care, that the channel never falls dry during the exchange process. This helps you avoiding air bubbles.

1. If the μ-Slide I Luer 3D is connected to a pump, disconnect the tubing from the channel first.
2. Remove all liquid from the Luer ports with a normal pipette tip. Take care not to remove the liquid from the channel by pipetting away from the channel in the Luer port.
3. Apply 150 μl new solution into one Luer port.

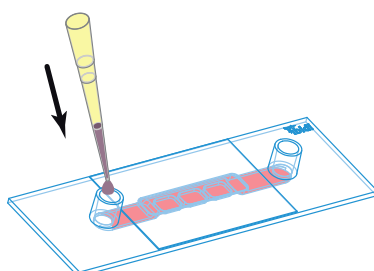

4. Slowly remove 150 μl from the opposite Luer port. Point the pipet tip towards the channel inlet making a connection to the liquid. This will replace the liquid in the channel.

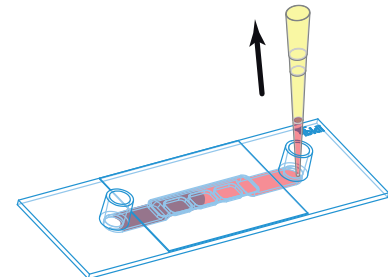

5. Repeat the medium exchange if necessary.
6. Fill each Luer port with 60 μl cell-free medium. For reconnecting tubing, fill both Luer ports until they are completely full and meniscus-free.
7. Continue with your experiment.

Important!

Take care, that the channel never falls dry during the exchange process. This helps you avoiding air bubbles.

Microscopy

To analyze your cells, no special preparations are necessary. Cells can be directly observed live or fixed, preferably on an inverted microscope. The bottom cannot be removed. For optimal results in fluorescence microscopy and storage of fixed and stained samples, ibidi provides a mounting medium (50001) optimized for μ-Dishes, μ-Slides, and μ-Plates.

The μ-Slide I Luer 3D is partially compatible with upright microscopy. Please keep in mind that there is limited space between the Luer adapters.

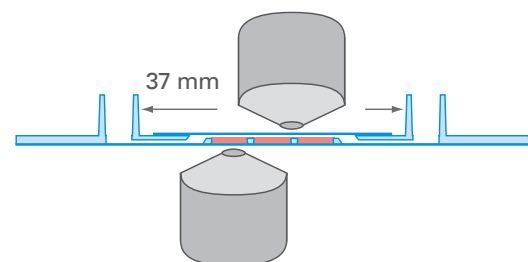

Please also keep in mind the working distance of the objective lenses. Focusing cells on the gel matrix with upright objective lenses needs a minimal working distance of

ca. 0.6 mm. With inverted objective lenses, the minimal working distance is ca. 0.8 mm.

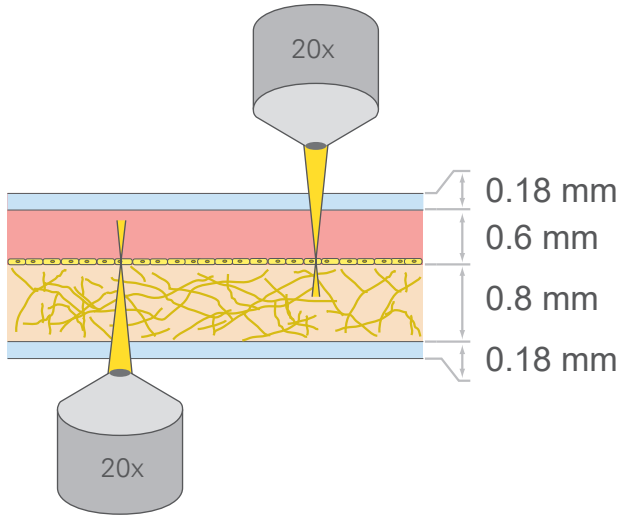

Chemical Compatibility

The following table provides some basic information on the chemical and solvent compatibility of the μ-Slide I Luer 3D. For a full list of compatible solvents and more information on chemical compatibility, please visit the FAQ section on ibidi.com.

Chemical / Solvent	Compatibility
Methanol	yes
Ethanol	yes
Formaldehyde	yes
Acetone	no
Mineral oil	no
Silicone oil	yes
Immersion oil	See Immersion Oil on page 6.

Immersion Oil

When using oil immersion objectives with the ibidi Polymer Coverslip, use only the immersion oils specified in the table below. The use of any non-recommended oil could damage the ibidi Polymer Coverslip. The resulting leakage may harm objectives and microscope components. All immersion oils that are not listed in the table below should be considered as non-compatible.

Company	Product	Ordering No.	Lot Number	Test Date
ibidi	ibidi Immersion Oil	50101	16-12-27	01/2017
Cargille	Type A	16482	100592	01/2017
Cargille	Type HF	16245	92192	01/2017
Carl Roth	Immersion oil	X899.1	414220338	01/2017
Leica	Immersion Liquid	11513859	n.a.	03/2011
Nikon	Immersion Oil F2 30cc	MXA22192	n.a.	01/2020
Nikon	Silicone Immersion Oil 30cc	MXA22179	20191101	01/2020
Olympus	Silicone Immersion Oil	SIL300CS-30CC	N4190800	01/2017
Zeiss	Immersionol 518 F	444960	160706	01/2017
Zeiss	Immersionol W 2010	444969	101122	04/2012

Ordering Information

The μ-Slide I Luer 3D is available in two product versions.

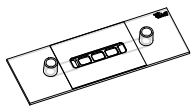

Cat. No.	Description
87171	μ-Slide I Luer 3D Uncoated: #1.5 polymer coverslip, hydrophobic, sterilized
87176	μ-Slide I Luer 3D ibiTreat: #1.5 polymer coverslip, tissue culture treated, sterilized

Tube Adapter Set

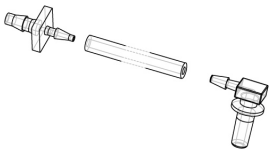

Cat. No.	Description
10831	Tube Adapter Set: sterilized

For research use only!

Further information can be found at www.ibidi.com. For questions and suggestions please contact us by e-mail info@ibidi.de or by telephone +49 (0)89/520 4617 0.

© ibidi GmbH, Lochhamer Schlag 11, 82166 Gräfelfing, Germany.