

The ibidi product family is comprised of a variety of μ-Slides and μ-Dishes, which have all been designed for high-end microscopic analysis of fixed or living cells. The high optical quality of the material is similar to that of glass, so you can perform all kinds of fluorescence experiments with uncompromised resolution and choice of wavelength.

The μ-Slide Membrane ibiPore Flow allows you to perform several cell culture assays with a porous glass membrane.

The main application is the culture of cells on the membrane, optionally under flow conditions in the lower channel. Cells and gel matrices in the upper channel, above the membrane are possible applications as well. Trans-membrane perfusion setups, filter assays and applications with perfusion in both channels are not possible.

Contents

Material	2
Shipping and Storage	2
Geometry	2
Surfaces	3
Microscopy	3
Chemical Compatibility	3
Additional Material	3
General Handling	4
Coating	5
Seeding Cells on the Membrane's Lower Side	6
Seeding Cells on the Membrane's Upper Side	7
Seeding a Gel Matrix inside the Upper Channel	8
Connecting Tubing for Perfusion	8
Shear Stress	8
Medium Exchange in the Upper Channel	9
Medium Exchange in the Lower Channel	9
Notes	11
Immersion Oil	11
Ordering Information	12

Material

ibidi μ-Slides, μ-Dishes, and μ-Plates are made of a polymer that has the highest optical quality. The polymer coverslip on the bottom exhibits extremely low birefringence and autofluorescence, similar to that of glass. Also, it is not possible to detach the bottom from the upper part. The μ-Slides, μ-Dishes, and μ-Plates are intended for one-time use and are not autoclavable, since they are only temperature-stable up to 80°C/175°F. Please note that gas exchange between the medium and the incubator's atmosphere occurs partially through the polymer coverslip, which should not be covered.

Optical Properties ibidi Polymer Coverslip

Refractive index n_D (589 nm)	1.52
Abbe number	56
Thickness	No. 1.5 (180 μm)
Material	Polymer coverslip

Please note! The ibidi Polymer Coverslip is compatible with certain types of immersion oil only. A list of suitable oils can be found on page 11.

Shipping and Storage

The μ-Slides, μ-Dishes and μ-Plates are sterilized and welded in a gas-permeable packaging. The shelf life under proper storage conditions (in a dry place, no direct sunlight) is listed in the following table.

Conditions	
Shipping conditions	Ambient
Storage conditions	RT (15–25°C)
Shelf Life	
ibiTreat	36 months

Geometry

The μ-Slide Membrane ibiPore Flow provides standard slide format according to ISO 8037/1. The principle of the μ-Slide consists of a horizontal glass membrane inserted between two channels. The upper channel (D) is a static reservoir above the glass membrane. The lower channel (E) is a perfusion channel for applying defined shear stress. The air-filled pressure compensation channel (F)

buffers pressure changes, thus assuring convenient handling and membrane stability. The upper and the lower channel communicate with each other across the membrane only.

Geometry of the μ-Slide Membrane ibiPore Flow

Total coating area	4.50 cm ²
Bottom	ibidi Standard Bottom
Lower Channel (Main Channel)	
Access	Luer port, accessible with female Luers
Volume	50 μl
Height	0.4 mm
Length	25 mm
Width	5 mm
Growth area	1.25 cm ²
Upper Channel	
Access	Reservoir port, accessible with 20/200 μl pipet tips
Volume	55 μl
Height over membrane	1.3 mm

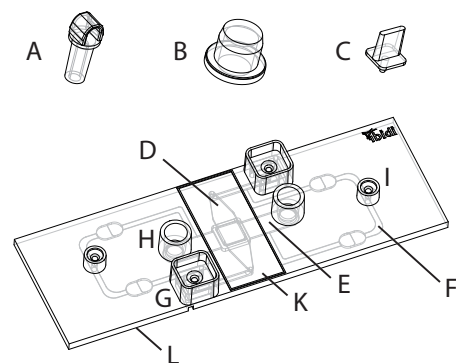

- A: Luer Plug (2x)
- B: Luer Cap (2x)
- C: Small Plug (4x)
- D: Upper Channel (=above membrane)
- E: Lower Channel (=below membrane)
- F: Pressure Compensation Channel
- G: Reservoir Port for Upper Channel
- H: Luer Port for Lower Channel
- I: Access Port for Pressure Compensation Channel
- K: Glass Coverslip
- L: ibidi Polymer Coverslip

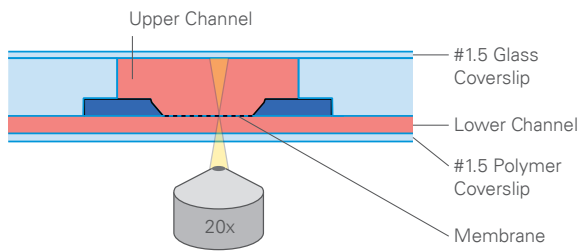

Cross section of the μ-Slide Membrane ibiPore Flow

Geometry of the Membrane

Material	SiO ₂ (glass)			
Thickness	0.3 μm (300 nm)			
Membrane size	2 mm × 2 mm			
Porous area	1.77 mm × 1.84 mm			
Restrictions for objective lenses	Working distance >0.5 mm			
Pore layout	Hexagonal spacing			
Available variations				
Pore Size	0.5 μm	3 μm	5 μm	8 μm
Porosity	20%	5%	5%	5%
Pore-to-pore distance	1 μm	12 μm	20 μm	32 μm

Surfaces

The μ-Slide Membrane ibiPore Flow is available with the ibiTreat surface. ibiTreat is a physical treatment and optimized for adhesion of most cell types. Many cell lines as well as primary cells were tested for good cell growth. The porous membrane is an uncoated glass membrane. Protein coatings may increase direct cell growth of adherent cells on the glass membrane.

Microscopy

To analyze your cells, no special preparations are necessary. Cells can be directly observed live or fixed, preferably on an inverted microscope. The bottom cannot be removed. For optimal results in fluorescence microscopy and storage of fixed and stained samples, ibidi provides a mounting medium (50001) optimized for μ-Dishes, μ-Slides, and μ-Plates.

Important!

Due to the channel height of 0.4 mm the glass membrane can be imaged only with objective lenses with a working distance higher than 0.5 mm.

Important!

Please keep in mind: The small 0.5 μm pores are not visible in the cell culture microscope.

Chemical Compatibility

The following table provides some basic information on the chemical and solvent compatibility of the μ-Slide Membrane ibiPore Flow. For a full list of compatible solvents and more information on chemical compatibility, please visit the FAQ section on ibidi.com.

Chemical / Solvent	Compatibility
Methanol	yes
Ethanol	yes
Formaldehyde	yes
Acetone	yes, without lid
Mineral oil	no
Silicone oil	yes
Immersion oil	See Immersion Oil on page 11.

Additional Material

The following material is required for correctly using the μ-Slide Membrane ibiPore Flow. The material from the list below is already included in the kit products. See page 12 for ordering information.

- Compatible 10-200 μl pipet tips. See list below for compatible models.
- Sterile Petri dish, e.g. 10 cm.
- Sterile 1 ml syringe with male Luer tip.

List of Compatible Pipet Tips

Supplier	Ordering Number
Greiner Bio-One	739261, 739280, 739290, 772288 or related beveled Greiner tips
Axygen	T-200-C, TR-222-C, TR-222-Y or related Axygen beveled tips
STARLAB	TipOne RPT S1161-1800 or related beveled TipOne tips
Sorenson BioScience	MulTi Fit Tip 10590, 15320, 15330 or related beveled Sorenson BioScience tips



Example beveled pipet tip, see list for correct models

Important!

Strictly follow the instructions in this document. All steps are essential for successful handling. Modifications in the protocol might lead to air bubbles, cell damage or membrane disruption.

General Handling

Always handle the μ-Slide Membrane ibiPore Flow carefully because the porous glass membrane can be easily damaged by abrupt pressure changes.

Connect plugs, tubing and pump connectors carefully.

Check the integrity of the membrane microscopically before starting an experiment.

The μ-Slide Membrane ibiPore Flow should not be placed directly on cold or metal surfaces to avoid rapid cool down of medium and cells. Fast temperature changes promote the formation of air bubbles and cell stress leading to cell detachment and apoptosis. Always put the μ-Slide Membrane ibiPore Flow on a μ-Slide Rack (ibidi, 80003) or inside a sterile 10 cm Petri dish.

Use sterile-filtered medium to avoid optical impairment of the membrane caused by non-soluble components of the culture medium or serum.

The day before seeding the cells we recommend placing the cell medium and the μ-Slide into the incubator for equilibration. This overnight incubation will prevent the liquid from emerging air bubbles. The packaging of the μ-Slide is made of a gas-permeable material therefore unpacking is not necessary for the gas equilibration step.

Coating

The following protocol provides a procedure for coating the μ-Slide Membrane ibiPore Flow with different protein matrices. Most cells, particularly primary cells, will require protein matrices such as collagen or fibronectin to promote cell adherence and growth on the porous glass membrane. For optimal cell adherence we recommend the use of the cell culture coating established in your lab and also reviewing literature.

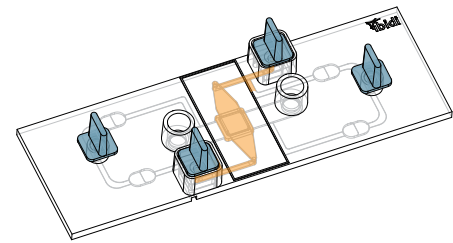

1. Close the lower channel (E) with the Luer plugs (A).
2. Close the access ports (I) of both pressure compensation channels (F) with the small plugs (C).
3. Prepare your coating solution according to the manufacturer's specifications or reference. Adjust the concentration to a coating area of 4.5 cm² and a volume of 105 μl.
4. Fill 55 μl of the coating solution into the upper channel (D) using the reservoir port (G). Use a standard pipet with the recommended pipet tips.

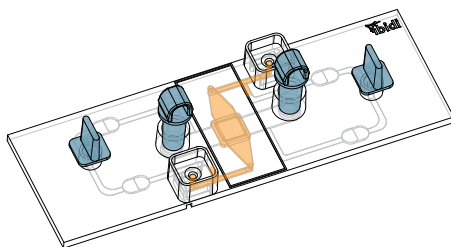
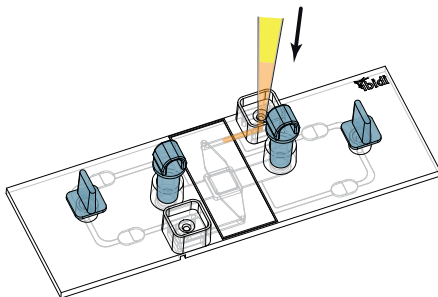

5. Close both reservoir ports (G) with the small plugs (C).

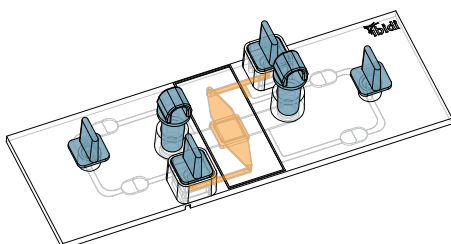

6. Remove the Luer plugs (A) from the Luer ports (H).

7. Apply ca. 150 μl of the coating solution into the lower channel (E) by using a biocompatible 1 ml syringe. Filling the syringe with ca. 300 μl solution helps avoiding air bubbles. See Note 3.

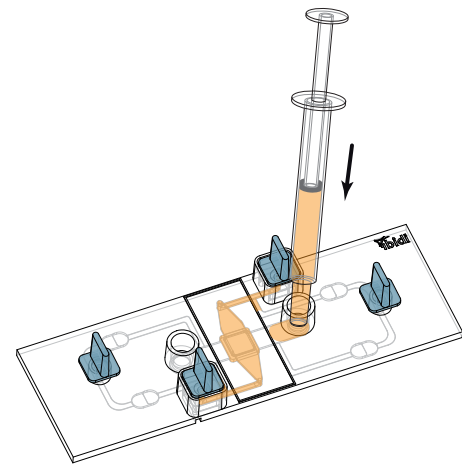

8. Remove leftover coating solution from the Luer ports with a normal pipette.

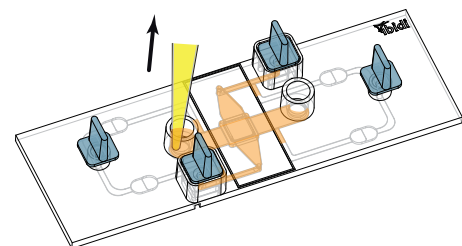

9. Put the slide into a sterile 10 cm Petri dish and leave at room temperature for at least 30 minutes.

10. Wash with PBS or medium. For this, follow the protocol in the section 'Medium Exchange in the Upper Channel' (page 9) and 'Medium exchange in the Lower Channel' (page 9).

11. Aspirate the remaining solution completely.

12. Let dry at room temperature.

Important!

For proper handling after coating and washing, all channels must be completely dry!

Seeding Cells on the Membrane's Lower Side

To perform assays with cells on the lower side of the Membrane follow the steps in the protocol below. For best result, carefully follow the protocol in a precise way. Do not change the order of pipetting, volumes, plug positions or conduct any other modifications.

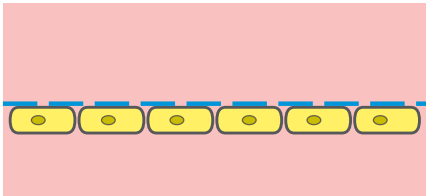

1. Close the lower channel (E) with the Luer plugs (A).
2. Close the access ports (I) of both pressure compensation channels (F) with the small plugs (C).
3. Fill the upper channel (D) by gently injecting 55 μl cell-free medium into one of the reservoir ports (G). Press the pipette tip into reservoir port (G) and hold the pipette upright to create a seal. Inject medium until the entire channel is filled. See Note 1 and 2.

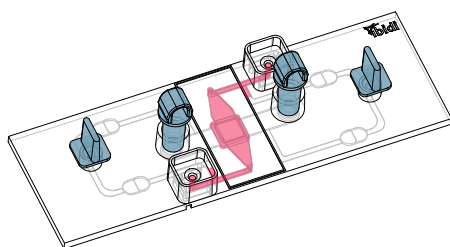
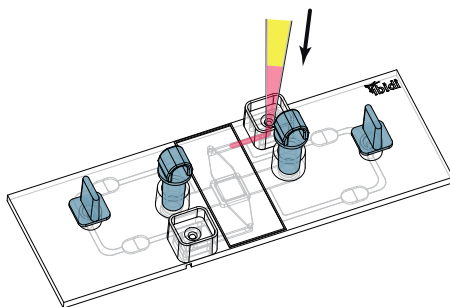

4. Close both reservoir ports (G) with the small plugs (C).

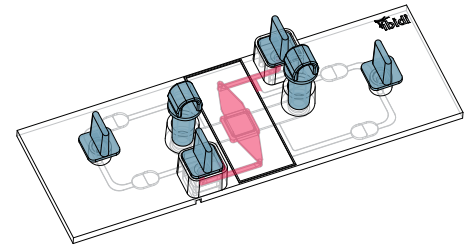

5. Remove the Luer plugs (A) from the Luer ports (H).

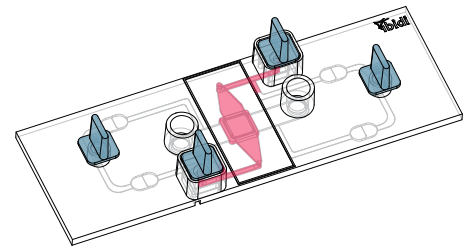

Important!

Fill the upper channel only one time. Re-filling the upper channel may lead to a trapped air bubble. For a medium exchange in the upper channel, follow the protocol on page 9.

6. Prepare your cell suspension and dilute to the desired concentration. Depending on your cell type, application of a $3-7 \times 10^5$ cells/ml suspension should result in a confluent layer within 2-3 days. For endothelial cells under flow conditions we recommend a high concentration of $1.2-2.5 \times 10^6$ cells/ml for 100% optical confluency after cell attachment.
7. Apply ca. 150 μl cell suspension into the lower channel (E) by using a biocompatible 1 ml syringe. Filling the syringe with ca. 300 μl cell suspension helps avoiding air bubbles. See Note 3.

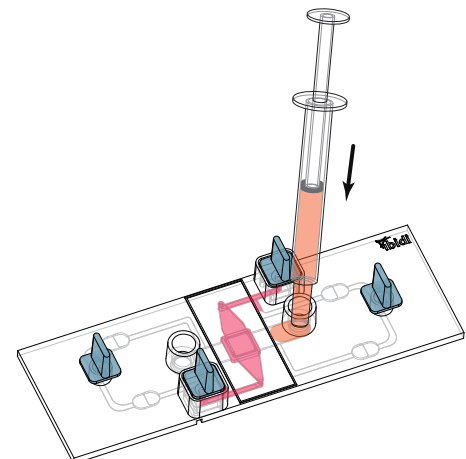

8. Remove all cell suspension from the Luer ports (H) with a normal pipette tip. Take care not to remove the cell suspension from the channel by pipetting away from the channel in the Luer port.

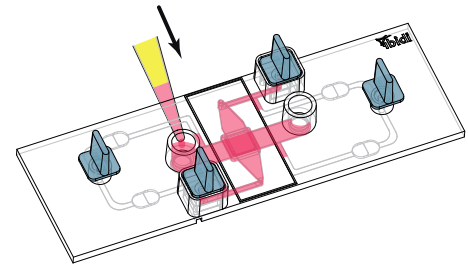
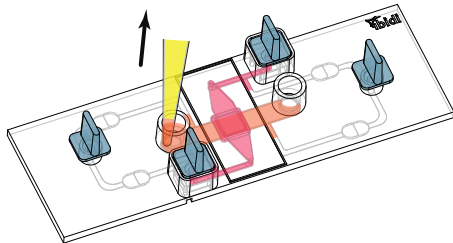

17. Cover the Luer ports (H) with the Luer caps (B) to maintain sterility.

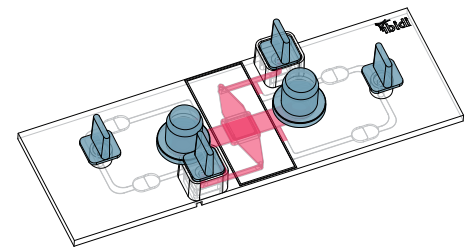

9. Cover the Luer ports (H) using the Luer caps (B). Do not use the Luer plugs (A) in this step.

10. Put the μ-Slide into a sterile 10 cm Petri dish with wet tissue. This ensures high humidity and low evaporation during the cell attachment. See note 4.

11. Close the Petri dish.

12. Turn the Petri dish **upside down (!)** in order to let the cells attach downside of the membrane. Without this rotation step, the cells will not attach on the membrane but rather on the bottom of the channel.

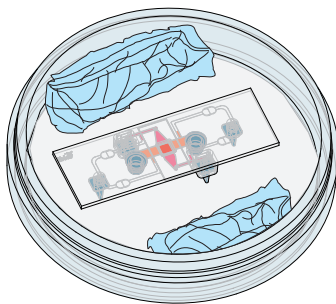

13. Put the Petri dish into the incubator for cell adhesion. Incubate at 37°C and 5% CO₂ as usual.

14. Await cell attachment. Observe the cell attachment under the phase contrast microscope leaving the μ-Slide inside the Petri dish.

15. After cell attachment, rotate the μ-Slide again.

16. Fill each Luer port (H) with 60 μl cell-free medium. (For flow applications, fill the Luer port (H) until it is completely full and meniscus-free (80 μl). Continue on page 8 for connecting tubing and pumps.)

18. Conduct your experiment.

Tip!

The day before seeding the cells we recommend placing the cell medium and the μ-Slide into the incubator for equilibration. This will prevent the liquid inside the channel from emerging air bubbles over the incubation time.

Tip!

For longer cultivation under static conditions, medium exchange at regular intervals or a gentle flow are necessary. The latter can also be achieved by an incubator-compatible cell culture rocker.

Seeding Cells on the Membrane's Upper Side

Follow the steps in the protocol below to perform assays with cells on the upper side of the Membrane.

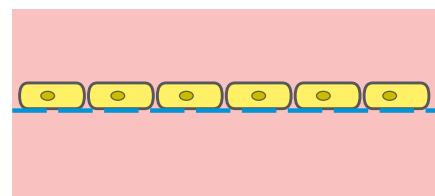

Follow all steps and the order of pipetting from the section ‘Seeding Cells on the Membrane’s Lower Side’ on page 6 but change the following points:

1. For filling the upper channel, use a cell suspension with a concentration of $0.9\text{-}2.1 \times 10^5$ cells/ml resulting in a confluent layer within 2-3 days. For 100% optical confluency after cell attachment we recommend a higher concentration of $3.5\text{-}7.5 \times 10^5$ cells/ml.
2. For filling the lower channel, use culture medium. The upside-down cultivation step is not necessary.

Seeding a Gel Matrix inside the Upper Channel

Follow the steps in the protocol below to perform assays with a gel matrix inside the upper channel.

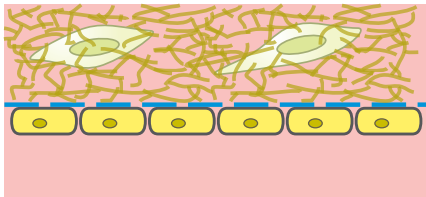

Follow all steps and the order of pipetting from the section ‘Seeding Cells on the Membrane’s Lower Side’ on page 6 but change the following points:

1. For filling the upper channel, use a liquid gel matrix, optionally mixed with cells.
2. Let the gel matrix polymerize according to your gel protocol.
3. For filling the lower channel, use culture medium. Alternatively use a cell suspension to attach a cell monolayer to the membrane’s lower side.

Connecting Tubing for Perfusion

The μ-Slide Membrane ibiPore Flow can be perfused in the lower chamber for shear stress and flow applications. The μ-Slide is fully compatible with the ibidi Pump System and other pump setups. Please note that the upper channel cannot be perfused with liquid.

Detailed information about flow rates, shear stress, and shear rates is provided in [Application Note 11 “Shear stress and shear rates”](#). Suitable Tube Adapter Sets are also available (see page 12). They consist of a tubing (20 cm) with inner diameter of 1.6 mm and adapters for the connection between the ibidi μ-Slide (female Luer) and the tubing of the pump in use.

1. Fill both Luer ports (H) with cell-free medium until they are completely filled (80 μl). This ensures air bubble-free connection of the tubing.

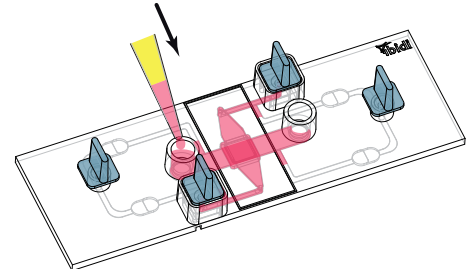

2. Prepare the perfusion system by 1) filling the tubing completely and 2) pinching off the tubing with the ibidi Screw Clamp (ibidi, 10861) or a similar Hoffmann tubing clamp. See note 5.



3. Connect the male Luer ends of the clamped tubing to the Luer ports (H) one at a time. Make sure not to trap air. Remove access culture medium with tissue. See note 6.

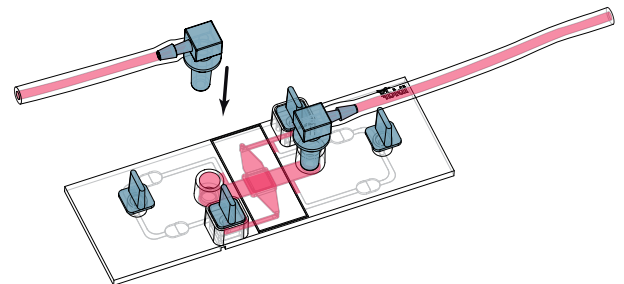

4. Open the clamped tubing slowly by gradually unscrewing the clamp. This is essential to minimize pressure peaks within the channel.
5. Conduct your perfusion experiment leaving all small plugs (C) in place.

Important!

Applying liquid perfusion to the **upper** channel is not recommended. This is due to the different channel heights which create different shear stress conditions in the upper channel.

Liquid flow and shear stress in the **lower** channel is homogeneous over the channel’s and membrane’s surface.

Shear Stress

For perfusion of the lower channel, the shear stress (τ) can be calculated by inserting the flowrate (Φ) and the dynamical viscosity of the medium (η) in the following formula:

$$\tau \left[\frac{\text{dyn}}{\text{cm}^2} \right] = \eta \left[\frac{\text{dyn}\cdot\text{s}}{\text{cm}^2} \right] \cdot 131.6 \cdot \Phi \left[\frac{\text{ml}}{\text{min}} \right]$$

For simplicity, the calculation includes conversions of units (not shown).

Medium Exchange in the Upper Channel

Take care, that the channel never falls dry during the exchange process. This helps you avoiding air bubbles.

- Close the lower channel (E) with the Luer plugs (A). If the μ-Slide is connected to tubing, pinch off the tubing on both sides of the channel using a Hoffmann tubing clamp.
- Remove the small plugs (C) from the reservoir ports (G).

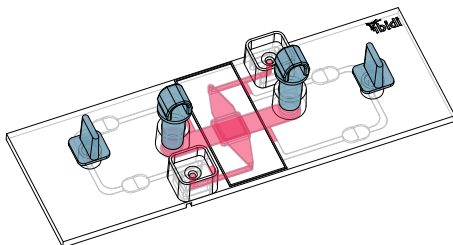

- Put 60 μl new solution on top of one reservoir port (G) of the upper channel. Do not inject directly. Make sure not to trap or inject air.

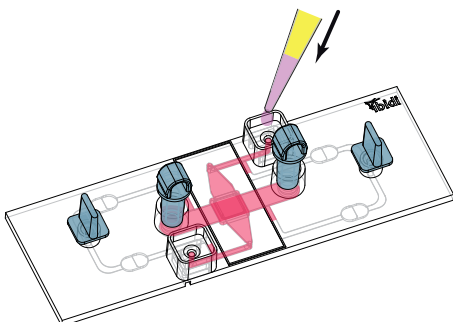

- Slowly remove 60 μl from the opposite reservoir port (G). Aspirate by pressing the pipette tip upright into the reservoir port to create a seal. This will replace the liquid in the upper channel.

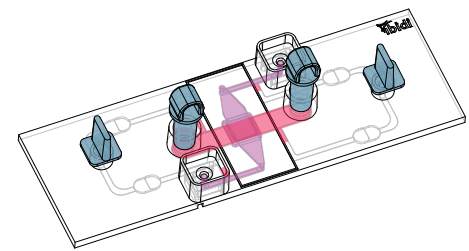
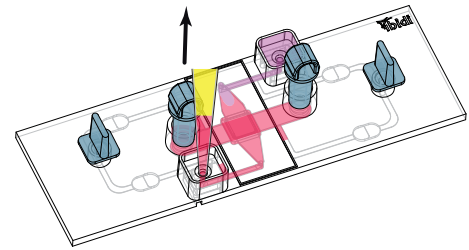

- Repeat the medium exchange if necessary.
- Close the reservoir ports (G) with the small plugs (C).
- Continue with your experiment.

Important!

Take care, that the channel never falls dry during the exchange process. This helps you avoiding air bubbles.

Medium Exchange in the Lower Channel

Take care, that the channel never falls dry during the exchange process. This helps you avoiding air bubbles.

- If the lower channel (E) is connected to tubing, pinch off the tubing on both sides of the channel using the ibidi Screw Clamp (ibidi, 10861) or a similar Hoffmann tubing clamp.
- Make sure the reservoir ports (G) are closed with the small plugs (C).
- Disconnect the tubing from the lower channel (E).
- Remove all liquid from the Luer ports (H) with a normal pipette tip. Take care not to remove the liquid from the channel by pipetting away from the channel in the Luer port.

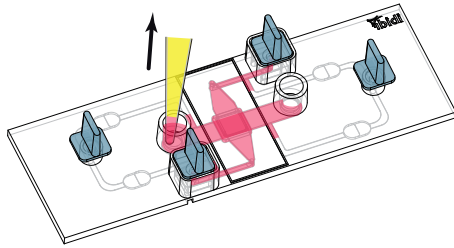

- Apply 100 μl new solution into one Luer port (H).

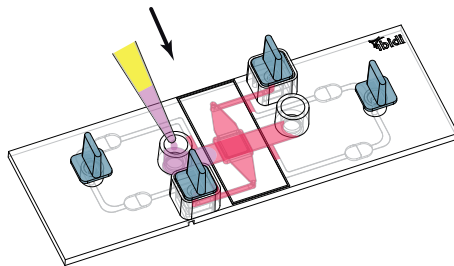

- Slowly remove 100 μl from the opposite Luer port. Point the pipet tip towards the channel inlet making a connection to the liquid. This will replace the liquid in the lower channel.

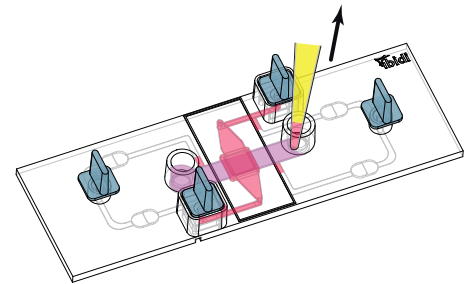

- Repeat the medium exchange if necessary.
- Fill each Luer port (H) with 60 μl cell-free medium. For flow applications, fill this port until it is completely full and meniscus-free (80 μl).
- Continue with your experiment.

Important!

Take care, that the channel never falls dry during the exchange process. This helps you avoiding air bubbles.

Notes

1. For injection of liquid, press the pipet tip onto the opening creating a tight connection. Hold the pipet tip in an exact upright position to facilitate the injection process. Placing the liquid onto the opening without injection will not fill the channel properly.
2. The amount of liquid ending up in the pressure compensation channel is flexible. In case the amount of air inside the pressure compensation channel must be adjusted, open the port and adjust the air volume with a pipette.
3. Applying the cell suspension with a 1 ml syringe leads to proper channel filling. A normal pipet provides insufficient force to fill the entire channel conveniently.
4. A humid chamber helps avoiding evaporation and supports cell attachment inside cell culture incubators. We recommend using a sterile 10 cm Petri dish with wet tissue.
5. Always use a screw clamp or a similar Hoffmann tubing clamp which releases the pressure slowly. Do not use quick-release pinching clamps like the ibidi Hose Clip (ibidi, 10821). Those can lead to pressure peaks leading to cell and membrane damage.
6. The correct and air-bubble free flow connection will cause minor medium spillage. This spillage can be soaked with tissue keeping the inside of the channel/tubing under sterile conditions.

Immersion Oil

When using oil immersion objectives with the ibidi Polymer Coverslip, use only the immersion oils specified in the table below. The use of any non-recommended oil could damage the ibidi Polymer Coverslip. The resulting leakage may harm objectives and microscope components. All immersion oils that are not listed in the table below should be considered as non-compatible.

Company	Product	Ordering No.	Lot Number	Test Date
ibidi	ibidi Immersion Oil	50101	16-12-27	01/2017
Cargille	Type A	16482	100592	01/2017
Cargille	Type HF	16245	92192	01/2017
Carl Roth	Immersion oil	X899.1	414220338	01/2017
Leica	Immersion Liquid	11513859	n.a.	03/2011
Nikon	Immersion Oil F2 30cc	MXA22192	n.a.	01/2020
Nikon	Silicone Immersion Oil 30cc	MXA22179	20191101	01/2020
Olympus	Silicone Immersion Oil	SIL300CS-30CC	N4190800	01/2017
Zeiss	Immersionol 518 F	444960	160706	01/2017
Zeiss	Immersionol W 2010	444969	101122	04/2012

Ordering Information

The μ-Slide Membrane ibiPore Flow is available in different product versions.

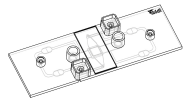

Cat. No.	Description	Pcs./Box
85116	μ-Slide Membrane ibiPore^{0.5 μm/20%} Flow ibiTreat: #1.5 polymer coverslip, tissue culture treated, 0.5 μm porous glass membrane, 20% porosity, sterilized	10
85126	μ-Slide Membrane ibiPore^{3.0 μm/5%} Flow ibiTreat: #1.5 polymer coverslip, tissue culture treated, 3.0 μm porous glass membrane, 5% porosity, sterilized	10
85136	μ-Slide Membrane ibiPore^{5.0 μm/5%} Flow ibiTreat: #1.5 polymer coverslip, tissue culture treated, 5.0 μm porous glass membrane, 5% porosity, sterilized	10
85146	μ-Slide Membrane ibiPore^{8.0 μm/5%} Flow ibiTreat: #1.5 polymer coverslip, tissue culture treated, 8.0 μm porous glass membrane, 5% porosity, sterilized	10
85116-S	μ-Slide Membrane ibiPore^{0.5 μm/20%} Flow ibiTreat Trial Pack: #1.5 polymer coverslip, tissue culture treated, 0.5 μm porous glass membrane, 20% porosity, sterilized	2
85126-S	μ-Slide Membrane ibiPore^{3.0 μm/5%} Flow ibiTreat Trial Pack: #1.5 polymer coverslip, tissue culture treated, 3.0 μm porous glass membrane, 5% porosity, sterilized	2
85136-S	μ-Slide Membrane ibiPore^{5.0 μm/5%} Flow ibiTreat Trial Pack: #1.5 polymer coverslip, tissue culture treated, 5.0 μm porous glass membrane, 5% porosity, sterilized	2
85146-S	μ-Slide Membrane ibiPore^{8.0 μm/5%} Flow ibiTreat Trial Pack: #1.5 polymer coverslip, tissue culture treated, 8.0 μm porous glass membrane, 5% porosity, sterilized	2

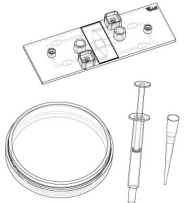

Cat. No.	Description	Pcs./Box
85116-KIT	μ-Slide Membrane ibiPore^{0.5 μm/20%} Flow ibiTreat - KIT: #1.5 polymer coverslip, tissue culture treated, 0.5 μm porous glass membrane, 20% porosity, sterilized, including pipet tips, syringes and petri dishes	10
85126-KIT	μ-Slide Membrane ibiPore^{3.0 μm/5%} Flow ibiTreat - KIT: #1.5 polymer coverslip, tissue culture treated, 3.0 μm porous glass membrane, 5% porosity, sterilized, including pipet tips, syringes and petri dishes	10
85136-KIT	μ-Slide Membrane ibiPore^{5.0 μm/5%} Flow ibiTreat - KIT: #1.5 polymer coverslip, tissue culture treated, 5.0 μm porous glass membrane, 5% porosity, sterilized, including pipet tips, syringes and petri dishes	10
85146-KIT	μ-Slide Membrane ibiPore^{8.0 μm/5%} Flow ibiTreat - KIT: #1.5 polymer coverslip, tissue culture treated, 8.0 μm porous glass membrane, 5% porosity, sterilized, including pipet tips, syringes and petri dishes	10
85116-S-KIT	μ-Slide Membrane ibiPore^{0.5 μm/20%} Flow ibiTreat - Trial Pack - KIT: #1.5 polymer coverslip, tissue culture treated, 0.5 μm porous glass membrane, 20% porosity, sterilized, including pipet tips, syringes and petri dishes	2
85126-S-KIT	μ-Slide Membrane ibiPore^{3.0 μm/5%} Flow ibiTreat - Trial Pack - KIT: #1.5 polymer coverslip, tissue culture treated, 3.0 μm porous glass membrane, 5% porosity, sterilized, including pipet tips, syringes and petri dishes	2
85136-S-KIT	μ-Slide Membrane ibiPore^{5.0 μm/5%} Flow ibiTreat - Trial Pack - KIT: #1.5 polymer coverslip, tissue culture treated, 5.0 μm porous glass membrane, 5% porosity, sterilized, including pipet tips, syringes and petri dishes	2
85146-S-KIT	μ-Slide Membrane ibiPore^{8.0 μm/5%} Flow ibiTreat - Trial Pack - KIT: #1.5 polymer coverslip, tissue culture treated, 8.0 μm porous glass membrane, 5% porosity, sterilized, including pipet tips, syringes and petri dishes	2

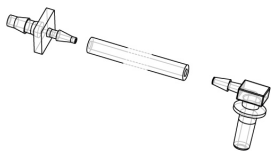
Tube Adapter Set

Cat. No.	Description
10831	Tube Adapter Set: sterilized

For research use only!